

User's Manual

FlexScan® L351

Color LCD Monitor



SAFETY SYMBOLS

This manual uses the safety symbols below. They denote critical information. Please read them carefully.



WARNING

Failure to abide by the information in a WARNING may result in serious injury and can be life threatening.



CAUTION

Failure to abide by the information in a CAUTION may result in moderate injury and/or property or product damage.



Indicates a prohibited action.



Indicates to ground for safety.

Copyright© 2000 by EIZO NANA0 CORPORATION. All rights reserved. No part of this manual may be reproduced, stored in a retrieval system, or transmitted, in any form or by any means, electronic, mechanical, or otherwise, without the prior written permission of Eizo Nanao Corporation.

Eizo Nanao Corporation is under no obligation to hold any submitted material or information confidential unless prior arrangements are made pursuant to Eizo Nanao Corporation's receipt of said information. Although every effort has been made to ensure that this manual provides up-to-date information, please note that EIZO monitor specifications are subject to change without notice.

ENERGY STAR is a U.S. registered mark.

VESA is a registered trademark of Video Electronics Standards Association.

VGA is a registered trademark of International Business Machines Corporation.

ScreenManager and PowerManager are trademarks of Eizo Nanao Corporation.

FlexScan and EIZO are registered trademarks of Eizo Nanao Corporation.



As an ENERGY STAR® Partner, Eizo Nanao Corporation has determined that this product meets the ENERGY STAR guidelines for energy efficiency.

TABLE OF CONTENTS

 PRECAUTIONS	4
1. INTRODUCTION	10
1-1. Features	10
1-2. Package Contents	10
1-3. Controls & Connectors	11
2. CABLE CONNECTION	12
2-1. Before Connecting	12
2-2. Connecting the Signal Cable	12
3. ScreenManager	14
3-1. How to use the ScreenManager	14
3-2. ScreenManager Adjustments and Settings	15
3-3. Useful Functions	15
4. ADJUSTMENT	17
4-1. Screen Adjustment	17
4-2. Power-save Setup	19
5. ATTACHING AN ARM STAND	20
6. TROUBLE SHOOTING	22
7. CLEANING	24
8. SPECIFICATIONS	25
9. GLOSSARY	27
10. INDEX	28

PRECAUTIONS

IMPORTANT!

- ✓ This product has been adjusted specifically for use in the region to which it was originally shipped. If operated outside the region to which it was originally shipped, the product may not perform as stated in the specifications.
- ✓ To ensure personal safety and proper maintenance. Please read this section and the caution statements on the monitor (refer to the figure below).

[Location of the Caution Statements]

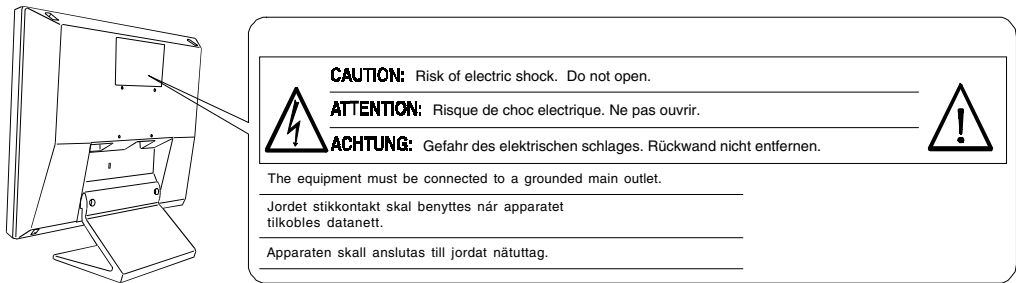

WARNING

- ✓ **If the monitor begins to emit smoke, smells like something is burning, or makes strange noises, disconnect all power connections immediately and contact your dealer for advice.**
Attempting to use a malfunctioning monitor can be dangerous.
- ✓ **Do not dismantle the cabinet or modify the monitor.**
Dismantling the cabinet or modifying the monitor may result in electric shock or burn.
- ✓ **Refer all servicing to qualified service personnel.**
Do not attempt to service this product yourself as opening or removing covers may expose you to dangerous voltage or other hazards.

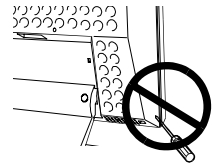

WARNING

- ✓ **To disconnect the power cord, grasp the plug firmly and pull.**
Never tug on the cord, doing so may cause damage and could result in fire or electric shock.
- ✓ **The equipment must be connected to a grounded main outlet.**
- ✓ **Use the correct voltage.**
 - * The monitor is designed for use with a specific voltage only. Connection to a different voltage may cause fire, electric shock, or other damage.
 - * Do not overload your power circuit, as this may result in fire or electric shock.
 - * For proper connections of the power cord, be certain to plug the power cord to the provided monitor connector and directly to a wall outlet. Not doing so may result in fire or electric shock.
- ✓ **Handle the power cord with care.**
 - * Do not place the cord underneath the monitor or other heavy objects.
 - * Do not pull on the cord.
 - * Do not attempt to repair a damaged cord.If the power cord becomes damaged, stop using it. Use of a damaged cord may result in fire or electric shock.
- ✓ **Never touch the plug and power cord if it begins to thunder.**
If it begins to thunder, do not touch the plug, power cord or cable. Touching them may result in electric shock.

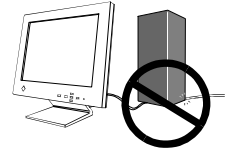
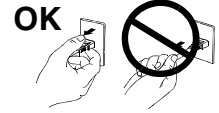

WARNING

✓ **Install the monitor securely when attaching to an arm stand.**

When attaching an arm stand, please refer to the user's manual of the arm stand and install the monitor securely with the enclosed screws. Not doing so may cause the monitor to come unattached, which may result in injury or equipment damage. When the monitor is dropped, please ask your dealer for advice. Do not continue using a damaged monitor. Using a damaged monitor may result in fire or electric shock.

When reattaching the tilt stand, please use the same screws and tighten them securely.

✓ **Do not touch a damaged LCD panel directly with bare hands.**

Use protective gloves whenever handling a damaged panel. The liquid crystal which leaks from the panel is poisonous if it enters the eyes or mouth. If any part of the skin or body comes in direct contact with the panel, please wash thoroughly. If some physical symptoms result, please consult your doctor.



✓ **Take care when disposing of the monitor.**

The backlight of the LCD panel contains mercury. Follow local regulation or laws for safe disposal.

CAUTION

• **Handle with care when carrying the monitor.**

- * Disconnect the power cord, signal cables. Moving the monitor with the cord attached is dangerous. It may result in injury or equipment damage.
- * When handling the monitor, grip the bottom of the monitor firmly with both hands ensuring the panel faces outward before lifting.
- * Handle with care to avoid scratching or damaging the panel. If the monitor becomes damaged, disconnect the power immediately and have the monitor checked by a qualified service engineer before using it again. Using a monitor after it has been dropped may result in fire or electric shock.

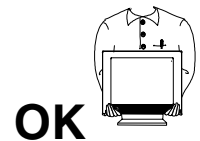

CAUTION

⌘ **Do not block the ventilation slots on the cabinet.**

- * Do not place books or any other papers on the ventilation slots.
- * Do not install the monitor in a closed space.
- * Do not use the monitor lengthwise or upside down.

Using the monitor in this way blocks the ventilation slots and prevents proper airflow, leading to fire or other damage.



• **Do not use the LCD monitor outdoors or inside a car.**

This LCD monitor has been made specifically for indoor use as a desktop monitor. Using it anywhere else may result in fire, electrical shock, or other damage.

⌘ **At the end of the day or if you plan to leave the monitor unused for an extended period after turning off the power switch, disconnect the power cord from the wall socket so that no power connections are made.**

⌘ **Do not touch the plug with wet hands.**

Touching the plug with wet hands is dangerous and can cause electrical shock.



⌘ **Use an easily accessible power outlet.**

This will ensure that you can disconnect the power quickly in case of a problem.

⌘ **Unplug the monitor before cleaning it.**

Cleaning the monitor while it is plugged into a power outlet may result in electric shock.

⌘ **Never use thinner, benzene, alcohol (ethanol, methanol, or isopropyl alcohol), abrasive cleaners, or other strong solvents, as these may cause damage to the cabinet or LCD panel.**



⌘ **Periodically clean the area around the plug.**

Buildup of dust, water, or oil on the plug may result in fire.

Suggestions for Maximizing Comfort

- ˘ **To lessen the chance of possible injury and to increase your comfort and productivity while you operate the unit, we suggest the following:**
 - * Avoid less favorable body positioning. Sit back on the chair with your back straight.
 - * Adjust the height of the chair so that the both soles touch the floor.
 - * Adjust the height of your chair, monitor, or keyboard so that you can keep your wrists straight while typing.
 - * Set the terminal slightly below eye level.
- ˘ **Adjust brightness of the screen depending on the brightness of your environment. Too dark or too bright of a screen can cause eye strain.**
- ˘ **Be sure to take adequate rests. A 10-minute rest period each hour is suggested.**

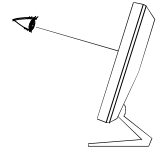

LCD Panel

- ˘ **The screen may have defective pixels. These pixels may appear as slightly light or dark area on the screen. This is due to the characteristics of the panel itself, and not the product.**
- ˘ **The backlight of the LCD panel has a fixed life span.**
When the screen becomes dark or begins to flicker, please contact your dealer.
- ˘ **Do not press on the panel or edge of the frame strongly, as this will result in damage to the screen. There will be prints left on the screen if the pressed image is dark or black. If pressure is repeatedly applied to the screen, it may deteriorate or damage your LCD panel. Leave the screen white to decrease the prints.**
- ˘ **Do not scratch or press on the panel with any sharp objects, such as a pencil or pen as this may result in damage to the panel. Do not attempt to brush with tissues as this may scratch the LCD panel.**



1. INTRODUCTION

Thank you very much for choosing an EIZO Color Monitor.

1-1. Features

- DVI ^{p.27} digital input (TMDS ^{p.27}) compliant.
- 1024 x 768 resolution ^{p.27} and automatic full screen support for lower resolutions.
- Smoothing function incorporated for the adjustment of an enlarged image.
- DVI DMPM ^{p.27} power saving compliant, less than 3 W in power saving mode.
- Two kinds of brightness adjustment accessible through the brightness selection button on the front panel.

1-2. Package Contents

Please contact your local dealer for assistance if any of the listed items are missing or damaged.

- LCD Monitor

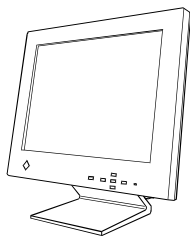

- Power Cord

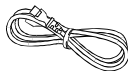

- Signal Cable (FD-C04)

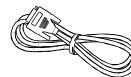

- 4 of M4 x 16 mm mounting screws



- Warranty Registration Card



- User's Manual

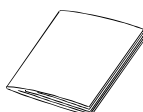

- Quick Reference



NOTE

- Please retain the packing materials for future transference.

1-3. Controls & Connectors

Front

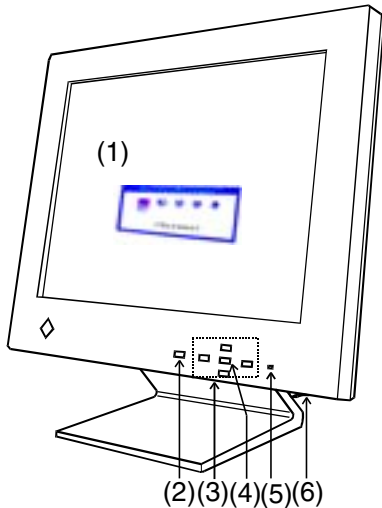

- (1) ScreenManager™
- (2) Brightness Selection Button
- (3) Control Buttons
- (4) Enter Button
- (5) Power Indicator*¹

Indicated color	Monitor's status
Green	Power -on
Yellow	Power save mode
Flashing Yellow (2 times for each)	Power save mode

- (6) Power Switch

Rear

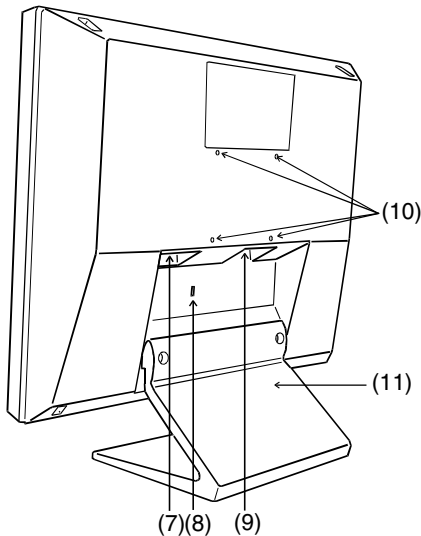

- (7) Power Connector
- (8) Security Lock Slot*²
- (9) DVI-D Input Connector
- (10) 4 Holes for Mounting an Arm-Stand*³
- (11) Stand (Detachable)*³

*¹ Regarding the power indicator for the “Off Timer”, see page 16.

*² Allows for connection of a security cable. This lock supports Kensington’s MicroSaver security system. For further information, please consult:

Kensington Technology Group 2855 Campus Drive, San Mateo, CA 94403 USA
800-650-4242, x3348

Intl: 650-572-2700, x3348 / Fax: 650-572-9675

<http://www.kensington.com>

*³ The L351 can be used with an optional arm stand by removing the stand (see page 20).

2. CABLE CONNECTION

2-1. Before Connecting

Following 4 resolutions ^{p-27)} with frequency can be displayed on this model. The lower display modes like 640 x 480 or 720 x 400 mode, automatically enlarge to the maximum display mode (1024 x 768). In this case, some lines of the characters may become fuzzy. Use “Smoothing” function to make the lines clear (see page 18).

Resolution	Frequency	Remarks
640 x 480	60 Hz	VGA
720 x 400	70 Hz	VGA Text
800 x 600	60 Hz	VESA
1024 x 768	60 Hz	VESA

2-2. Connecting the Signal Cable

NOTE

- Be sure that the power switches of both the PC and the monitor are OFF.

1. Plug the signal cable into the DVI-D connector at the rear of the monitor and the other end of the cable into the digital video connector on the PC.

After connecting, secure the connection with the screw-in fasteners.

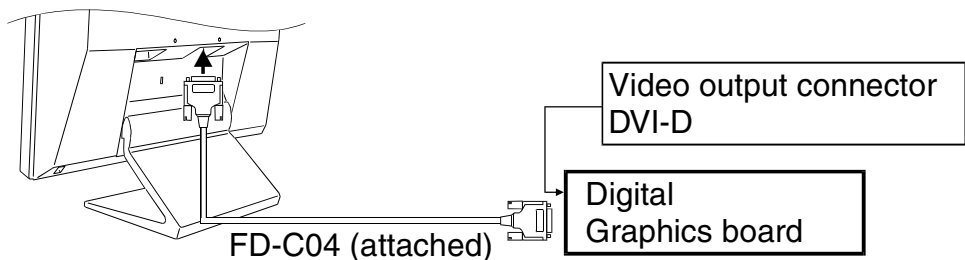

2. Plug the power cord into the power connector on the rear of the monitor. Plug the other end of the power cord into a power outlet.

 **WARNING**

- **Use the enclosed power cord. If using the power cord other than the enclosed one, follow these guidelines.**

[USA and Canada]

Use a UL LISTED/CSA LABELED or CERTIFIED power cord set meeting the following specifications:

- * Rating: min. 125 V, 10 A
- * Length: max.2.0 m * Type: SVT
- * Plug type: NEMA 5-15P, Parallel blade, Grounding type, 125 V, 10 A

[Europe]

Use a proper European standard approved power cord meeting the following specifications:

- * Rating: min. 250 V, 10 A *Length: max.2.0 m
- * Type: H05VV-F 3G 1 mm²

Use a plug type approved by the country where you reside. Failure to do so may cause fire or electric shock.

- **The equipment must be connected to a grounded main outlet.**



3. Turn on the monitor's main power and then switch on the PC's power.

When finished, turn off the PC and the monitor.

3. ScreenManager

3-1. How to use the ScreenManager

As shown on the display, the ScreenManager is used to adjust the LCD monitor. ScreenManager consists of main menus and sub menus. Adjustments are made using the Enter and Control buttons (up, down, right and left) located on the front panel.

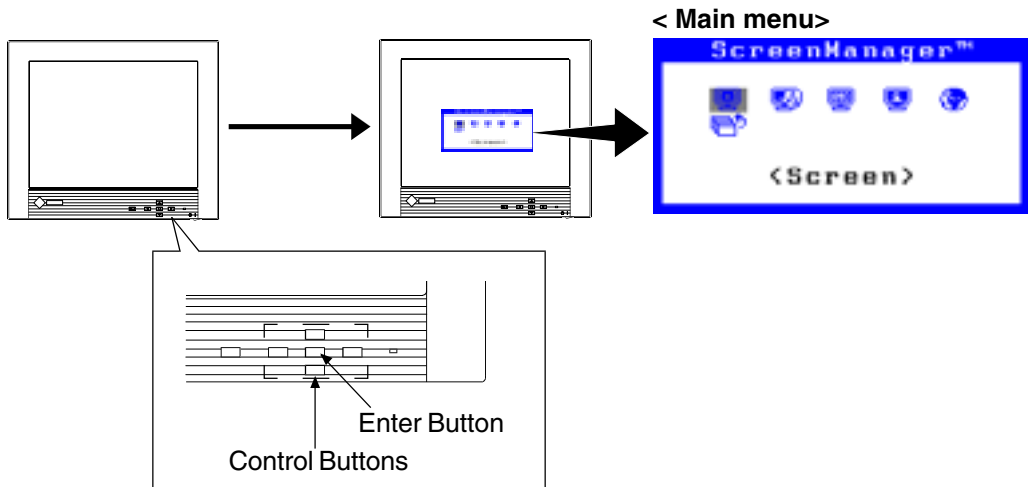

1. Entering the ScreenManager

Push the Enter button once to display the main menu of the ScreenManager.

2. Making Adjustments and Settings

- (1) Select the desired sub menu icon using the Control buttons and push the Enter button. The sub menu appears.
- (2) Use the Control buttons to select the desired setting icon and push the Enter button. The setting menu appears.
- (3) Use the Control buttons to make all required adjustments and push the Enter button to save the settings.

3. Exiting the ScreenManager

- (1) To return to the main menu, select the "Return" icon or push the down button, followed by the Enter button.
- (2) To exit the ScreenManager, select "Exit" icon and push the Enter button.

NOTE

- Double clicking the Enter button at any time also exits the ScreenManager menu.
- Leaving the ScreenManager idle for 45 seconds or more will turn the adjustment off automatically, without saving the adjustments.

3-2. ScreenManager Adjustments and Settings.

The following table shows all the ScreenManager's adjustment and setting menus.

Main menu	Sub menu	Reference
Screen	Position	4-1. Screen Adjustment (p. 17)
	Resolution	
	Smoothing	
	Brightness	
PowerManager	DVI DMPM	4-2. Power-save Setup (p.19)
Others	Off timer	Set the monitor's timer to on or off (p.16).
	Menu Position	Adjust the ScreenManager's menu position.
	Reset	Return to the factory default settings. (p. 25)
Information	Information	Review the current ScreenManager's settings.
Language	English, German, French, Spanish, Italian, Swedish and Japanese	Select the ScreenManager's language.

3-3. Useful Functions

Adjustment Lock

Use the "Adjustment Lock" function to prevent any accidental changes.

Locked function	• Adjustments and settings in the ScreenManager.
Unlocked function	• Brightness selection button • Adjustment of brightness by the up and down buttons.

- To lock
Press on the brightness selection button while switching on the power.
- To unlock
Switch off the monitor's power, then hold down the brightness selection button once again and turn the power back on.

Off Timer

The off timer function causes the monitor to automatically enter a power off state after a predetermined amount of time has lapsed. This function was created to reduce afterimage ^{p.27)} characteristics that are particular to LCD monitors when the monitor screen is left on for a long period without use.

[Procedure]

- (1) Select “Off Timer” in the ScreenManager “Others” menu.
- (2) Select “Enable” and press the right and left buttons to adjust the “On Period” (1 to 23 hours).

[Off timer system]

PC	Monitor	LED
On Period (1H~23H)	Operation	Green
Last 15 min. in "On period"	Advance Notice ^{*1}	Green Flashing
"On period" expired	"Power Off" Mode	Flashing yellow slowly

^{*1} Advance notice (LED flashing green) will be given 15 minutes before the monitor automatically enters the “Power Off” mode. To delay entering the “Power Off” mode, press any button during the advance notice period. The monitor will continue to operate for an additional 90 minutes.

Press any button to return to a normal screen.

NOTE

- The off timer function works while the PowerManager is active, but there is no advance notice before the monitor’s power is switched off.

4. ADJUSTMENT

4-1. Screen Adjustment

The monitor displays the digital input image correctly based on its pre-setting data. However, if the image position is not incorrect or larger than the actual image screen, please adjust the following adjustment items using the “Screen” menu of the ScreenManager.

NOTE

- Allow the monitor to warm up for at least 20 minutes before making any adjustments.

1. The screen position is incorrect.

→ “Position” adjustment

The correct displayed position of the monitor is decided because the number and the position of the pixels are fixed. The “Position” adjustment moves the image to the correct position.

Select “Position” and adjust the position of the upper left corner of the image by using the up, down, right and left buttons in order to align the screen.

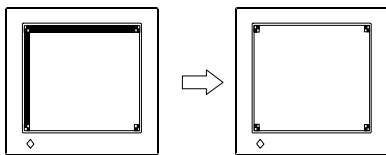

2. Screen image is smaller or larger than the actual screen images.

→ “Resolution” adjustment

Adjustment is needed when the input signal resolution and the resolution now being displayed are different.

Select “Resolution” and confirm if the resolution now being displayed is the same as the input resolution. If it is not, adjust the vertical resolution using the up and down button and adjust the horizontal resolution using the right and left buttons.

Smaller than the actual screen images.

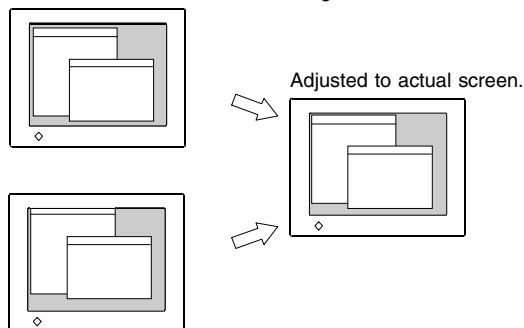

Larger than the actual screen images.

3. Smooth blurred texts.

→  Adjust the “Smoothing”

Select a suitable level from 1~5 (soft ~ sharp).

Select “Smoothing” and adjust by using the right and left buttons.

4. Set the Brightness of the screen

→  Adjust the “Brightness”

This controls the brightness of the screen. The brightness of the entire screen is controlled by changing the brightness of the backlight.

[Brightness 1 & Brightness 2]

The L351 has two memories for the preferable brightness setting (Brightness 1 & Brightness 2). The brightness selection button on the front panel can be used to select Brightness 1 or Brightness 2.

There are two ways to access the brightness function.

- 1) Select “Brightness” in the “Screen” menu.
- 2) Press the brightness selection button on the front panel.

Use the up and down control buttons for adjustment.

4-2. Power-save Setup

This monitor complies with the DVI DMPM ^{p.27}.

[Procedure]

- (1) Set the PC's power saving settings.
- (2) Select "DVI DMPM" in the "PowerManager" menu.

[Power saving system]

PC	Monitor	LED	Power consumption
On	Operation	Green	35 W
Power saving	Power saving	Yellow	Less than 3 W
Off mode	Power saving	Flashing yellow (2 times for each)	Less than 1 W

Operate the mouse or keyboard to return to a normal screen from the Power save mode of the PC.

Power on the PC to return to a normal screen from the Off mode of the PC.

NOTE

- Do your part to conserve energy, turn off the monitor when you are finished using it. Disconnecting the monitor from the power supply is recommended to save energy completely.

5. ATTACHING AN ARM STAND

The L351 can be used with an arm stand by removing the tilt stand and attaching the arm stand to the terminal.

NOTE

- ✓ Use an arm stand that satisfies the followings.
- When using the L351 with an arm stand, the arm stand must be VESA approved :
 - * Use an arm stand with a 75 mm x 75 mm hole spacing on the arm mounting pad.
 - * Use an arm stand that is able to support an object weighing 8.0 kg.
- ✓ TÜV/GS approved arm stand.
- ✓ Use an arm stand with sufficient stability (mechanical firmness) to support the weight of the monitor.
- ✓ Use an arm stand remaining that position where it is manually moved.
- ✓ Use an arm stand with the ability to tilt the monitor forward and backward.
- ✓ Use an arm stand less than or equal to 500 mm in relation to the desk surface when the arm stand is in its lowest position.
- ✓ Please connect cables after attaching an arm stand.

M4 x 16 mm

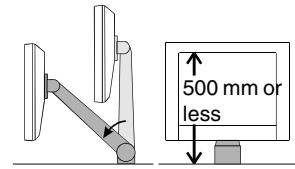
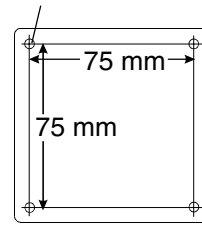

(Example)

Setup Procedure

1. Lay the L351 down as shown below. Do not scratch the panel.

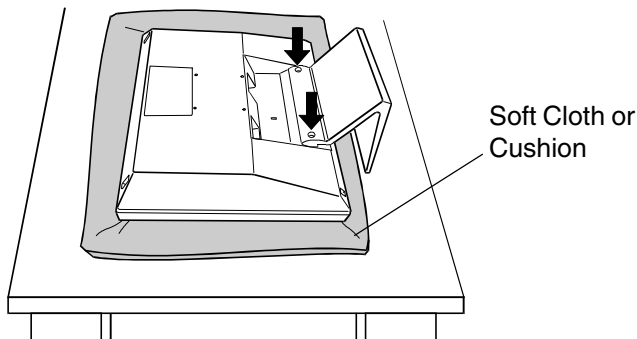

2. Remove the tilt stand by loosening the screws (2 pcs of M4 x 10 mm).

3. Attach an arm stand to the L351 securely.

WARNING

Install the unit securely when attaching to an arm stand.

When attaching an arm stand, please refer to the user's manual of the arm stand and install the unit securely with the enclosed screws. Not doing so may cause the unit to come unattached, which may result in injury or equipment damage. When the unit is dropped, please ask your dealer for advice. Do not continue using a damaged unit. Using a damaged unit may result in fire or electric shock.

When reattaching the tilt stand, please use the same screws (M4 x 10 mm) and tighten them securely.

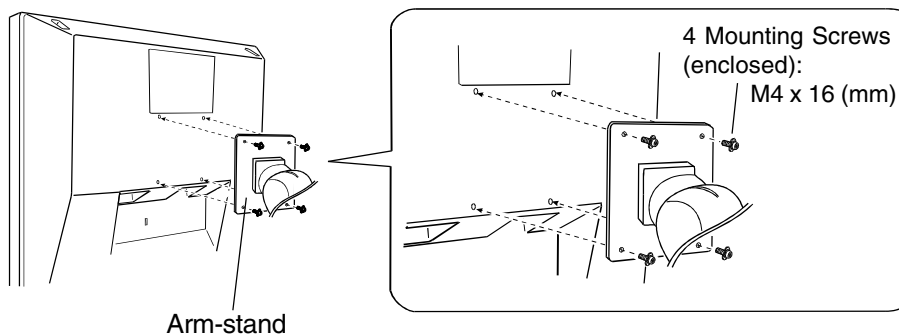

6. TROUBLESHOOTING

If a problem persists even after applying the suggested remedies, contact an EIZO dealer.

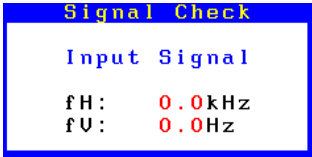
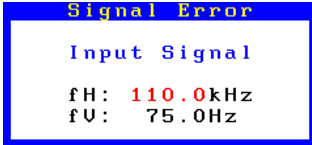
Problems	Points to check with possible solutions
<p>1. No picture</p> <ul style="list-style-type: none"> Indicator status: Off <hr/> <ul style="list-style-type: none"> Indicator status: Green Indicator status : Yellow : Flashing Yellow Indicator status: Slowly flashing Yellow 	<ul style="list-style-type: none"> <input type="checkbox"/> Check that the power cord is correctly connected. <input type="checkbox"/> If the problem persists, turn off the monitor power for a few minutes, then turn it back on and try again. <hr/> <ul style="list-style-type: none"> <input type="checkbox"/> Check the “Brightness” settings. Minimum settings will cause screen to be blank. <input type="checkbox"/> Try pressing a key on the keyboard, or clicking the mouse. (p.19) <hr/> <ul style="list-style-type: none"> <input type="checkbox"/> Try pressing any button on the front panel. (p.16)
<p>2. Following messages appear.</p>  <p>The screenshot shows a blue-bordered box with a black background. At the top, 'Signal Check' is written in yellow. Below it, 'Input Signal' is written in blue. At the bottom, 'fH: 0.0kHz' and 'fV: 0.0Hz' are written in red.</p>	<p>These messages appear when the signal is not inputted correctly, even if the monitor functions properly. Error messages shown below will remain on the screen for 40 seconds.</p> <ul style="list-style-type: none"> <input type="checkbox"/> When the image is displayed correctly after a short time, there is no problem with the monitor. (Some PC's do not output the signal soon after powering on.) <input type="checkbox"/> Check that the PC is turned ON. <input type="checkbox"/> Check that the signal cable is properly connected to the PC or graphics board.
<ul style="list-style-type: none"> Whenever an error signal message appears, the signal frequency will be displayed in red. <p>(Example)</p>  <p>The screenshot shows a blue-bordered box with a black background. At the top, 'Signal Error' is written in yellow. Below it, 'Input Signal' is written in blue. At the bottom, 'fH: 110.0kHz' and 'fV: 75.0Hz' are written in red.</p>	<ul style="list-style-type: none"> <input type="checkbox"/> Use the graphics board's utility software to change the frequency setting. (Refer to the manual of the graphics board.)

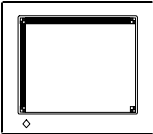
Problems	Points to check with possible solutions
<p>3. Display position is incorrect.</p> 	<ul style="list-style-type: none"> <input type="checkbox"/> Adjust the image position using the “Position”. (p.17) <input type="checkbox"/> If the problem persists, use the graphics board’s utility software to change the display position if available.
<p>4. Screen image is smaller or larger than the actual screen images.</p>	<ul style="list-style-type: none"> <input type="checkbox"/> Adjust the resolution using the “Resolution”. (p.17)
<p>5. Letters and lines appear blurred.</p>	<ul style="list-style-type: none"> <input type="checkbox"/> Adjust the blurred lines using “Smoothing”. (p.18)
<p>6. Afterimages appear.</p>	<ul style="list-style-type: none"> <input type="checkbox"/> When the screen image is changed after displaying the same image for a long period, an afterimage may appear. Use the “Off Timer” function and avoid keeping the screen on all the time. (p.16)
<p>7. The screen has defective pixels (e.g. slightly light or dark).</p>	<ul style="list-style-type: none"> <input type="checkbox"/> This is due to the characteristics of the panel itself, and not the LCD product.
<p>8. Fingerprints remain on the screen.</p>	<ul style="list-style-type: none"> <input type="checkbox"/> Leaving the screen white may solve the problem.
<p>9. The “Smoothing” function does not select.</p>	<ul style="list-style-type: none"> <input type="checkbox"/> The “Smoothing” is disable when the screen resolution is 1024 x 768.
<p>10. The Enter button does not operate.</p>	<ul style="list-style-type: none"> <input type="checkbox"/> The adjustment lock is probably on. To unlock: switch the LCD monitor off. Then, while pressing the Brightness selection button on. (p.15)

7. CLEANING

Periodic cleaning is recommended to keep the monitor looking new and to prolong its operation lifetime.

WARNING

✓ **Keep liquids away from the unit.**

Spillage into the cabinet may result in fire, electric shock, or equipment damage.

If an object or liquid falls/spills into the cabinet, unplug the monitor immediately. Have the unit checked by a qualified service engineer before using it again.



CAUTION

✓ **Unplug the unit before cleaning it.**

Cleaning the unit while it is plugged into a power outlet may result in electric shock.

✓ **Never use thinner, benzene, alcohol (ethanol, methanol, or isopropyl alcohol), abrasive cleaners, or other strong solvents, as these may cause damage to the cabinet or LCD panel.**



✓ **Periodically clean the area around the plug.**

Buildup of dust water, or oil on the plug may result in fire.

Cabinet

To remove stains, wipe the cabinet with a soft, lightly moistened cloth using a mild detergent. Do not spray wax or cleaner directly onto the cabinet.

LCD Panel

The LCD surface can be cleaned with a soft cloth, such as cotton or lens paper.

If necessary, stubborn stains can be removed by moistening part of a cloth with water to enhance its cleaning power.

8. SPECIFICATIONS

LCD Panel	38 cm (15.0 inch), TFT color LCD panel with Anti-Glare Hard Coating Viewing Angle: Horizontal: 120°, Vertical: 140° (at Contrast Ratio > 5)
Dot Pitch	0.297 mm
Scan Frequency	Horizontal: 31 kHz - 49 kHz (Automatic) Vertical: 60 Hz, (VGA Text : 70 Hz)
Dot Clock (Max.)	65 MHz
Display Colors	16 milion colors (max)
Resolution	1024 dots x 768 lines
Active Display Area	304 mm (H) x 228 mm (V) (11.9" (H) x 8.9" (V)) (Viewable image size: 380 mm (14.9"))
Power Supply	100-120/220-240 VAC±10 %, 50/60 Hz, 0.6 A/0.3 A
Power Consumption	35 W Power Saving Mode: Less than 3 W
Input Connector	DVI-D
Input Signal	TMDS (Single Link)
Signal registration	5
Plug & Play	VESA DDC 2B
Dimensions	384 mm (W) x 386.2 mm (H) x 171.4 mm (D) (15.1" (W) x 15.2" (H) x 6.7" (D))
Dimensions (without tilt stand)	384 mm (W) x 325 mm (H) x 69 mm (D) (15.1" (W) x 12.8" (H) x 2.7" (D))
Weight	5.4 kg (11.9 lbs.)
Weight (without tilt stand)	3.9 kg (8.6 lbs.)
Temperature	operating: 0 °C to 35 °C (32 °F to 95 °F) storage: -20 °C to 60 °C (-4 °F to 140 °F)
Humidity	30 % to 80 % R.H. Non-condensing
Certifications and Standards	
100-120 VAC	NRTL/C-TÜV, FCC-B, TCO'99*1, EPA ENERGY STAR® Program CE, CB, TÜV Rheinland/GS, TCO'99*1, EPA ENRTGY STAR® Program, TÜV Rheinland/ Ergonomics
220-240 VAC	

*1 Applicable to gray (standard) color version only.

Default settings

Default settings are as follows:

Brightness 1/2	100 %/30 %
Smoothing	3
PowerManager	DVI-DMPM
Off Timer	Disable
Language	English

Dimensions

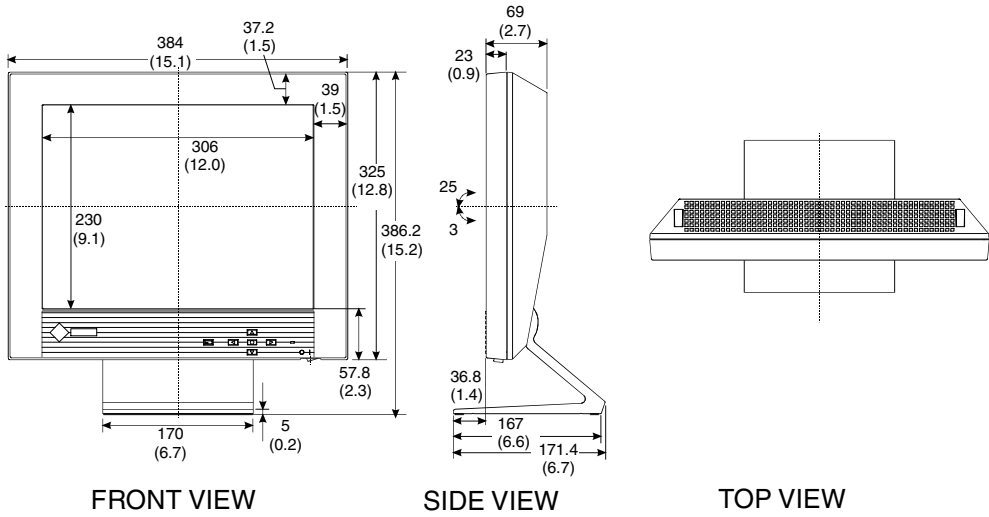

Pin Assignment

* DVI-D connector

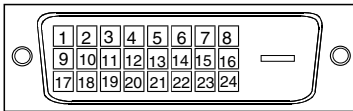

Pin No.	Signal	Pin No.	Signal	Pin No.	Signal
1	TMDS Data2-	9	TMDS Data1-	17	TMDS Data0-
2	TMDS Data2+	10	TMDS Data1+	18	TMDS Data0+
3	TMDS Data2/4 Shield	11	TMDS Data1/3 Shield	19	TMDS Data0/5 Shield
4	NC*	12	NC	20	NC
5	NC	13	NC	21	NC
6	DDC Clock (SCL)	14	+5V Power	22	TMDS Clock Shield
7	DDC Data (SDA)	15	Ground (for +5V)	23	TMDS Clock+
8	NC	16	Hot Plug Detect	24	TMDS Clock-

(*NC: No Connection)

9. GLOSSARY

Afterimage

The Afterimage is particular to LCD monitors when the monitor screen is left on for a long period without use. The “Afterimage” can be removed gradually by changing the displayed image.

DVI

(Digital Visual Interface)

A digital flat panel interface. DVI can transmit digital data from the PC directly without loss with the signal transition method “TMDS”. There are two kinds of DVI connectors. One is DVI-D connector for digital signal input only. The other is DVI-I connector for both digital and analog signal inputs.

DVI-DMPM

(DVI Digital Monitor Power Management)

The Power management system for the digital interface. The “Monitor ON” status (operation mode) and the “Active On” status (operation mode) are indispensable for the DVI-DMPM as the monitor’s power mode.

Resolution

The LCD panel consists of a fixed number of pixel elements which are illuminated to form the screen image.

The L351 display panel consists of 1024 horizontal pixels and 768 vertical pixels. At a resolution of 1024 X 768, all pixels are used and the image is displayed as a full screen.

TMDS

(Transition Minimized Differential Signaling)

A signal transition method for the digital interface.

10. INDEX

A

ADJUSTMENT ----- 17
Adjustment Lock ----- 15
Afterimage ----- 16, 23, 27
ATTACHING AN ARM STAND ----- 20

B

Brightness ----- 15, 18

C

CABLE CONNECTION ----- 12
CLEANING ----- 24
Controls & Connectors ----- 11

D

Default setting ----- 25
Dimensions ----- 26
Displaying the low resolutions ----- 12
DVI ----- 10, 27
DVI DMPM ----- 15, 19, 27

G

GLOSSARY ----- 27

H

How to use the ScreenManager ----- 14

I

Information ----- 15

L

Language ----- 15

M

Menu Position ----- 15

O

Off Timer ----- 15, 16
Others ----- 15

P

Package Contents ----- 10
Pin Assignment ----- 26
Position ----- 15, 17
Power consumption ----- 19, 25
Power Indicator ----- 11
PowerManager ----- 15, 19
Power-save Setup ----- 19
PRECAUTIONS ----- 4

R

Reset ----- 15
Resolution ----- 10, 12, 15, 17, 25, 27

S

Save ----- 14
Screen ----- 15, 17
Screen Adjustment ----- 17
ScreenManager ----- 14
ScreenManager Adjustments
and Settings ----- 15
Security Lock Slot ----- 11
Smoothing ----- 15, 18
SPECIFICATIONS ----- 25

T

TMDS ----- 10, 27
TROUBLE SHOOTING ----- 22

[Applicable to gray (standard color version only).]



Congratulations!

You have just purchased a TCO'99 approved and labelled product! Your choice has provided you with a product developed for professional use. Your purchase has also contributed to reducing the burden on the environment and also to the further development of environmentally adapted electronics products.

Why do we have environmentally labelled computers?

In many countries, environmental labelling has become an established method for encouraging the adaptation of goods and services to the environment. The main problem, as far as computers and other electronics equipment are concerned, is that environmentally harmful substances are used both in the products and during their manufacture. Since it is not so far possible to satisfactorily recycle the majority of electronics equipment, most of these potentially damaging substances sooner or later enter nature.

There are also other characteristics of a computer, such as energy consumption levels, that are important from the viewpoints of both the work (internal) and natural (external) environments. Since all methods of electricity generation have a negative effect on the environment (e.g. acidic and climate-influencing emissions, radioactive waste), it is vital to save energy. Electronics equipment in offices is often left running continuously and thereby consumes a lot of energy.

What does labelling involve?

This product meets the requirements for the TCO'99 scheme which provides for international and environmental labelling of personal computers. The labelling scheme was developed as a joint effort by the TCO (The Swedish Confederation of Professional Employees), Svenska Naturskyddsforeningen (The Swedish Society for Nature Conservation) and Statens Energimyndighet (The Swedish National Energy Administration).

Approval requirements cover a wide range of issues: environment, ergonomics, usability, emission of electric and magnetic fields, energy consumption and electrical and fire safety.

The environmental demands impose restrictions on the presence and use of heavy metals, brominated and chlorinated flame retardants, CFCs (freons) and chlorinated solvents, among other things. The product must be prepared for recycling and the manufacturer is obliged to have an environmental policy which must be adhered to in each country where the company implements its operational policy.

The energy requirements include a demand that the computer and/or display, after a certain period of inactivity, shall reduce its power consumption to a lower level in one or more stages. The length of time to reactivate the computer shall be reasonable for the user.

Labelled products must meet strict environmental demands, for example, in respect of the reduction of electric and magnetic fields, physical and visual ergonomics and good usability.

Below you will find a brief summary of the environmental requirements met by this product.

The complete environmental criteria document may be ordered from:

TCO Development

SE-114 94 Stockholm, Sweden

Fax: +46 8 782 92 07

Email (Internet): development@tco.se

Current information regarding TCO'99 approved and labelled products may also be obtained via the Internet, using the address: <http://www.tco-info.com/>

[Applicable to gray (standard color version only).]

Environmental requirements

Flame retardants

Flame retardants are present in printed circuit boards, cables, wires, casings and housings. Their purpose is to prevent, or at least to delay the spread of fire. Up to 30% of the plastic in a computer casing can consist of flame retardant substances. Most flame retardants contain bromine or chloride, and those flame retardants are chemically related to another group of environmental toxins, PCBs. Both the flame retardants containing bromine or chloride and the PCBs are suspected of giving rise to severe health effects, including reproductive damage in fish-eating birds and mammals, due to the bio-accumulative* processes. Flame retardants have been found in human blood and researchers fear that disturbances in foetus development may occur.

The relevant TCO'99 demand requires that plastic components weighing more than 25 grams must not contain flame retardants with organically bound bromine or chlorine. Flame retardants are allowed in the printed circuit boards since no substitutes are available.

Cadmium**

Cadmium is present in rechargeable batteries and in the colour-generating layers of certain computer displays. Cadmium damages the nervous system and is toxic in high doses. The relevant TCO'99 requirement states that batteries, the colour-generating layers of display screens and the electrical or electronics components must not contain any cadmium.

Mercury**

Mercury is sometimes found in batteries, relays and switches. It damages the nervous system and is toxic in high doses. The relevant TCO'99 requirement states that batteries may not contain any mercury. It also demands that mercury is not present in any of the electrical or electronics components associated with the labelled unit.

CFCs (freons)

The relevant TCO'99 requirement states that neither CFCs nor HCFCs may be used during the manufacture and assembly of the product. CFCs (freons) are sometimes used for washing printed circuit boards. CFCs break down ozone and thereby damage the ozone layer in the stratosphere, causing increased reception on earth of ultraviolet light with e.g. increased risks of skin cancer (malignant melanoma) as a consequence.

Lead**

Lead can be found in picture tubes, display screens, solders and capacitors. Lead damages the nervous system and in higher doses, causes lead poisoning. The relevant TCO'99 requirement permits the inclusion of lead since no replacement has yet been developed.

* Bio-accumulative is defined as substances which accumulate within living organisms.

** Lead, Cadmium and Mercury are heavy metals which are Bio-accumulative.

For U.S.A, Canada, etc. (rated 100-120 Vac) Only

FCC Declaration of Conformity

We, the Responsible Party EIZO NANAOTECHNOLOGIES INC.
5710 Warland Drive, Cypress, CA 90630
Phone: (562) 431-5011

declare that the product Trade name: EIZO
Model: FlexScan L351

is in conformity with Part 15 of the FCC Rules. Operation of this product is subject to the following two conditions: (1) this device may not cause harmful interference, and (2) this device must accept any interference received, including interference that may cause undesired operation.

This equipment has been tested and found to comply with the limits for a Class B digital device, pursuant to Part 15 of the FCC Rules. These limits are designed to provide reasonable protection against harmful interference in a residential installation. This equipment generates, uses, and can radiate radio frequency energy and, if not installed and used in accordance with the instructions, may cause harmful interference to radio communications. However, there is no guarantee that interference will not occur in a particular installation. If this equipment does cause harmful interference to radio or television reception, which can be determined by turning the equipment off and on, the user is encouraged to try to correct the interference by one or more of the following measures.

- *Reorient or relocate the receiving antenna.
- *Increase the separation between the equipment and receiver.
- *Connect the equipment into an outlet on a circuit different from that to which the receiver is connected.
- *Consult the dealer or an experienced radio/TV technician for help.

Changes or modifications not expressly approved by the party responsible for compliance could void the user's authority to operate the equipment.

Note

Use the attached specified cable below or EIZO signal cable with this monitor so as to keep interference within the limits of a Class B digital device.

- AC Cord
- Shielded Signal Cable (DVI-D cable, the enclosed signal cable)

Canadian Notice

This Class B digital apparatus complies with Canadian ICES-003.

Cet appareil numérique de la classe B est conforme à la norme NMB-003 du Canada.

Hinweis zur Ergonomie :

Dieser Monitor erfüllt die Anforderungen an die Ergonomie nach EK1/59-98, EK1/60-98 mit dem Videosignal, 1024 Punkte x 768 Zeilen, Digital Eingang und mindestens 60,0 Hz Bildwiederholfrequenz, non interlaced. Weiterhin wird aus ergonomischen Gründen empfohlen, die Grundfarbe Blau nicht auf dunklem Untergrund zu verwenden (schlechte Erkennbarkeit, Augenbelastung bei zu geringem Zeichenkontrast.)

Recycle Auskunft

Die Rücknahme dieses Produktes nach Nutzungsende übernimmt EIZO in Deutschland zusammen mit dem Partner von Roll MBB Recycling GmbH. Dort werden die Geräte in ihre Bestandteile zerlegt, die dann der Wiederverwertung zugeführt werden. Um einen Abholtermin zu vereinbaren und die aktuellen Kosten zu erfahren, benutzen Sie bitte folgende Rufnummer: 02153-73 35 00. Weitere Informationen finden Sie auch unter der Internet-Adresse: www.eizo.de.