

Instructions for Use

■ User's Manual

RadiForce® MX240W

Color LCD Monitor

Important





Please read this User's Manual and Setup Manual (separate volume) carefully to familiarize yourself with safe and effective usage.

-
- Please refer to the Setup Manual for basic information ranging from connection of the monitor to a PC to using the monitor.
 - The latest User's Manual is available for download from our web site:
<http://www.eizo.com>
-



SAFETY SYMBOLS

This manual uses the safety symbols below. They denote critical information. Please read them carefully.

	<p>WARNING Failure to abide by the information in a WARNING may result in serious injury and can be life threatening.</p>
	<p>CAUTION Failure to abide by the information in a CAUTION may result in moderate injury and/or property or product damage.</p>
	<p>Indicates a prohibited action.</p>
	<p>Indicates to ground for safety.</p>

No part of this manual may be reproduced, stored in a retrieval system, or transmitted, in any form or by any means, electronic, mechanical, or otherwise, without the prior written permission of EIZO Corporation. EIZO Corporation is under no obligation to hold any submitted material or information confidential unless prior arrangements are made pursuant to EIZO Corporation's receipt of said information. Although every effort has been made to ensure that this manual provides up-to-date information, please note that EIZO monitor specifications are subject to change without notice.

Apple, Mac, Macintosh, iMac, eMac, Mac OS, MacBook, PowerBook, ColorSync, QuickTime, and iBook are registered trademarks of Apple Inc.

Windows, Windows Vista, Windows Media, SQL Server, and Xbox 360 are registered trademarks of Microsoft Corporation in the United States and other countries.

VESA is a registered trademark or a trademark of the Video Electronics Standards Association in the United States and other countries.

EIZO, the EIZO Logo, ColorEdge, DuraVision, FlexScan, FORIS, RadiForce, RadiCS, RadiNET, Raptor, and ScreenManager are registered trademarks of EIZO Corporation in Japan and other countries.

All other company and product names are trademarks or registered trademarks of their respective owners.

This product has been adjusted specifically for use in the region to which it was originally shipped. If operated outside this region, the product may not perform as stated in the specifications.

- It shall be assured that the final system is in compliance to IEC60601-1-1 requirement.
- Power supplied equipment can emit electromagnetic waves, that could influence, limit or result in malfunction of the monitor. Install the equipment in a controlled environment, where such effects are avoided.
- This is a monitor intended for use in a medical imaging system. It does not support the display of mammography images for diagnosis.

PRECAUTIONS



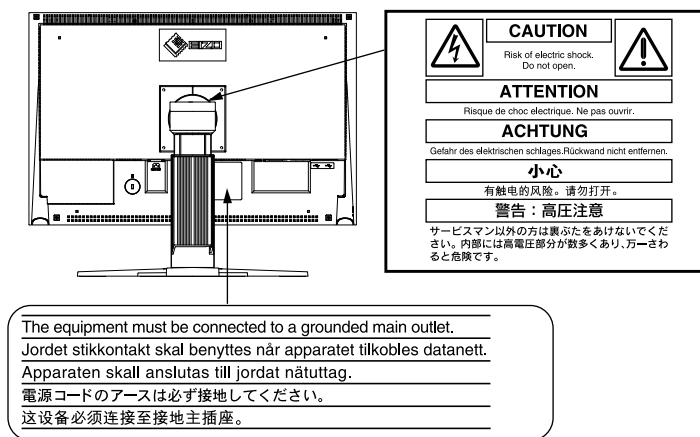

IMPORTANT!

- This product has been adjusted specifically for use in the region to which it was originally shipped. If operated outside the region to which it was originally shipped, the product may not perform as stated in the specifications.
- To ensure personal safety and proper maintenance, please read this section and the caution statements on the unit (refer to the figure below).

[Location of the Caution Statements]



[Symbol on the Unit]

Symbol	This symbol indicates
	Power Button Press to turn the monitor's power on or off.
	Alternating current
	Alerting electrical hazard
	Caution Refer to SAFETY SYMBOLS section in this manual.

WARNING

If the unit begins to emit smoke, smells like something is burning, or makes strange noises, disconnect all power connections immediately and contact your dealer for advice.

Attempting to use a malfunctioning unit may result in fire, electric shock, or equipment damage.

⚠ WARNING

Do not open the cabinet or modify the unit.

Opening the cabinet or modifying the unit may result in fire, electric shock, or burn.



Refer all servicing to qualified service personnel.

Do not attempt to service this product yourself as opening or removing covers may result in fire, electric shock, or equipment damage.

Keep small objects or liquids away from the unit.

Small objects accidentally falling through the ventilation slots into the cabinet or spillage into the cabinet may result in fire, electric shock, or equipment damage. If an object or liquid falls/spills into the cabinet, unplug the unit immediately. Have the unit checked by a qualified service engineer before using it again.

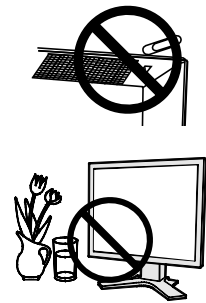

Place the unit at the strong and stable place.

A unit placed on an inadequate surface may fall and result in injury or equipment damage.

If the unit falls, disconnect the power immediately and ask your dealer for advice. Do not continue using a damaged unit. Using a damaged unit may result in fire or electric shock.

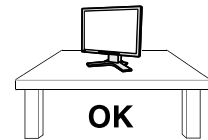

Use the unit in an appropriate location.

Not doing so may result in fire, electric shock, or equipment damage.

- Do not place outdoors.
- Do not place in the transportation system (ship, aircraft, trains, automobiles, etc.)
- Do not place in a dusty or humid environment.
- Do not place in a location where water is splashed on the screen (bathroom, kitchen, etc.).
- Do not place in a location where the steam comes directly on the screen.
- Do not place near heat generating devices or a humidifier.
- Do not place in a location where the product is subject to direct sunlight.
- Do not place in an inflammable gas environment.

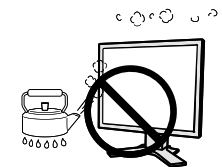

To avoid danger of suffocation, keep the plastic packing bags away from babies and children.

Use the enclosed power cord and connect to the standard power outlet of your country.

Be sure to remain within the rated voltage of the power cord. Not doing so may result in fire or electric shock.

Power supply: 100-120/200-240 Vac, 50/60 Hz

To disconnect the power cord, grasp the plug firmly and pull.

Tugging on the cord may damage and result in fire or electric shock.



WARNING

The equipment must be connected to a grounded main outlet.
Not doing so may cause in fire or electric shock.



Use the correct voltage.

- The unit is designed for use with a specific voltage only. Connection to another voltage than specified in this User's Manual may cause fire, electric shock, or equipment damage.

Power supply: 100-120/200-240 Vac, 50/60 Hz

- Do not overload your power circuit, as this may result in fire or electric shock.

Handle the power cord with care.

- Do not place the cord underneath the unit or other heavy objects.
- Do not pull on or tie the cord.

If the power cord becomes damaged, stop using it. Use of a damaged cord may result in fire or electric shock.



For the electrical safety, do not connect or disconnect the power cord in the presence of patients.

Never touch the plug and power cord if it begins to thunder.

Touching them may result in electric shock.



When attaching an arm stand, please refer to the user's manual of the arm stand and install the unit securely.

Not doing so may cause the unit to become unattached, which may result in injury or equipment damage. Before installation, make sure that desks, walls, and others an arm stand is fixed on have adequate mechanical strength.

When the unit is dropped, please ask your dealer for advice.

Do not continue using a damaged unit. Using a damaged unit may result in fire or electric shock. When reattaching the tilt stand, please use the same screws and tighten them securely.

Do not touch a damaged LCD panel directly with bare hands.

The liquid crystal which leaks from the panel is poisonous if it enters the eyes or mouth.

If any part of the skin or body comes in direct contact with the panel, please wash thoroughly. If some physical symptoms result, please consult your doctor.



Fluorescent backlight lamps contain mercury (the products that have LED backlight lamps contain no mercury), dispose according to local, state or federal laws.

Exposure to elemental mercury can result in effects on the nervous system, including tremor, memory loss, and headache.

CAUTION

Handle with care when carrying the unit.

Disconnect the power cord and cables when moving the unit. Moving the unit with the cord attached is dangerous. It may result in injury.

⚠ CAUTION

When handling the unit, grip the bottom of the unit firmly with both hands ensuring the panel faces outward before lifting.

Dropping the unit may result in injury or equipment damage.

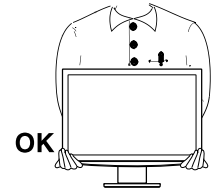

Do not block the ventilation slots on the cabinet.

- Do not place any objects on the ventilation slots.
- Do not install the unit in a closed space.
- Do not use the unit laid down or upside down.

Blocking the ventilation slots prevents proper airflow and may result in fire, electric shock, or equipment damage.



Do not touch the plug with wet hands.

Doing so may result in electrical shock.



Use an easily accessible power outlet.

This will ensure that you can disconnect the power quickly in case of a problem.

Periodically clean the area around the plug.

Dust, water, or oil on the plug may result in fire.

Unplug the unit before cleaning it.

Cleaning the unit while it is plugged into a power outlet may result in electric shock.

If you plan to leave the unit unused for an extended period, disconnect the power cord from the wall socket after turning off the power switch for the safety and the power conservation.

Notice for this monitor

This product is suited to clinical review. It does not support the display of mammography images for diagnosis.

This product has been adjusted specifically for use in the region to which it was originally shipped. If the product is used outside the region, it may not operate as specified in the specifications.

This product may not be covered by warranty for uses other than those described in this manual.

The specifications noted in this manual are only applicable when the following are used:

- Power cords provided with the product
 - Signal cables specified by us
-

Only use optional products manufactured or specified by us with this product.

As it takes about 30 minutes for the performance of electrical parts to stabilize, adjust the monitor 30 minutes or more after the monitor power has been turned on.

Monitors should be set to a lower brightness to reduce changes in luminosity caused by long-term use and maintain a stable display.

When the screen image is changed after displaying the same image for extended periods of time, an afterimage may appear. Use the screen saver or power save function to avoid displaying the same image for extended periods of time.

Periodic cleaning is recommended to keep the monitor looking new and to prolong its operation lifetime. (Refer to "[Cleaning](#)" on the next page.)

The screen may have defective pixels or a small number of light dots on the screen. This is due to the characteristics of the panel itself, and is not a malfunction of the product.

The backlight of the LCD panel has a fixed lifetime. When the screen becomes dark or begins to flicker, please contact your dealer.

Do not press on the panel or edge of the frame strongly, as this may result in display malfunctions, such as interference patterns, etc. If pressure is continually applied to the panel, it may deteriorate or damage your panel. (If the pressure marks remain on the panel, leave the monitor with a black or white screen. The symptom may disappear.)

Do not scratch or press on the panel with any sharp objects, as this may result in damage to the panel. Do not attempt to brush with tissues as this may scratch the panel.

When the monitor is cold and brought into a room or the room temperature goes up quickly, dew condensation may occur on the interior and exterior surfaces of the monitor. In that case, do not turn the monitor on. Instead wait until the dew condensation disappears, otherwise it may cause some damage to the monitor.

Cleaning

Attention

- Chemicals such as alcohol and antiseptic solution may cause gloss variation, tarnishing, and fading of the cabinet or panel, and also quality deterioration of the image.
 - Never use any thinner, benzene, wax, and abrasive cleaner, which may damage the cabinet or panel.
-

Note

- The optional ScreenCleaner is recommended for cleaning the cabinet and panel surface.
-

If necessary, the stains on the cabinet and panel surface can be removed by moistening part of a soft cloth with water.

To use the monitor comfortably

- An excessively dark or bright screen may affect your eyes. Adjust the brightness of the monitor according to the environmental conditions.
- Staring at the monitor for a long time tires your eyes. Take a 10-minute rest every hour.

Table of Contents

Cover	1	3-10. Setting the orientation of the Adjustment menu	27
PRECAUTIONS	3	3-11. EIZO Logo Appearing Function	27
Notice for this monitor	7	4.Troubleshooting	28
Cleaning	8	5. Reference	31
To use the monitor comfortably.....	8	5-1. Attaching an arm	31
Table of Contents	9	5-2. Specifications	32
1. Introduction.....	10	Default settings	33
1-1. Features	10	CAL Switch Mode : The default display mode setting is DICOM-CL mode.	33
1-2. Buttons and Indicators	11	Others	33
1-3. Utility Disk.....	12	Dimensions	33
2. Installation.....	13	Optional	33
2-1. Connecting Two PCs to the Monitor.....	13	Pin Assignment	34
2-2. Making Use of USB (Universal Serial Bus).....	14	5-3. Glossary	35
3. Screen Adjustment and Settings	15	6. APPENDIX/ANHANG/ANNEXE	37
3-1. Basic Operation and Functions	15	FCC Declaration of Conformity	39
Functions	16	EMC Information.....	40
3-2. Screen Adjustment.....	17		
Analog Input	17		
3-3. Color Adjustment	20		
Simple adjustment [CAL Switch mode].....	20		
Advanced Adjustments[Adjustment menu].....	21		
3-4. Power-save Setup	23		
Analog Input	23		
Digital Input.....	23		
3-5. Off Timer	24		
3-6. Locking the settings	24		
3-7. Power Indicator Setting	25		
3-8. Automatic brightness adjustment	25		
3-9. Displaying Lower Resolutions	26		

1. Introduction

Thank you very much for choosing an EIZO Color Monitor.

1-1. Features

- 24" wide format LCD
- Applicable to HDCP
- Dual inputs compliant (DVI-I x 2)
- DVI Digital input (TMDS) compliant
- [Horizontal scanning frequency]
Analog: 24 - 94 kHz
Digital: 31 - 76 kHz
- [Vertical scanning frequency]
Analog: 49 - 86 Hz (1600 x 1200: 49 - 76 Hz / 1920 x 1200: 49 - 61 Hz)
Digital: 59 - 61 Hz (VGA text: 69 - 71 Hz)
- [Resolution] 1920 dots x 1200 lines
- Frame Synchronous mode supported (59 - 61 Hz)
- DICOM mode (CAL Switch function)
- CAL Switch function for selecting an optimal calibration mode
- Portrait/Landscape display available (rotate 90 degrees clockwise)
- The quality control software "RadiCS LE" (for Windows) used to calibrate the monitor is included(refer to the EIZO LCD Utility Disk).
- The utility software "ScreenManager Pro for Medical" (for Windows) to control the monitor from a PC with mouse/keyboard is included (refer to the EIZO LCD Utility Disk).
- Smoothing function incorporated for the adjustment of an enlarged image
- Height adjustable stand
- BrightRegulator function incorporate

Tips

- This monitor supports the Portrait/Landscape display. This function allows you to change the orientation of the Adjustment menu when using the monitor screen in vertical display position. (Refer to "[3-10. Setting the Orientation of the Adjustment Menu](#)" on [page 27](#).)
 - For using the monitor with "Portrait" position, the graphics board supporting portrait display is required. When using the monitor with "Portrait" position, the setting needs to be changed depending on the graphics board used in your PC. Refer to the manual of the graphics board for details.
-

1-2. Buttons and Indicators

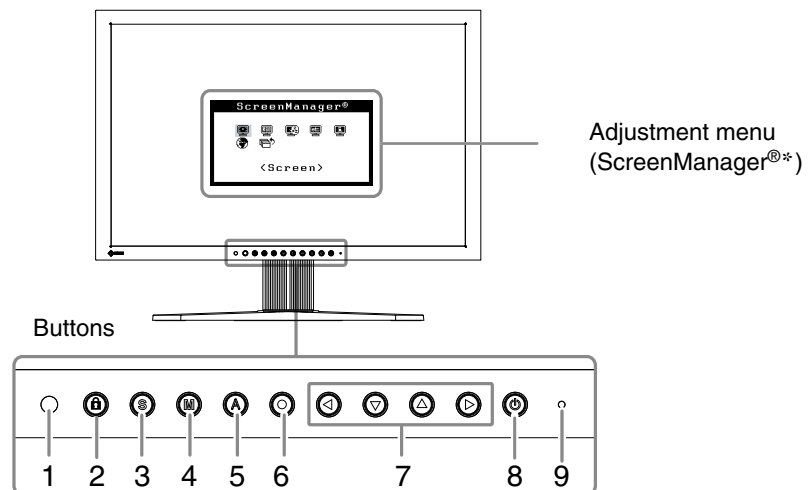

1. Sensor (BrightRegulator)
2. Adjustment Lock button
3. Input Signal Selection button
4. Mode button
5. Auto Adjustment button
6. Enter button
7. Control buttons (Left, Down, Up, Right)
8. Power button
9. Power indicator

Indicator status	Operation status
Blue	The screen is displayed
Orange	Power saving
Off	Power off

*ScreenManager® is an EIZO's nickname of the Adjustment menu.

1-3. Utility Disk

An "EIZO LCD Utility Disk" (CD-ROM) is supplied with the monitor. The following table shows the disk contents and the overview of the application software programs.

Disk contents and software overview

The disk includes application software programs for adjustment, and User's Manual. Refer to "Readme.txt" file on the disk for software startup procedures or file access procedures.

Item	Overview
A "Readme.txt" file	
RadiCS LE	RadiCS LE is quality control software used to calibrate the monitor and manage the calibration history. (A PC must be connected to the monitor with the supplied USB cable.) Refer to the description later.
ScreenManager Pro for Medical	A utility software program to control monitor adjustments from a PC using its mouse and keyboard. (A PC must be connected to the monitor with the supplied USB cable.) Refer to the description later.
User's Manual (PDF file)	

To RadiCS LE or ScreenManager Pro for Medical

Refer to the corresponding User's Manual on the CD-ROM disk in order to install and use the software. When using this software, you will need to connect a PC to the monitor with the supplied USB cable. For more information refer to the "[2-2. Making Use of USB \(Universal Serial Bus\)](#)" ([page 14](#)).

2. Installation

2-1. Connecting Two PCs to the Monitor

Two PCs can be connected to the monitor through the DVI-I connector on the back of the monitor.

Connection examples

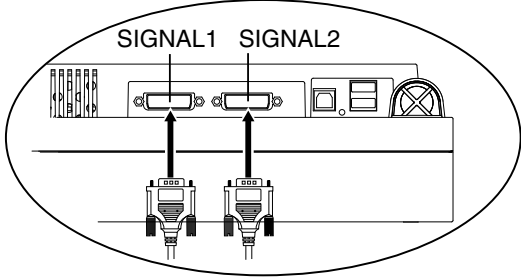

PC 1			PC 2			
(Ex.1)	Digital	DVI	Signal Cable (FD-C39 enclosed)	Signal Cable (FD-C16 enclosed)	D-Sub mini 15 pin	Analog
(Ex.2)	Analog	D-Sub mini 15 pin	Signal Cable (FD-C16 enclosed)	Signal Cable (FD-C16 optional)	D-Sub mini 15 pin	Analog

Selecting input signal

Switch the input signal with **Ⓢ**. Input signal switches each time **Ⓢ** is pressed. When the signal is switched, the active signal type (Signal 1 or 2/ Analog or Digital) appears at the top right corner of the screen for two seconds.

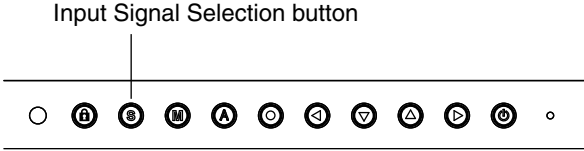

To set auto-switching of input signals [Input Signal]

The monitor recognizes the connector through which PC signals are input. When either PC is turned off or enters the power-saving mode, the monitor automatically displays signals of another PC.

Priority setting	Function
Auto	When either PC is turned off or enters the power-saving mode, the monitor automatically displays signals of another PC.
Manual	The monitor does not detect the PC's signals automatically. Select an active input signal with Ⓢ .

[Input signal setting]

1. Choose <Others> from the Adjustment menu, and press **Ⓞ**.
2. Choose <Input Signal> from the <Others> menu, and press **Ⓞ**.
The <Input Signal> menu appears.
3. Select "Auto" or "Manual" with **Ⓢ** or **Ⓡ**, and press **Ⓞ**.
The Input Priority setting is completed.

2-2. Making Use of USB (Universal Serial Bus)

This monitor provides a hub which supports the USB standard. When connecting to a USB compliant PC or another hub, the monitor functions as a hub to which the USB compliant peripherals can be easily connected.

Required system environment

- PC equipped with USB ports or another USB hub connected to the USB compliant PC
- Windows 2000/XP/Vista/7/8 // Mac OS 9.2.2/Mac OS X 10.2 or later
- USB Cable (MD-C93, enclosed)

NOTE

- The USB hub function may not work properly depending on the PC or peripherals. Please consult the manufacturer of each device about the USB support.
 - Using the USB Rev. 2.0 compatible PC or peripherals is recommended.
 - If the monitor is in the power saving mode, or if the monitor is connected to the power outlet with the monitor turned off, all the devices connected to the USB ports (upstream and downstream) work. Therefore, power consumption of the monitor varies with connected devices even in the power saving mode.
 - The followings are procedures for the Windows 2000/XP/Vista/7/8 and Mac OS.
-

Connecting to the USB HUB

- 1** Connect the monitor to the PC with the signal cable first, then turn on the PC.
- 2** Connect the upstream port of the monitor to the downstream port of the USB compliant PC or another hub by using the USB cable.
After connecting the USB cable, the USB function can be set up automatically.
- 3** After setting up, the monitor's USB hub is available for connecting USB compliant peripherals to the downstream ports of the monitor.

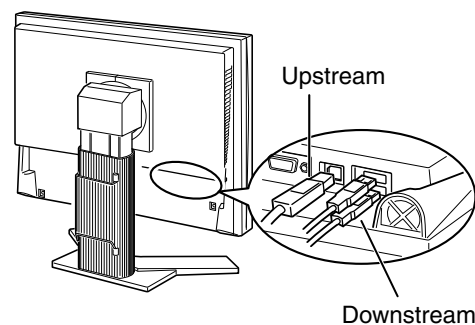

3. Screen Adjustment and Settings

3-1. Basic Operation and Functions

Adjustment menu allows you to adjust screen performance through the main menu and select a CAL Switch mode easily.

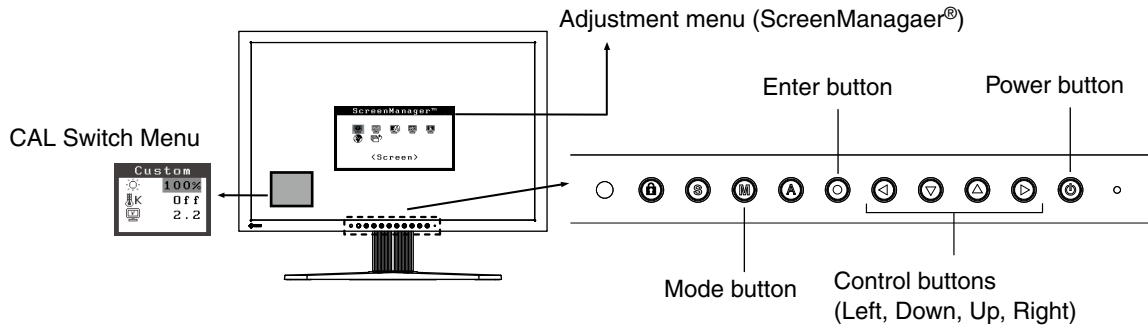















NOTE

- The Adjustment menu and the CAL Switch mode name cannot be displayed at the same time.





1 Entering the Adjustment menu

Press  once to display the main menu of the Adjustment menu.

2 Making Adjustments and Settings

1. Select the desired sub menu icon using     and press . The sub menu appears.
2. Use     to select the desired setting icon and press . The setting menu appears.
3. Use     to make all required adjustments and press  save the settings.

3 Exiting the Adjustment menu.

1. To return to the main menu, select the <Return> icon or press  twice, followed by .
2. To exit the Adjustment menu, select <Exit> icon or press  twice, followed by .

Tips

- Double clicking  at any time also exits the Adjustment menu.

Functions

The following table shows all the Adjustmet menu's adjustment and setting menus. "*" indicates adjustments of analog input only and "***" indicates digital input only.

Main menu	Sub menu		Reference	
Screen	Clock	*	3-2. Screen Adjustment	
	Phase	*		
	Position	*		
	Resolution	*		
	Range Adjustment	*		
	Smoothing			
	Signal Filter	*		
Color(Custom)* ¹	Brightness		3-3. Color Adjustment	
	Temperature			
	Gamma			
	Saturation			
	Hue			
	Gain			
	6 Colors			
	Reset			
PowerManager	DVI DMPM	**	3-4. Power-save Setup	
	VESA DPMS	*		
	OFF			
Others	Screen Size		3-9. Displaying Lower Resolutions	
	Border Intensity			
	Input Signal		Set the input signal selection of automatic or manual.	
	Off Timer		Set the monitor's Off Timer to on or off.	
	Menu Settings	Menu Size		Change the size of the menu.
		Menu Position		Adjust the menu position.
		Menu Off Timer		Set the menu displaying time.
		Translucent		Set the transparency of the background.
		Orientation		Set the orientation of the Adjustment menu.
	BrightRegulator		Set automatic brightness adjustment.	
	Power Indicator		Make non-light for blue lighting when the screen is displayed. (Power Indicator Setting.)	
Reset		Return to the factory Default settings.		
Information	Information		Review the Adjustment menu's settings, model name, serial number and usage time.* ²	
Language	English, German, French, Spanish, Italian, Swedish, Chinese(Simplified), Chinese(Traditional) and Japanese		Select the Adjustment menu's language.	

*¹ The adjustable functions on the <Color> menu depend on the selected CAL Switch mode. The above table shows the sub menus when the "Custom" mode is selected (See "3-3. Color Adjustment").

*² Due to the inspection on the factory, the usage time may not "0 hour" at shipping.

3-2. Screen Adjustment

NOTE

- Allow the LCD monitor to stabilize for at least 30 minutes before making image adjustments.

The monitor displays the digital input image correctly based on its pre-setting data.

Analog Input

Screen adjustments for the LCD monitor should be used in suppressing screen flickering and also for adjusting the screen to its proper position. There is only one correct position for each display mode. It is also recommended to use the Adjustment menu function when first installing the display or whenever changing the system.

Adjustment Procedure

1 Press **A** on the control panel.

The message "Your setting will be lost if you press again now." appears and remains on the screen for 5 seconds. While the message is on the screen, press the Auto Adjustment button again to automatically adjust the clock, phase, screen position and resolution. If you do not wish to do adjust the screen, do not press **A** again.

NOTE

- The Auto adjustment function is intended for use on the Macintosh and on AT-compatible PC running Windows. It may not work properly in either of the following cases. When running an AT-compatible PC on MS-DOS (Not windows). The background color for the "wall paper" or "desktop" pattern is set to black.
- It cannot work correctly using with some graphics cards.

If the appropriate screen cannot be made by using **A**, adjust the screen through the following procedures. If the appropriate screen can be made, proceed to [5. Range Adjustment](#).

2 Prepare the display pattern for the analog display adjustment.

Download the "Screen adjustment pattern files" from our site: <http://www.eizo.com>.

Tips

- For details and instructions on opening the "Screen adjustment pattern files", refer to the "Readme.txt" file.

3 Perform the auto size adjustment again with the analog screen adjustment pattern displayed.

(1) Display Pattern 1 of the screen adjustment pattern files in full screen on the monitor.

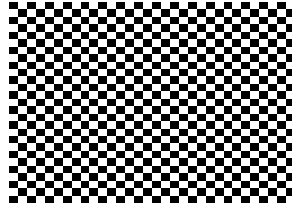

(2) From the <Screen> menu on the Adjustment menu, select <Auto Adjustment>.



(3) Select "Execute".

The Auto Adjustment function begins (showing a running status icon) to adjust flickering, screen position, and screen size automatically.

4 Adjust by using <Screen> menu in the Adjustment menu.

(1) Vertical bars appear on the screen

→  Use the <Clock> adjustment.

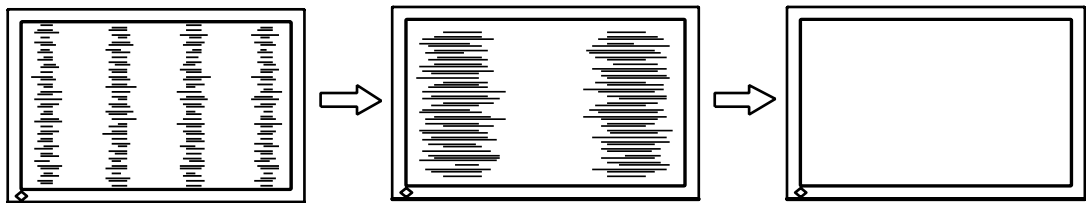

Select the <Clock> and eliminate the vertical bars by using  and  of the Control buttons.

Do not continuously press the Control buttons, as the adjustment value will change quickly and make it difficult to locate the most suitable adjustment point. If the horizontal flickering, blur or bars appear, proceed to <Phase> adjustment as follows.



(2) Horizontal flickering, blurring or bars appear on the screen.

→  Use the <Phase> adjustment.

Select the <Phase> and eliminate the horizontal flickering, blurring or bars by using  and  buttons.

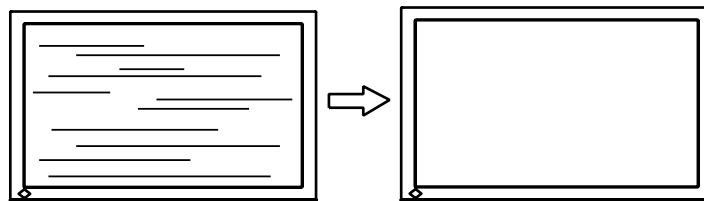





NOTE

- Horizontal bars may not completely disappear from the screen depending on the PC.

(3)The screen position is incorrect.

→  Use the <Position> adjustment.

The correct displayed position of the monitor is decided because the number and the position of the pixels are fixed. The <Position> adjustment moves the image to the correct position.



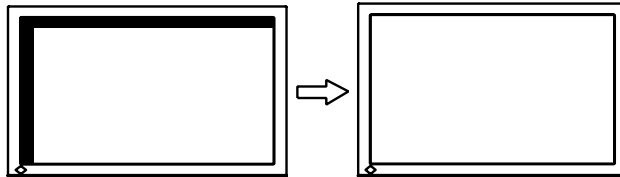

Select <Position> and adjust the position by using , ,  and . If vertical bars of distortion appear after finishing the <Position> adjustment, return to <Clock> adjustment and repeat the previously explained adjustment procedure. ("Clock" => "Phase" => "Position")



(4)Screen image is smaller or larger than the actual screen images.

→  Use the <Resolution> adjustment.

Adjustment is needed when the input signal resolution and the resolution now being displayed are different.

Select <Resolution> and confirm if the resolution now being displayed is the same as the input resolution. If it is not, adjust the vertical resolution using  and  and adjust the horizontal resolution using  and .

Smaller than the actual screen images.

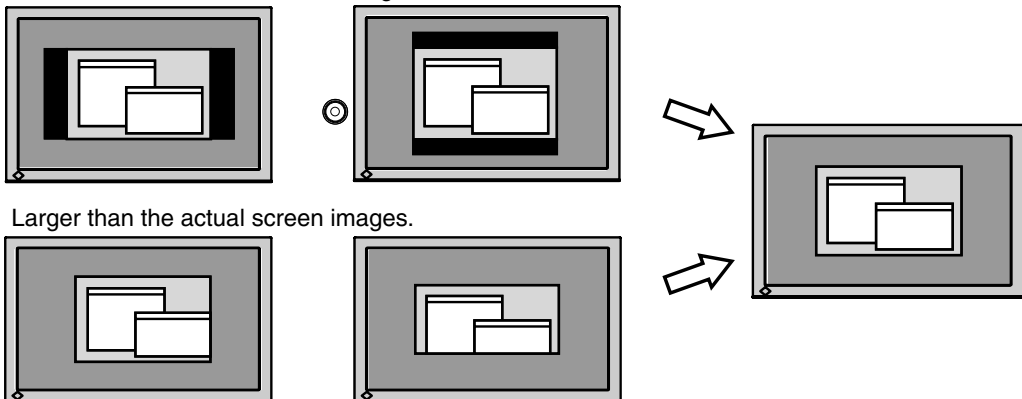

Larger than the actual screen images.

5 Adjust the output signal range (Dynamic Range) of the signal.

→  Use the <Range Adjustment> of <Screen> menu.

This controls the level of output signal range to display the whole color gradation (256 colors).

[Procedure]

(1)Display Pattern 2 of the screen adjustment pattern files in full screen on the monitor.

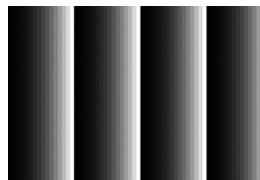

(2)Choose <Range Adjustment> from the <Screen> menu, and press .

(3)Select "Execute".

Color gradation is adjusted automatically.

(4)Close the Pattern 2.

3-3. Color Adjustment

Simple adjustment [CAL Switch mode]

This function allows you to select the best display mode for monitor brightness, etc.

To select CAL Switch mode

Directly pressing **M** allows you to select the best suited mode for screen display from 4 CAL Switch modes; DICOM-CL, Text, Custom and CAL. Color settings each mode can be adjusted by using the <Color> menu of the Adjustment menu.

Press **⏻** to exit the menu.

->DICOM-CL -> Text -> Custom -> CAL

Tips

- The Adjustment menu and the CAL Switch mode name cannot be displayed at the same time.

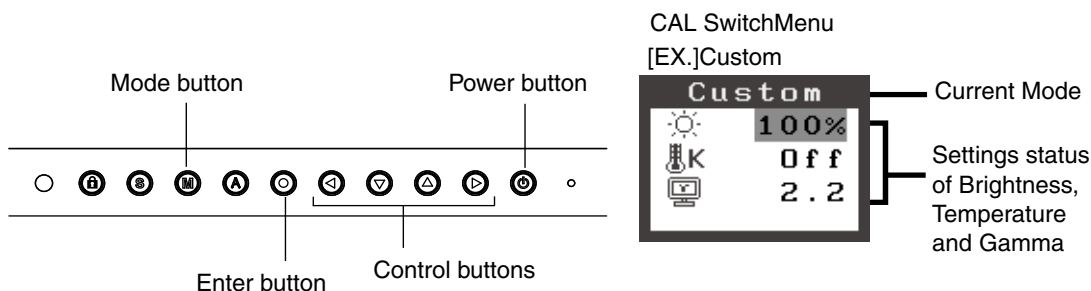

CAL Switch Mode

Selectable CAL Switch modes are as follows.

Mode	Purpose
DICOM-CL	Available for setting tailored to X-ray film color (clear base).
Text	Suitable for displaying texts for word processing or spreadsheets.
Custom	Available for making desired setting.
CAL	Used for monitor calibration.

Color Adjustment of the Mode Settings

<Brightness>, <Temperature> and <Gamma> settings can be adjusted on the CAL Switch menu. Select the desired function icon with **⏴**/**⏵** and adjust with **⏪**/**⏩** Control buttons. (Setting(s) of <Temperature> and/or <Gamma> is defined as standard default in some modes.

NOTE

- "CAL" mode can be adjusted only by Calibration Software.

Advanced Adjustments[Adjustment menu]









Color settings of each CAL Switch mode can be adjusted and saved by using the <Color> menu of the Adjustment menu.

In the analog input, perform the "Range Adjustment" before making the color adjustments. Never change the CAL Switch mode during color adjustment. Select the mode in advance by using 

Adjustment Items

The adjustable items and displayed icons on the <Color> menu depend on the selected CAL Switch mode.

"√": Settable/Adjustable "–": Fixed at the factory









Icons	Functions	CAL Switch Mode			
		DICOM-CL	Text	Cutom	CAL
	Brightness*	–	√	√	–
	Temperature*	–	√	√	–
	Gamma*	–	√	√	–
	Saturation	–	√	√	–
	Hue	–	√	√	–
	Gain	–	–	√	–
	6 Colors	–	–	√	–
	Reset	–	√	√	–

* These settings can be also adjusted on the CAL Switch menu. (See CAL Switch.)

NOTE

- Allow the LCD monitor to stabilize for at least 30 minutes before making image adjustments. (Allow the monitor to warm up for at least 30 minutes before making adjustments.)
- The values shown in percentages represent the current level within the specific adjustment. They are available only as a reference tool. (To create a uniform white or black screen, the percentages for each will probably not be the same.)

Adjustment Contents

Menu	Function Descriptions	Adjustable range
Brightness 	To set the brightness of the screen	0~100%
	Tips <ul style="list-style-type: none"> • The values shown in the “%” are available only as reference. 	
Temperature 	To set the color temperature	6500K~15000K in 500 K increments (including 9300 K)
	Tips <ul style="list-style-type: none"> • The values shown in the Kelvin are available only as a reference tool. • While color temperature is adjusted, <Gain> is adjusted automatically according to the color temperature. • Setting the temperature under 6500 K or over 15000 K invalidates the color temperature setting. (The color temperature's setting turns "OFF".) • Setting the <Gain> invalidates the <Temperature> adjustment. 	
Gamma 	To set the gamma value	1.8~2.6
Saturation 	To change the saturation	-100~100 Setting the minimum level (-100) turns the image to the monochrome.
	NOTE <ul style="list-style-type: none"> • The <Saturation> adjustment may cause undisplayable color tone. 	
Hue 	To change the flesh color, etc.	-100~100
	NOTE <ul style="list-style-type: none"> • Using <Hue> adjustment may not obtain proper tone reproduction. 	
Gain 	To change each color (red, green and blue)	0~100% By adjusting the red, green and blue color tones for each mode, custom colors can be defined. Display a white or gray background image and adjust the <Gain>.
	Tips <ul style="list-style-type: none"> • The values shown in the “%” are available only as reference. • The <Temperature> setting invalidates this setting. The <Gain> setting varies with color temperature. 	
6 Colors 	To adjust <Saturation> and <Hue> in each color (Red, Yellow, Green, Cyan, Blue and Magenta)	Hue: -100 ~ 100 Saturation: -100 ~ 100
Reset 	To return the color settings to the default settings	Select the <Reset>.

3-4. Power-save Setup

The <PowerManager> menu in the Adjustment menu enables to set the power-save setup.

NOTE

- Do your part to conserve energy, turn off the monitor when you are finished using it. Disconnecting the monitor from the power supply is recommended to save energy completely.
- Even if the monitor is in a power saving mode, USB compliant devices function when they are connected to the monitor's USB (both the upstream and the downstream ports). Therefore, power consumption of the monitor will change according to the connected devices even if the monitor is in a power saving mode.

Analog Input

This monitor complies with the "VESA DPMS" standard and adopts a power saving method.

[Procedure]

1. Set the PC's power saving settings.
2. Select "VESA DPMS" from the <PowerManager> menu.

[Power Saving System]

PC		Monitor	Power Indicator
Operation		Operation	Blue
Power saving	STAND-BY SUSPEND OFF	Power saving	Orange

[Power Resumption Procedure]

Operate the mouse or keyboard to return to a normal screen.

Digital Input

This monitor complies with the "DVI DMPM"

[Procedure]

1. Set the PC's power saving settings.
2. Select "DVI DMPM" from the <PowerManager> menu.

[Power Saving System]

The monitor enters the power saving mode in five seconds in connection with the PC setting.

PC		Monitor	Power Indicator
Operation		Operation	Blue
Power saving		Power saving	Orange

[Power Resumption Procedure]

Operate the mouse or keyboard to return to a normal screen.

3-5. Off Timer

The off timer function causes the monitor to automatically enter a power off state after a predetermined amount of time has lapsed. This function was created to reduce Afterimage characteristics that are particular to LCD monitors when the monitor screen is left on for a long period without use.

[Procedure]

1. Select <Off Timer> in the Adjustment menu <Others> menu.
2. Select "Enable" and touch the Right and Left directing switches to adjust the operating time (1 to 23 hours).

[Off Timer System]

PC	Monitor	Power Indicator
Operating time (1H - 23H)	Operation	Blue
Last 15 min. in operating time	Advance Notice *1	Blue Flashing
Operating time expired	Power Off	Off

*1 When  is pressed during the advance notice period, the monitor continues to operate for additional 90 minutes. Extension of operation time can be set without limitation.

[Power Resumption Procedure]







Press  to return a normal screen.

NOTE

- The off timer function works while the PowerManager is active, but there is no advance notice before the monitor's power is turned off.

3-6. Locking the settings

Use the "Adjustment Lock" function to prevent any accidental changes.

Buttons that can be locked	<ul style="list-style-type: none"> •  (Enter button) / Adjustments/settings using •  (Mode button) •  (Auto Adjustment button)
Buttons that cannot be locked	<ul style="list-style-type: none"> •  (Input Signal Selection button) •  (Power button) •  (Adjustment Lock button)

[How to lock]

Press  for at least 2 seconds to lock the settings.

[How to unlock]

Press  for at least 2 seconds to release the lock.

NOTE

- The adjustment lock function may activate when calibration is performed with the calibration kit. The monitor can be unlocked using the same unlocking procedure described above.

3-7. Power Indicator Setting

Light off the power indicator. This function is available for the multiple panels settings.

[Procedure]

1. Select <Power Indicator> in the Adjustment menu <Others> menu.
2. Select "Disable".

3-8. Automatic brightness adjustment

The sensor on the front side of the monitor detects the environmental brightness to adjust the screen brightness automatically and comfortably.

[Procedure]

1. Select <BrightRegulator> in the Adjustment menu <Others> menu.
2. Select "Enable".

NOTE



- This function is not available in the DICOM-CL and CAL modes.
-

3-9. Displaying Lower Resolutions

The lower resolutions are enlarged to full screen automatically. Using the <Screen Size> function in the <Others> menu enables to change the screen size.

1 Enlarge the screen size when displaying a low resolution.

→  Select the <Screen Size>.

Select the <Screen Size> in the <Others> menu and select the screen size by using  and .

Mode	Function
Full	Displays the picture on the screen in full, irrespective of the picture's resolution. Since the vertical resolution and the horizontal resolution are enlarged at different rates, some images may appear distorted.
Enlarged	Displays the picture on the screen in full, irrespective of the picture's resolution. Since the vertical resolution and horizontal resolution are enlarged at same rates, some horizontal or vertical image may disappear.
Normal	Displays the picture at the actual Screen resolution.

Example: Displaying 1280 x 1024

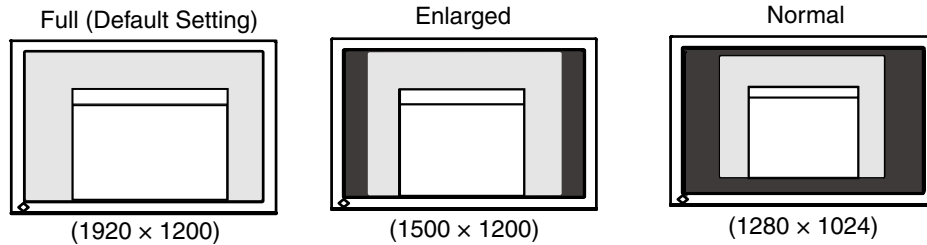

2 Smooth the blurred texts of the enlarged screen.

→  Switch the <Smoothing> setting.

Select the suitable level from 1 - 5 (Soft - Sharp).

Select <Smoothing> in the <Screen> menu and adjust by using the right and left switches.

NOTE

- <Smoothing> is disabled in the following cases.
 - Screen is displayed in the 1920 x 1200.
 - "Enlarged" is selected in <Screen Size> at 800 x 600 resolution.
 - "Enlarged" is selected in <Screen Size> at 1600 x 1200 resolution.
 - "Normal" is selected in <Screen Size>.

3 Set the brightness of the black area surrounding the displayed image.

→  Set the <Border Intensity>.

In the "Enlarge" mode or "Full Screen" mode, the outer area (border) is usually black. Select <BorderIntensity> in the <Others> menu and adjust by using .

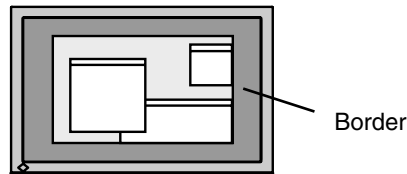

3-10. Setting the orientation of the Adjustment menu

The orientation of the Adjustment menu can be changed.

[Procedure]

1. Select <Menu Settings> in the Adjustment menu <Others> menu.
2. Select <Orientation> in the <Menu Settings> menu.
3. Use  to select between "Portrait" and "Landscape".
4. Turn the monitor screen 90° in clockwise direction.

NOTE

- Be sure that the cables are correctly connected.



Tips

- For using the monitor with "Portrait" position, the graphics board supporting portrait display is required. When using the monitor with "Portrait" position, the setting needs to be changed depending on the graphics board used in your PC. Refer to the manual of the graphics board for details.



3-11. EIZO Logo Appearing Function

When switching on the power button on the front control panel, the EIZO logo is displayed for a while. If you desire to display or undisplay this logo, use this function. (Default is logo appearing.)

[To undisplay]

1. Press  to turn off the unit.
 2. Press  again while pressing .
- The EIZO logo does not appear on the screen.



[To display]



1. Press  to turn off the unit.
 2. Press  again while pressing .
- The EIZO logo appear on the screen.

4. Troubleshooting

If a problem still remains after applying the suggested remedies, contact your local dealer.

- No-picture problems : See No.1 - No.2
- Imaging problems : See No.3 - No.14
- Other problems : See No.15 - No.18
- USB problems : See No.19 - No.20

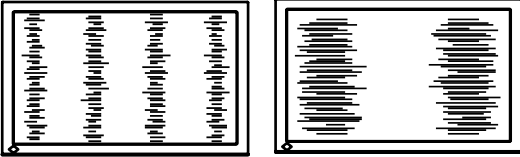
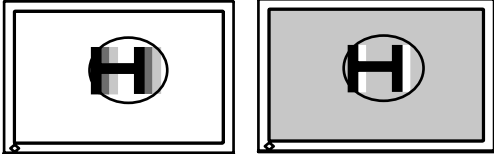
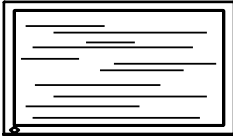
Problems	Possible cause and remedy
<p>1. No picture</p> <ul style="list-style-type: none"> • Power indicator does not light. • Power indicator is lighting blue. • Power indicator is lighting orange. 	<ul style="list-style-type: none"> • Check whether the power cord is connected correctly. If the problem persists, turn off the monitor, and then turn it on again a few minutes later. • Press . • Set each RGB adjusting value in <Gain> to higher level. (page 22). • Switch the input signal with . • Operate the mouse or keyboard. • Turn on the PC.
<p>2. The message below appears.</p> <ul style="list-style-type: none"> • This message appears when no signal is input. (This is displayed for about 40 seconds) <div data-bbox="316 1048 746 1272" style="border: 2px solid black; padding: 10px; text-align: center;"> <p>Signal Check</p> <p>Signal 2</p> <p>fH: 0.0kHz</p> <p>fV: 0.0Hz</p> </div>	<p>This message appears when the signal is not input correctly even when the monitor functions properly.</p> <ul style="list-style-type: none"> • The message shown left may appear, because some PCs do not output the signal soon after power-on. • Check whether the PC is turned on. • Check whether the signal cable is connected properly. • Switch the input signal with .
<ul style="list-style-type: none"> • The message below shows that the input signal is out of the specified frequency range. (Such signal frequency is displayed in red.) <p>Example:</p> <div data-bbox="316 1518 746 1742" style="border: 2px solid black; padding: 10px; text-align: center;"> <p>Signal Error</p> <p>Signal 2</p> <p>fD: 165.0MHz</p> <p>fH: 75.0kHz</p> <p>fV: 60.0Hz</p> </div>	<ul style="list-style-type: none"> • Reboot the PC. • Select an appropriate display mode using the graphics board's utility. Refer to the manual of the graphics board for details.

Problems	Possible cause and remedy
<p>3. Display position is incorrect.</p> 	<ul style="list-style-type: none"> • Adjust image position so that it is displayed properly within the display area using the <Position> adjustment (page 19). • Adjust image position so that it is displayed properly within the display area using the "Hor.Position" and "Ver. Position" adjustment (page 19). • If the problem persists, use the graphics board's utility if available to change the display position.
<p>4. Screen image displayed is smaller or larger than the actual screen image.</p>	<ul style="list-style-type: none"> • Adjust the resolution using <Resolution> so that the input signal resolution equals the resolution in the resolution adjustment menu (page 19).
<p>5. Vertical bars appear on the screen or a part of the image is flickering.</p> 	<ul style="list-style-type: none"> • Adjust using <Clock> (page 18).
<p>6. The characters and images have several vertical bars on their right side.</p> 	<ul style="list-style-type: none"> • Adjust the characters and images using the <Signal Filter>.
<p>7. Whole screen is flickering or blurring.</p> 	<ul style="list-style-type: none"> • Adjust using <Phase> (page 18).
<p>8. Characters are blurred.</p>	<ul style="list-style-type: none"> • Adjust using <Smoothing> (page 26).
<p>9. Upper part of the screen is distorted as shown below.</p> 	<ul style="list-style-type: none"> • This is caused when both composite sync (X-OR) signal and separate vertical sync signal are input simultaneously. Select either composite signal or separate signal
<p>10. The screen is too bright or too dark.</p>	<ul style="list-style-type: none"> • Adjust <Brightness>. (The LCD monitor backlight has a fixed life span. When the screen becomes dark or begins to flicker, contact your local dealer.)
<p>11. Afterimages appear.</p>	<ul style="list-style-type: none"> • Use a screen saver or off timer function for a long-time image display. • Afterimages are particular to LCD monitors. Avoid displaying the same image for a long time.
<p>12. Green/red/blue/white dots or defective dots remain on the screen.</p>	<ul style="list-style-type: none"> • This is due to LCD panel characteristics and is not a failure.
<p>13. Interference patterns or fingerprints remain on the screen.</p>	<ul style="list-style-type: none"> • Leave the monitor with a white screen or a black screen. The symptom may disappear.

Problems	Possible cause and remedy
14.Noise appears on the screen.	<ul style="list-style-type: none"> • When entering the signals of analog input, select 1 to 4 in <Signal Filter> from the <Screen> menu to change the mode. • When entering the signals of HDCP system, the normal images may not be displayed immediately.
15.The <Smoothing> icon on the Adjustment menu <Screen> cannot be selected.	<ul style="list-style-type: none"> • <Smoothing> is disabled when the screen is displayed in the following resolutions. <ul style="list-style-type: none"> •1920 × 1200 •Select "Enlarged" during <Screen Size> in the resolution of 800 × 600 •Select "Enlarged" during <Screen Size> in the resolution of 1600 × 1200 •Select "Normal" during <Screen Size> mode.
16.The Main menu of Adjustment menu does not start.	<ul style="list-style-type: none"> • Check for Adjustment Lock function (page 24).
17.The CAL Switch mode is not displayed.	<ul style="list-style-type: none"> • Check for Adjustment Lock function (page 24).
18.Ⓐ does not function.	<ul style="list-style-type: none"> • Ⓐ does not function when digital signal is input. • Check for Adjustment Lock function (page 24).
19.PC is hung up. / The peripherals connected to the downstream ports do not operate.	<ul style="list-style-type: none"> • Check that the USB cable is correctly connected. • Check the downstream ports by connecting the peripherals to other downstream ports. If the problem is solved by doing this, contact an EIZO dealer. (For details, refer to the manual of the PC.) • Try executing the following method. <ul style="list-style-type: none"> •Restarting the PC •Connecting the PC and peripherals directly <p>If the problem is solved by doing this, contact an EIZO dealer.</p>
20.USB function cannot be setup.	<ul style="list-style-type: none"> • Check that the USB cable is correctly connected. • Check that the PC and OS are USB compliant. (For verification of USB support, consult the manufacturer of each system.) • Check the PC's BIOS setting for USB. (For details, refer to the manual of the PC.)

5. Reference

5-1. Attaching an arm

The LCD monitor can be used with an arm by removing the tilt stand and attaching the arm stand to the LCD monitor.

NOTE

- When attaching an arm or stand, follow the instructions of their user's manual.
- When using another manufacturer's arm or stand, confirm the following in advance and select one conforming to the VESA standard.
 - Hole spacing on the arm mounting: 100 mm x 100 mm
 - Thickness of plate: 2.6 mm
 - Strong enough to support weight of the monitor unit (except the stand) and attachments such as cables.
- When using an arm or stand, attach it to meet the following tilt angles of the monitor.
 - Up 45 degrees, down 45 degrees (horizontal display, and vertical display rotated 90 degrees clockwise)
- Please connect cables after attaching an arm stand.
- Since the monitor and arm are so heavy, dropping them may result in injury or equipment damage.

Setup Procedure

1 Lay the LCD monitor down. Do not scratch the panel.

2 Remove the tilt stand by loosening the screws.

Unscrew the four screws securing the unit and the stand with the screwdriver.

3 Attach an arm stand to the LCD monitor securely.

Secure the monitor to the arm or stand using the screws specified in the user's manual of the arm or stand.

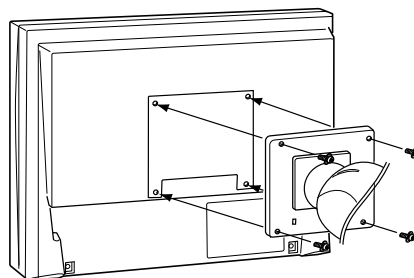

5-2. Specifications

LCD Panel		61 cm (24.1 inch), TFT color LCD panel Surface treatment : Anti-Glare Hard Coating Surface hardness : 3H Response Time : 16ms
Viewing Angle		Horizontal : 178°, Vertical : 178°(CR: 10 or more)
Dot Pitch		0.270mm
Horizontal Scan Frequency	Analog	24~94 kHz (Automatic)
	Digital	31~76 kHz
Vertical Scan Frequency	Analog	49~86 Hz (Automatic) (1600x1200 : 49 ~ 76 Hz) (1920x1200 : 49 ~ 61 Hz)
	Digital	59 ~ 61 Hz (VGA TEXT: 69 ~ 71 Hz)
Resolution		1920 dots x 1200 lines
Dot Clock (Max.)	Analog	202.5 MHz
	Digital	162 MHz
Display Colors		16.77 million colors (max.)
Display Area		518.4 mm (H) × 324.0 mm (V) (20.4" (H) × 12.8" (V))
Power Supply		100-120/200-240 VAC±10%, 50/60 Hz, 1.0 A/0.5A (with USB)
Power Consumption	Screen Display On	100 W (with USB) 90W (without USB)
	Power Saving Mode	Less than 2 W (for single signal input without USB)
	Power switch Off	1 W or less
Input Signal Connector		DVI-I connector (Applicable to HDCP)×2
Analog Input Signal (Sync)		Separate, TTL, Positive/Negative Composite, TTL, Positive/Negative
Analog Input Signal (Video)		0.7 Vp-p / 75 ohms, Positive
Input Signal (Digital)		TMDS (Single Link)
Signal registration	Analog	45 (Factory preset: 30)
	Digital	10 (Factory preset: 0)
Plug & Play		VESA DDC 2B / EDID structure 1.3
Dimensions	with stand	566 mm (W) x 456 ~ 538 mm (H) x 208.5 mm (D) (22.3"(W) x 18" ~ 21.2" (H) x 8.2"(D))
	without stand	566 mm (W) x 367 mm (H) x 85 mm (D) (22.3"(W) x 14.4" (H) x 3.35"(D))
Weight	with stand	10.4 kg (22.9 lbs.)
	without stand	7.4 kg (16.3 lbs.)
Environment Conditions	Temperature	Operating : 0°C to 35°C (32°F to 95°F) Transportation/Storage : -20°C to 60°C (-4°F to 140°F)
	Humidity	Operating : 30% to 80% R.H. Non-condensing Transportation/Storage : 30% to 80% R.H. Non-condensing
	Pressure	Operating : 700 hPa to 1060 hPa. Transportation/Storage : 200 hPa to 1060 hPa.
USB	standard	USB Specification Revision 2.0
	USB port	Upstream port x 1 Downstream port x 2
	Communication Speed	480 Mbps (high), 12 Mbps (full), 1.5 Mbps (low)
	Power Supply	Downstream: 500 mA for each (max.)
Classification of Equipment		Type of protection against electric shock : Class I EMC class: EN60601-1-2:2007 Group 1 Class B Classification of medical device (MDD 93/42/EEC) : Class I Mode of operation : Continuous IP Class : IPX0

Default settings

CAL Switch Mode : The default display mode setting is **DICOM-CL** mode.

	Brightness	Temperature	Gamma
Custom	approx. 320 cd/m ²	Off	2.2
Text	approx. 100 cd/m ²	7500K	2.2
DICOM-CL	170 cd/m ²	7500K	DICOM
CAL	170 cd/m ²	7500K	DICOM

Others

Smoothing	3		
PowerManager	Analog input : VESA DPMS Digital input:DVI DMPM		
Screen Size	Full		
Off Timer	Disable		
Menu Settings	Menu Size	Normal	
	Menu Off Timer	45 sec	
BrightRegulator	Disable		
Language	English		

Dimensions

unit : mm (inch)

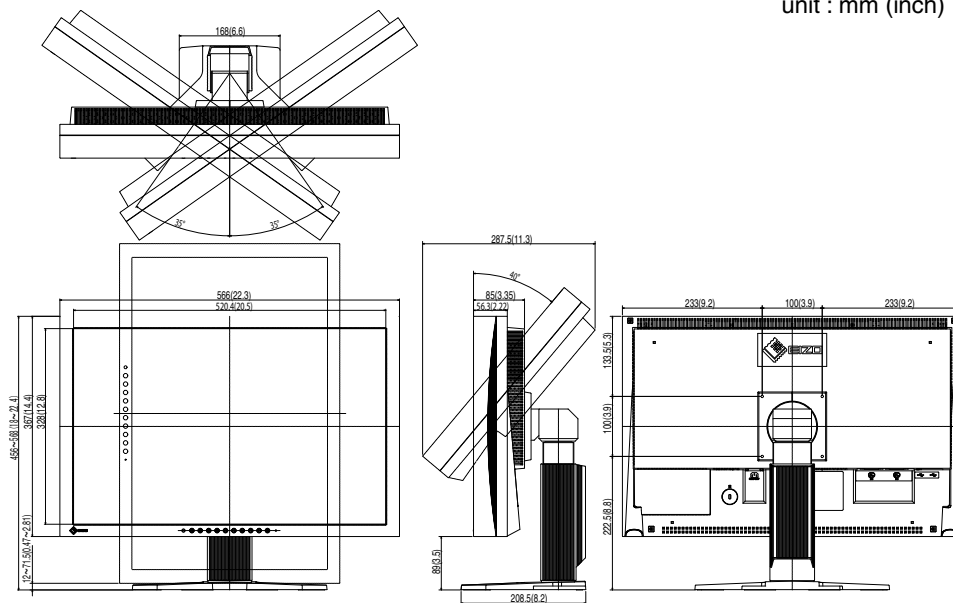

Optional

Calibration Kit	EIZO "RadiCS UX1" Ver.3.2.2 or later
Network QC Management Software	EIZO "RadiNET Pro" Ver.3.2.2 or later
Cleaning Kit	EIZO "ScreenCleaner"

For the latest information about the accessories and information about the latest compatible graphics board, refer to our web site.

<http://www.eizo.com>

Pin Assignment

•DVI-I Connector

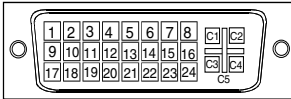

Pin No.	Signal	Pin No.	Signal	Pin No.	Signal
1	TMDS Data 2-	11	TMDS Data1/3 Shield	21	NC*
2	TMDS Data 2+	12	NC*	22	TMDS Clock shield
3	TMDS Data2/4 Shield	13	NC*	23	TMDS Clock+
4	NC*	14	+5V Power	24	TMDS Clock-
5	NC*	15	Ground (return for +5V, Hsync and Vsync)	C1	Analog Red
6	DDC Clock (SCL)	16	Hot Plug Detect	C2	Analog Green
7	DDC Data (SDA)	17	TMDS Data0-	C3	Analog Blue
8	Analog Vertical Sync	18	TMDS Data0+	C4	Analog Horizontal Sync
9	TMDSData1-	19	TMDS Data0/5 Shield	C5	Analog Ground(analog R,G,&B return)
10	TMDS Data1+	20	NC*		

(*NC: No Connection)

•USB Port
Upstream

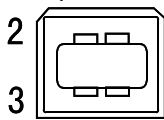

Series B
Connector

Downstream

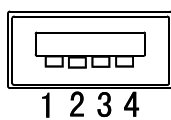

Series A
Connector

No.	Signal	Remarks
1	VCC	Cable power
2	- Data	Serial data
3	+ Data	Serial data
4	Ground	Cable Ground

5-3. Glossary

Clock

With the analog input signal display, the analog signal is converted to a digital signal by the LCD circuitry. To convert the signal correctly, the LCD monitor needs to produce the same number clock pulse as the dot clock of the graphics system. When the clock pulse is not correctly set, some vertical bars of distortion are displayed on the screen.

DICOM (Digital Imaging and Communication in Medicine)

DICOM is a standard for digital imaging and communication for medical use developed by American College of Radiology and National Electric Manufacturers Association.

DVI (Digital Visual Interface)

A digital flat panel interface. DVI can transmit digital data from the PC directly without loss with the signal transition method "TMDS". There are two kinds of DVI connectors. One is DVI-D connector for digital signal input only. The other is DVI-I connector for both digital and analog signal inputs.

DVI DMPM (DVI Digital Monitor Power Management)

The Power management system for the digital interface. The "Monitor ON" status (operation mode) and the "Active Off" status (power-saving mode) are indispensable for the DVI-DMPM as the monitor's power mode.

Gain Adjustment

Adjusts each color parameter for red, green and blue. The color of the LCD monitor is displayed through the color filter of the LCD panel. Red, green and blue are the three primary colors. The colors on the monitor are displayed by combining these three colors. The color tone can change by adjusting the illumination amount passed through each color's filter.

Gamma

Generally, the relationship that the light intensity values of a monitor change nonlinearly to the input signal level is called "Gamma Characteristic". On the monitor, low gamma values display the whitish images and high gamma values display the high contrast images.

HDCP (High-bandwidth Digital Contents Protection)

Digital signal coding system developed to copy-protect the digital contents, such as video, music, etc. This helps to transmit the digital contents safely by coding the digital contents sent via DVI terminal on the output side and decoding them on the input side.

Any digital contents cannot be reproduced if both of the equipments on the output and input sides are not applicable to HDCP system.

Phase

The phase adjustment decides the sampling timing point for converting the analog input signal to a digital signal. Adjusting the phase after the clock adjustment will produce a clear screen.

Range Adjustment

The Range Adjustment controls the level of output signal range to display the whole color gradation.

Resolution

The LCD panel consists of a fixed number of pixel elements which are illuminated to form the screen image. This monitor consists of 1920 horizontal pixels and 1200 vertical pixels. At a resolution of 1920 x 1200 , all pixels are displayed as a full screen.

Temperature

Color Temperature is a method to measure the white color tone, generally indicated in degrees Kelvin. At high temperatures the white tone appears somewhat blue, while at lower temperatures it appears somewhat red. Computer monitors generally give best performance at high temperature settings.

5000 K: Slightly reddish white.

6500 K: Warm-white tone, similar to white paper or daylight.

9300 K: Slightly bluish white.

TMDS (Transition Minimized Differential Signaling)

A signal transition method for the digital interface.

VESA DPMS

(Video Electronics Standards Association - Display Power Management Signaling)

The acronym VESA stands for "Video Electronics Standards Association", and DPMS stands for "Display Power Management Signaling". DPMS is a communication standard that PCs and graphics boards use to implement power savings on the monitor side.

6. APPENDIX/ANHANG/ANNEXE

Preset Timing Chart for Analog input Timing-Übersichten für Analog Eingang Synchronisation des Signaux pour Analog numerique

NOTE

- Based on the signal diagram shown below factory presets have been registered in the monitor's microprocessor.
- Der integrierte Mikroprozessor des Monitors unterstützt werkseitige Standardeinstellungen (siehe hierzu die nachfolgenden Diagramme).
- Signaux ont été enregistrés en usine dans le microprocesseur du moniteur, conformément au diagramme de synchronisation ci-dessous.

Mode	Dot Clock MHz		Frequencies	
			Horizontal:kHz	Vertical:Hz
VGA 640×480@60Hz	25.2 MHz	Horizontal	31.47	Negative
		Vertical	59.94	Negative
VGA TEXT 720×400@70Hz	28.3 MHz	Horizontal	31.47	Negative
		Vertical	70.09	Positive
Macintosh 640×480@67Hz	30.2 MHz	Horizontal	35.00	Negative
		Vertical	66.67	Negative
Macintosh 832×624@75Hz	57.3 MHz	Horizontal	49.73	Negative
		Vertical	74.55	Negative
Macintosh 1152×870@75Hz	100.0 MHz	Horizontal	68.68	Negative
		Vertical	75.06	Negative
Macintosh 1280×960@75Hz	126.2 MHz	Horizontal	74.76	Positive
		Vertical	74.76	Positive
VESA 640×480@72Hz	31.5 MHz	Horizontal	37.86	Negative
		Vertical	72.81	Negative
VESA 640×480@75Hz	31.5 MHz	Horizontal	37.50	Negative
		Vertical	75.00	Negative
VESA 640×480@85Hz	36.0 MHz	Horizontal	43.27	Negative
		Vertical	85.01	Negative
VESA 800×600@56Hz	36.0 MHz	Horizontal	35.16	Positive
		Vertical	56.25	Positive
VESA 800×600@60Hz	40.0 MHz	Horizontal	37.88	Positive
		Vertical	60.32	Positive
VESA 800×600@72Hz	50.0 MHz	Horizontal	48.08	Positive
		Vertical	72.19	Positive
VESA 800×600@75Hz	49.5 MHz	Horizontal	46.88	Positive
		Vertical	75.00	Positive
VESA 800×600@85Hz	56.3 MHz	Horizontal	53.67	Positive
		Vertical	85.06	Positive
VESA 1024×768@60Hz	65.0 MHz	Horizontal	48.36	Negative
		Vertical	60.00	Negative
VESA 1024×768@70Hz	75.0 MHz	Horizontal	56.48	Negative
		Vertical	70.07	Negative
VESA 1024×768@75Hz	78.8 MHz	Horizontal	60.02	Positive
		Vertical	75.03	Positive
VESA 1024×768@85Hz	94.5 MHz	Horizontal	68.68	Positive
		Vertical	85.00	Positive
VESA 1152×864@75Hz	108.0 MHz	Horizontal	67.50	Positive
		Vertical	75.00	Positive
VESA 1280×960@60Hz	108.0 MHz	Horizontal	60.00	Positive
		Vertical	60.00	Positive
VESA 1280×1024@60Hz	108.0 MHz	Horizontal	63.98	Positive
		Vertical	60.02	Positive
VESA 1280×1024@75Hz	135.0 MHz	Horizontal	79.98	Positive
		Vertical	75.03	Positive
VESA 1280×1024@85Hz	157.5 MHz	Horizontal	91.15	Positive
		Vertical	85.03	Positive
VESA 1600×1200@60Hz	162.0 MHz	Horizontal	75.00	Positive
		Vertical	60.00	Positive
VESA 1600×1200@65Hz	175.0 MHz	Horizontal	81.30	Positive
		Vertical	65.00	Positive

Mode	Dot Clock MHz		Frequencies		Sync Polarity
			Horizontal:kHz	Vertical:Hz	
VESA 1600×1200@70Hz	189.0 MHz	Horizontal	87.50	Positive	
		Vertical	70.00	Positive	
VESA 1600×1200@75Hz	202.5 MHz	Horizontal	93.75	Positive	
		Vertical	75.00	Positive	
VESA CVT 1680×1050 60Hz	146.3 MHz	Horizontal	65.29	Negative	
		Vertical	59.95	Positive	
VESA CVT 1920×1200 60Hz	193.3 MHz	Horizontal	74.56	Negative	
		Vertical	59.89	Positive	
VESA CVT RB 1920×1200 60Hz	154.0 MHz	Horizontal	74.04	Positive	
		Vertical	59.95	Negative	

For U.S.A. , Canada, etc. (rated 100-120 Vac) Only

FCC Declaration of Conformity

We, the Responsible Party

EIZO Inc.

5710 Warland Drive, Cypress, CA 90630

Phone: (562) 431-5011

declare that the product

Trade name: EIZO

Model: RadiForce MX240W

is in conformity with Part 15 of the FCC Rules. Operation of this product is subject to the following two conditions: (1) this device may not cause harmful interference, and (2) this device must accept any interference received, including interference that may cause undesired operation.

This equipment has been tested and found to comply with the limits for a Class B digital device, pursuant to Part 15 of the FCC Rules. These limits are designed to provide reasonable protection against harmful interference in a residential installation. This equipment generates, uses, and can radiate radio frequency energy and, if not installed and used in accordance with the instructions, may cause harmful interference to radio communications. However, there is no guarantee that interference will not occur in a particular installation. If this equipment does cause harmful interference to radio or television reception, which can be determined by turning the equipment off and on, the user is encouraged to try to correct the interference by one or more of the following measures.

- * Reorient or relocate the receiving antenna.
- * Increase the separation between the equipment and receiver.
- * Connect the equipment into an outlet on a circuit different from that to which the receiver is connected.
- * Consult the dealer or an experienced radio/TV technician for help.

Changes or modifications not expressly approved by the party responsible for compliance could void the user's authority to operate the equipment.

Note

Use the attached specified cable below or EIZO signal cable with this monitor so as to keep interference within the limits of a Class B digital device.

- AC Cord
- Shielded Signal Cable (Enclosed)

Canadian Notice

This Class B digital apparatus complies with Canadian ICES-003.

Cet appareil numérique de la classe B est conforme à la norme NMB-003 du Canada.

EMC Information

Essential performance of RadiForce series is to display images and operate functions normally.



CAUTION

The RadiForce series requires special precautions regarding EMC and need to be installed, put into service and used according to the following information.

Do not use any cables other than the cables that provided or specified by us.

Using other cables may cause the increase of emission or decrease of immunity.

Do not put any portable and mobile RF communications equipment close to the RadiForce series.

Doing so may affect the RadiForce series.

The RadiForce series should not be used adjacent to or stacked with other equipment. If adjacent or stacked use is necessary, the equipment or system should be observed to verify normal operation in the configuration in which it will be used.

Guidance and manufacturer's declaration - electromagnetic emissions		
The RadiForce series is intended for use in the electromagnetic environment specified below. The customer or the user of the RadiForce series should assure that it is used in such an environment.		
Emission test	Compliance	Electromagnetic environment - guidance
RF emissions EN55011	Group 1	The RadiForce series uses RF energy only for its internal function. Therefore, its RF emission are very low and are not likely to cause any interference in nearby electronic equipment.
RF emissions EN55011	Class B	The RadiForce series is suitable for use in all establishments, including domestic establishments and those directly connected to the public low-voltage power supply network that supplies buildings used for domestic purposes.
Harmonic emissions EN61000-3-2	Class D	
Voltage fluctuations / flicker emissions EN61000-3-3	Complies	

Guidance and manufacturer's declaration - electromagnetic immunity			
The RadiForce series is intended for use in the electromagnetic environment specified below. The customer or the user of the RadiForce series should assure that it is used in such an environment.			
Immunity test	IEC60601 test level	Compliance level	Electromagnetic environment - guidance
Electrostatic discharge (ESD) EN61000-4-2	±6kV contact ±8kV air	±6kV contact ±8kV air	Floors should be wood, concrete or ceramic tile. If floors are covered with synthetic material, the relative humidity should be at least 30%.
Electrical fast transient / burst EN61000-4-4	±2kV for power supply lines ±1kV for input/output lines	±2kV for power supply lines ±1kV for input/output lines	Mains power quality should be that of a typical commercial or hospital environment.
Surge EN61000-4-5	±1kV line(s) to line(s) ±2kV line(s) to earth	±1kV line(s) to line(s) ±2kV line(s) to earth	Mains power quality should be that of a typical commercial or hospital environment.
Voltage dips, short interruptions and voltage variations on power supply input lines EN61000-4-11	<5% U_T (>95% dip in U_T) for 0.5 cycle 40% U_T (60% dip in U_T) for 5 cycles 70% U_T (30% dip in U_T) for 25 cycles <5% U_T (>95% dip in U_T) for 5sec	<5% U_T (>95% dip in U_T) for 0.5 cycle 40% U_T (60% dip in U_T) for 5 cycles 70% U_T (30% dip in U_T) for 25 cycles <5% U_T (>95% dip in U_T) for 5sec	Mains power quality should be that of a typical commercial or hospital environment. If the user of the RadiForce series requires continued operation during power mains interruptions, it is recommended that the RadiForce series be powered from an uninterruptible power supply or a battery.
Power frequency (50/60Hz) magnetic field EN61000-4-8	3A/m	3A/m	Power frequency magnetic fields should be at levels characteristic of a typical location in a typical commercial or hospital environment.
NOTE U_T is the a.c. mains voltage prior to application of the test level.			

Guidance and manufacturer's declaration - electromagnetic immunity

The RadiForce series is intended for use in the electromagnetic environment specified below. The customer or the user of the RadiForce series should assure that it is used in such an environment.

Immunity test	IEC60601 test level	Compliance level	Electromagnetic environment - guidance
Conducted RF EN61000-4-6	3Vrms 150kHz to 80MHz	3V	<p>Portable and mobile RF communications equipment should be used no closer to any part of the RadiForce series, including cables, than the recommended separation distance calculated from the equation applicable to the frequency of the transmitter.</p> <p>Recommended Separation distance</p> $d = 1.2 \sqrt{P}$ $d = 1.2 \sqrt{P}, 80\text{MHz to } 800\text{MHz}$ $d = 2.3 \sqrt{P}, 800\text{MHz to } 2.5\text{GHz}$ <p>Where "P" is the maximum output power rating of the transmitter in watts (W) according to the transmitter manufacturer and "d" is the recommended separation distance in meters (m).</p> <p>Field strengths from fixed RF transmitters, as determined by an electromagnetic site survey^a, should be less than the compliance level in each frequency range^b.</p> <p>Interference may occur in the vicinity of equipment marked with the following symbol.</p> 
Radiated RF EN61000-4-3	3V/m 80MHz to 2.5GHz	3V/m	

NOTE 1 At 80 MHz and 800 MHz, the higher frequency range applies.

NOTE 2 These guidelines may not apply in all situations. Electromagnetic propagation is affected by absorption and reflection from structures, objects and people.

^a Field strengths from fixed transmitters, such as base stations for radio (cellular/cordless) telephones and land mobile radios, amateur radio, AM and FM radio broadcast and TV broadcast cannot be predicted theoretically with accuracy. To assess the electromagnetic environment due to fixed RF transmitters, an electromagnetic site survey should be considered. If the measured field strength in the location in which the RadiForce series is used exceeds the applicable RF compliance level above, the RadiForce series should be observed to verify normal operation. If abnormal performance is observed, additional measures may be necessary, such as reorienting or relocating the RadiForce series.

^b Over the frequency range 150 kHz to 80 MHz, field strengths should be less than 3 V/m.

Recommended separation distances between portable and mobile RF communications equipment and the RadiForce Series

The RadiForce series is intended for use in an electromagnetic environment in which radiated RF disturbances are controlled. The customer or the user of the RadiForce series can help prevent electromagnetic interference by maintaining a minimum distance between portable and mobile RF communications equipment (transmitters) and the RadiForce series as recommended below, according to the maximum output power of the communications equipment.

Rated maximum output power of transmitter W	Separation distance according to frequency of transmitter m		
	150kHz to 80MHz $d = 1.2 \sqrt{P}$	80MHz to 800MHz $d = 1.2 \sqrt{P}$	800MHz to 2.5GHz $d = 2.3 \sqrt{P}$
0.01	0.12	0.12	0.23
0.1	0.38	0.38	0.73
1	1.2	1.2	2.3
10	3.8	3.8	7.3
100	12	12	23

For transmitters rated at a maximum output power not listed above, the recommended separation distance “d” in meters (m) can be estimated using the equation applicable to the frequency of the transmitter, where “P” is the maximum output power rating of the transmitter in watts (W) according to the transmitter manufacturer.

NOTE 1 At 80 MHz and 800 MHz, the separation distance for the higher frequency range applies.

NOTE 2 These guidelines may not apply in all situations. Electromagnetic propagation is affected by absorption and reflection from structures, objects and people.

Cable length		
Power Cord :	Accessory	2.0m
Signal Cable (FD-C39) :	Accessory	2.0m
Signal Cable (FD-C16) :	Accessory	2.0m
USB Cable (MD-C93) :	Accessory	1.8m

