



Installation Manual

RadiForce® MX317W

Color LCD Monitor

Important

To ensure that the product is used correctly, carefully read through this Installation Manual and the Instructions for Use before use.

- See the Instructions for Use for monitor installation and connection.
- You can check the latest product information, including the Installation Manual, from our web site.
www.eizoglobal.com

This product has been adjusted specifically for use in the region to which it was originally shipped.
If operated outside this region, the product may not perform as stated in the specifications.

No part of this manual may be reproduced, stored in a retrieval system, or transmitted, in any form or by any means, electronic, mechanical, or otherwise, without the prior written permission of EIZO Corporation.

EIZO Corporation is under no obligation to hold any submitted material or information confidential unless prior arrangements are made pursuant to EIZO Corporation's receipt of said information. Although every effort has been made to ensure that this manual provides up-to-date information, please note that EIZO product specifications are subject to change without notice.

CONTENTS

1 Basic Adjustment / Settings	4
1.1 Switch Operation Method	4
1.2 Switching Input Signals	5
1.3 Switching Display Mode (CAL Switch Mode)	5
1.3.1 CAL Switch Modes	5
2 Advanced Adjustments/Settings	6
2.1 Basic Operation of the Setting Menu	6
2.2 Setting Menu Functions	7
2.2.1 CAL Switch Mode	7
2.2.2 RadiCS SelfQC	10
2.2.3 Preferences	14
2.2.4 Languages	17
2.2.5 Information	18
3 Administrator Settings	19
3.1 Basic Operation of the "Administrator Settings" Menu	19
3.2 Functions of the "Administrator Settings" Menu	19
4 Troubleshooting	22
4.1 No Picture	22
4.2 Imaging Problems	23
4.3 Other Problems	24
4.4 Error Code Table	25
5 Reference	26
5.1 Arm Installation Procedure	26
5.2 Using the Docking Station Function	27
5.3 Main Default Settings	29
5.3.1 CAL Switch Mode	29
5.3.2 Others	29
Appendix	31
Trademark	31
License	31
LIMITED WARRANTY	32

1 Basic Adjustment / Settings

This chapter describes the basic functions that can be adjusted and set using the switches on the front of the monitor.

For advanced adjustment and setting procedures using the Setting menu, see [2 Advanced Adjustments/Settings ▶ 6](#)].



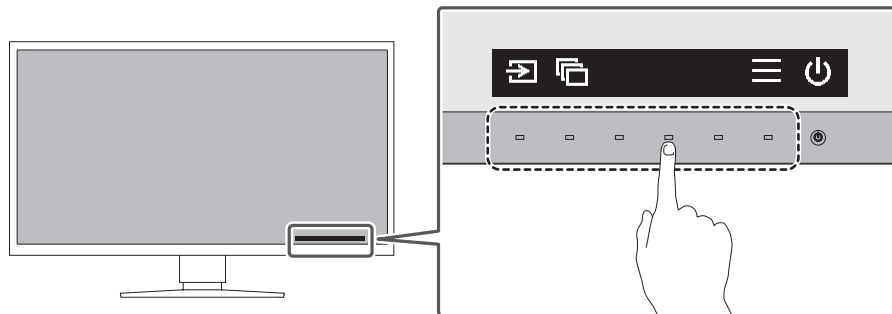

1.1 Switch Operation Method

1. Touch any switch (except ).
The operation guide appears on the screen.



Note

- Do not directly touch the operation guide that appears on the screen. There are switches below the operation guide that can be touched to perform adjustment/setting.

2. Touch a switch for adjustment/setting.
The Adjustment / Setting menu appears.
(A sub menu may also be displayed. In this case, select the item for adjustment/setting using   and select .)
3. Perform adjustment/setting with the switches and select  to accept the changes.
4. Select  to exit the menu.

1.2 Switching Input Signals

When a monitor has multiple signal inputs, the signal to display on-screen can be changed.

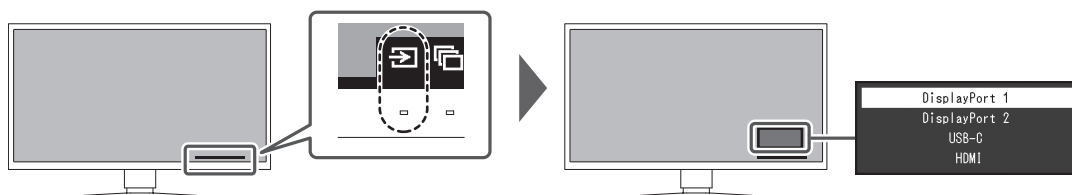

Selectable signals vary depending on [PbyP Settings - PbyP \[▶ 14\]](#) and [PbyP Settings - One Cable PbyP \[▶ 14\]](#).

		PbyP	
		Off	DisplayPort 1 DisplayPort 2
One Cable PbyP	Off	DisplayPort 1 DisplayPort 2 USB-C HDMI	DisplayPort 1 DisplayPort 2 USB-C HDMI
	DisplayPort 1	DisplayPort 1 (One Cable PbyP) DisplayPort 2 USB-C HDMI	-
	USB-C	DisplayPort 1 DisplayPort 2 USB-C (One Cable PbyP) HDMI	DisplayPort 1 DisplayPort 2 USB-C (One Cable PbyP) HDMI

1.3 Switching Display Mode (CAL Switch Mode)

The display mode can be selected according to the monitor application.

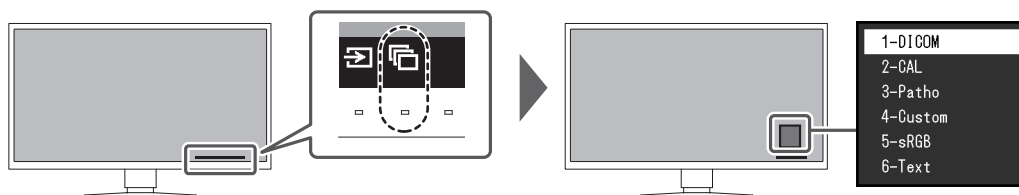

1.3.1 CAL Switch Modes

✓: Can be calibrated





Mode	Purpose	
1-DICOM	Enables display using DICOM® Part 14-compliant grayscale characteristics.	✓
2-CAL	Displays the calibration status using calibration software.	✓
3-Patho		✓
4-Custom	Select this mode to configure desired settings.	-
5-sRGB	Suitable for color matching with sRGB compatible peripherals.	-
6-Text	Suitable to display documents, spreadsheets, or other text.	-

2 Advanced Adjustments/Settings

This chapter describes the advanced monitor adjustment and setting procedures using the Setting menu.



For basic functions, see [1 Basic Adjustment / Settings](#) [▶ 4].

2.1 Basic Operation of the Setting Menu

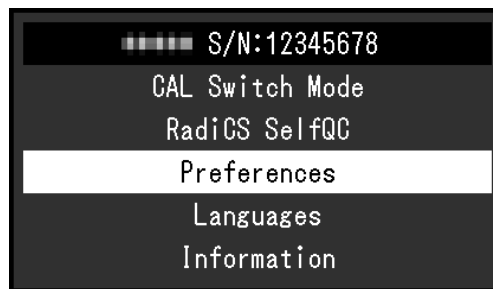
1. Touch any switch (except )
The operation guide appears.
2. Select 
The Setting menu appears.
3. Select a menu to adjust / set using  , then select .







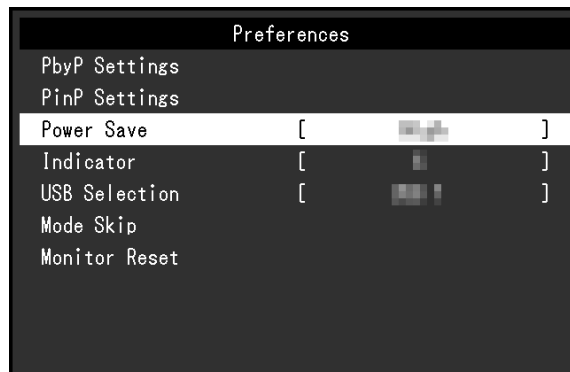

The Sub menu appears.

4. Select an item to adjust / set using  , then select .



The Adjustment / Setting menu appears.

5. Perform adjustment/setting with   or   and select  to accept the changes.
Selecting  during adjustment/setting will cancel the adjustment/setting and restore the state prior to making changes.

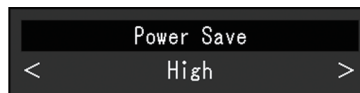

6. Selecting  several times will terminate the Setting menu.

2.2 Setting Menu Functions

2.2.1 CAL Switch Mode

The mode settings can be adjusted according to your preference. The adjusted settings are saved for each mode.

- DICOM / CAL / Patho

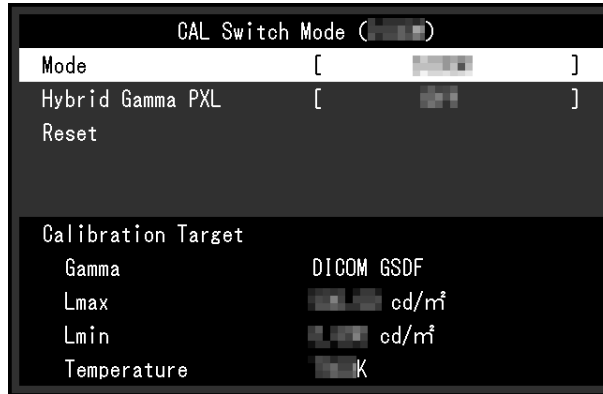

- Custom / sRGB / Text

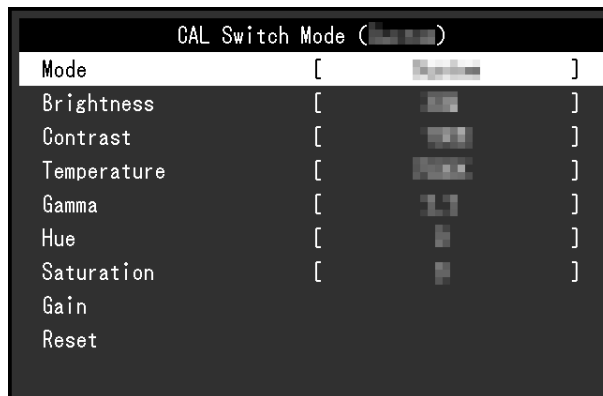

Functions that can be adjusted differ depending on the mode.

✓: Adjustable -: Not adjustable

Function	CAL Switch Mode					
	1-DICOM	2-CAL	3-Patho	4-Custom	5-sRGB	6-Text
Hybrid Gamma PXL	✓	✓	✓	-	-	-
Brightness	-	-	-	✓	✓	✓
Contrast	-	-	-	✓	✓	✓
Temperature	-	-	-	✓	✓	✓
Gamma	-	-	-	✓	✓	✓
Hue	-	-	-	✓	✓	✓
Saturation	-	-	-	✓	✓	✓
Gain	-	-	-	✓	✓	✓
Reset	✓	✓	✓	✓	✓	✓

Attention

- It takes about 15 minutes for the monitor display to stabilize. Please wait 15 minutes or more after the monitor power has been turned on or the monitor has recovered from power saving mode before making adjustments to it.
- The same image may be observed in different colors on multiple monitors due to monitor-specific characteristics. Make fine color adjustments visually when matching colors across multiple monitors. Follow the procedure below to adjust and match colors across multiple monitors.
 1. Display a white screen on each monitor.
 2. Use one of the monitors as a visual reference point to make adjustments to "Brightness", "Temperature", and "Gain" on the other monitors.

Note

- Use the values shown in "Brightness" and "Temperature" as a guide only.

Mode

Settings: "1-DICOM" / "2-CAL" / "3-Patho" / "4-Custom" / "5-sRGB" / "6-Text"

The display mode can be switched according to the intended use of the monitor.

The mode settings can also be adjusted according to your preference. Select the mode for adjustment and perform adjustment using the relevant functions.

Hybrid Gamma PXL

Settings: "On" / "Off"

When the Hybrid Gamma PXL function is enabled, this product automatically differentiates between monochrome and color parts of the same image at a pixel level, and displays a color image using the gamma value for color image display.

Brightness

Settings: "0%" – "100%"

You can adjust the screen brightness by changing the brightness of the backlight (light source from the LCD back panel).

Note

- If the image is too bright even when the brightness is set to 0 %, adjust the contrast.

Contrast

Settings: "0%" – "100%"

You can adjust the brightness of the screen by varying the video signal level.

Note

- When the contrast is set to 100 %, all the color gradations are shown.
- When adjusting the monitor, it is recommended to perform brightness adjustment, which does not lose gradation characteristics, prior to contrast adjustment.
- Perform contrast adjustment in the following cases.
 - If the screen is too bright even when the brightness is set to 0 %

Temperature

Settings: "Native" / "6000 K" to "15000 K"(in increments of 100 K) / "sRGB"

This function allows you to adjust the color temperature.

The color temperature is normally used to express the hue of "White" and/or "Black" with a numerical value. The value is expressed in degrees "K" (Kelvin).

The screen becomes reddish at low color temperatures and bluish at high color temperatures, similar to the temperatures of a flame. A gain preset value is set for each color temperature setting value.

Note

- Use the value shown in "K" as reference.
- "Gain" allows you to perform more advanced adjustment (See [Gain \[▶ 9\]](#)).
- If set to "Native", the image is displayed in the preset color of the LCD panel (Gain: 100% for each RGB channel).
- When the gain is changed, the color temperature setting changes to "User".

Gamma

Settings: "1.6" – "2.7" / "sRGB"

This function allows you to adjust the gamma. While the brightness of the monitor varies depending on the video level of the input signal, the variation rate is not directly proportional to the input signal. Maintaining the balance between the input signal and brightness of the monitor is referred to as "Gamma correction".

Hue

Settings: "-100" – "100"

This function allows you to adjust hue.

Attention

- Using this function may prevent some color gradations from being able to be displayed.

Saturation

Settings: "-100" – "100"

This function allows you to adjust color saturation.

Attention

- Using this function may prevent some color gradations from being able to be displayed.

Note

- The minimum value (-100) changes the screen to monochrome.

Gain

Settings: "0%" – "100%"

The brightness of each color component (red, green, and blue) is called "gain". The hue of "white" can be changed by adjusting the gain.

Attention

- Using this function may prevent some color gradations from being able to be displayed.

Note

- The gain value changes according to the color temperature.
- When the gain is changed, the color temperature setting changes to "User".

Reset

Resets any color adjustments for the currently selected mode back to the default settings.

2.2.2 RadiCS SelfQC

This product is equipped with an Integrated Front Sensor (calibration sensor). The Integrated Front Sensor enables you to perform quality control (calibration and Grayscale Check) on the monitor independently.



Note

- Calibration can be performed periodically by using the schedule function of RadiCS LE that is attached to the monitor. For more information about the setup procedure, refer to the RadiCS LE User's Manual (stored on the CD-ROM).
- RadiCS enables you to configure the schedule settings for Grayscale Check as well as for calibration. For more information about the setup procedure, refer to the RadiCS User's Manual.
- If you want to perform high-level quality control in compliance with medical standards / guidelines, use optional monitor quality control software kit "RadiCS UX2".
- To adjust measurement results of the integrated calibration sensor (Integrated Front Sensor) to those of an external sensor that is sold separately, perform correlation between the Integrated Front Sensor and the external sensor using RadiCS (optional accessory) / RadiCS LE (included). Periodical correlation allows you to maintain the measurement result of the Integrated Front Sensor at a level equivalent to that of the external sensor. For details on correlation, refer to the RadiCS / RadiCS LE User's Manual.

SelfCalibration

Execute SelfCalibration and view the latest results.

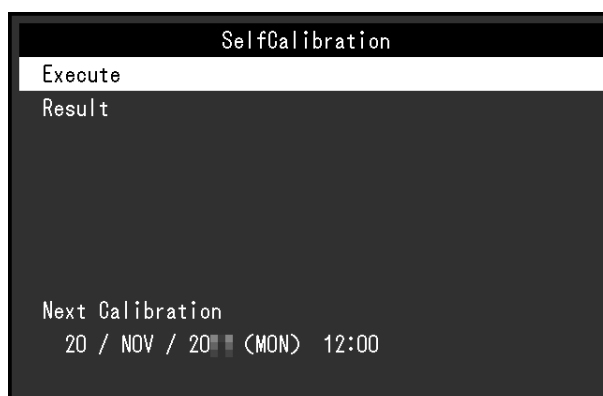

SelfCalibration - Execute

Executes SelfCalibration.

Attention

- If the power to the PC is turned off or the input signal switches while SelfCalibration is running, the execution will be canceled.
- After SelfCalibration is complete, perform Grayscale Check at the same room temperature and illuminance as those in the actual working environment.

Note

- The following items can be set by using RadiCS / RadiCS LE. For more information about the setup procedure, refer to RadiCS / RadiCS LE User's Manual.
 - Calibration target
 - SelfCalibration schedule
 - If you have configured the schedule using RadiCS / RadiCS LE, the next execution schedule is displayed.
- The calibration target value can be confirmed by selecting the target mode in "CAL Switch Mode" of the Setting menu.

SelfCalibration - Result

Settings: "DICOM" / "CAL" / "Patho"

The SelfCalibration execution results (such as Max. Error Rate, Last Time, and Error Code) for the selected mode are displayed.

Attention

- The results can be checked when "QC History" is set to "On" (see [Settings - Warning \[▶ 13\]](#), [Settings - QC History \[▶ 13\]](#)).

Grayscale Check

Perform Grayscale Check and view the latest results. Furthermore, if you have configured the schedule using RadiCS, the next execution schedule is displayed.

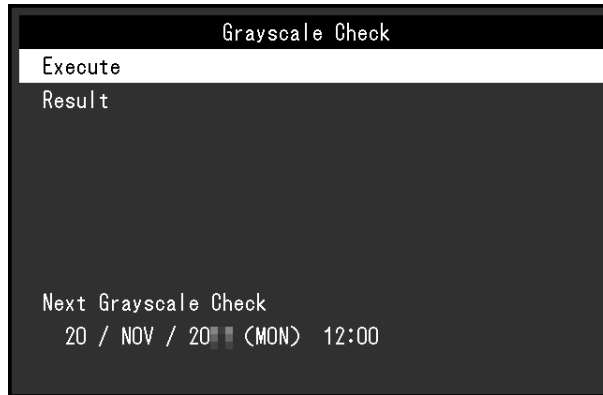

Grayscale Check - Execute

Executes Grayscale Check.

Attention
<ul style="list-style-type: none"> • Perform Grayscale Check based on the actual color temperature and brightness of the working environment.

Note
<ul style="list-style-type: none"> • The determination value for Grayscale Check can be specified from RadiCS. Refer to the RadiCS User's Manual for details. • The Grayscale Check schedule can be configured using RadiCS. For more information about the setup procedure, refer to the RadiCS User's Manual. If you have configured the schedule using RadiCS, the next execution schedule is displayed.

Grayscale Check - Result

Settings: "DICOM" / "CAL" / "Patho"

Up to five past execution results (Passed, Failed, Canceled, or Error) for the selected mode are displayed.

Attention
<ul style="list-style-type: none"> • The results can be checked when "QC History" is set to "On".

LEA

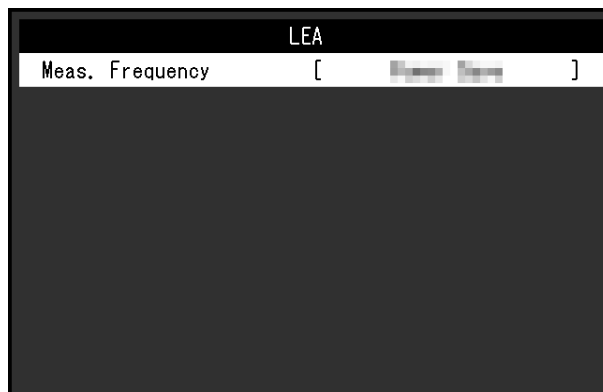

LEA - Meas. Frequency

Settings: "Power Save" / "Routine" / "Off"

You can acquire data required to estimate the monitor's lifespan. The life estimation result based on the acquired data can be confirmed using RadiCS / RadiCS LE.

Note

- Data is collected every 100 hours.
- If you selected "Power Save" and 100 hours have elapsed, the data collection process runs when the monitor enters the power saving mode or the power is turned off.
- If "Routine" or "Power Save" is selected, the Integrated Front Sensor starts measurement at the time of data collection. If "Off" is selected, measurement using the Integrated Front Sensor is not performed at the time of data collection.
- The collected data is saved at the following timings:
 - 500, 1000, 2000, 4000, 7000, 10000, 15000, 20000, 25000, and 30000 hours.

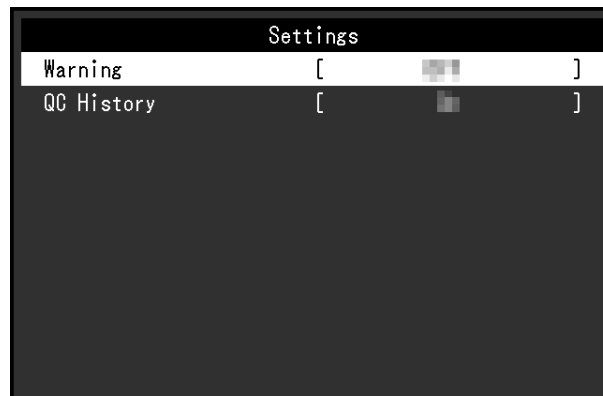
Settings**Settings - Warning**

Settings: "On" / "Off"

If this function is set to "On", a warning is displayed if the result of Grayscale Check is "Failed".

Settings - QC History

Settings: "On" / "Off"

If this function is set to "On", the execution results (QC history) of SelfCalibration and Grayscale Check are displayed.

2.2.3 Preferences

The monitor settings can be configured to suit the usage environment or your preference.

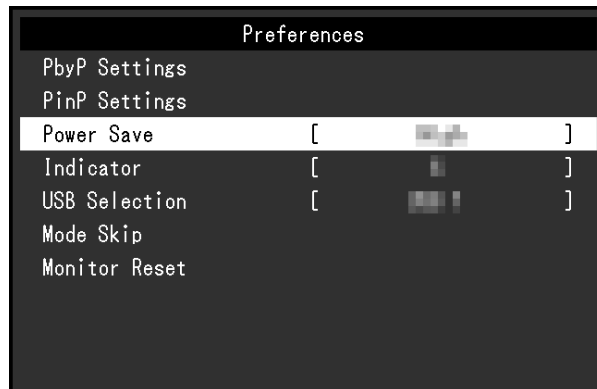

PbyP Settings

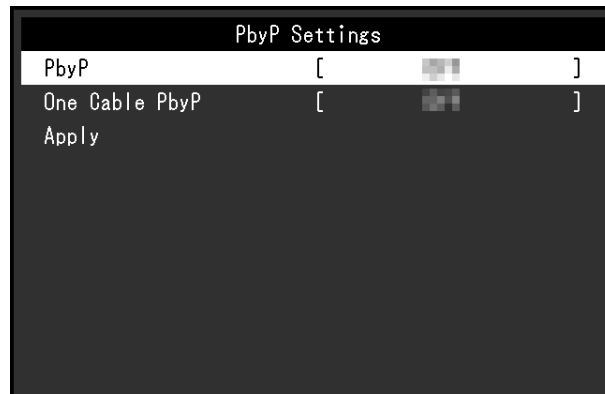

Display image

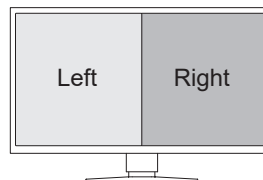

PbyP Settings - PbyP

Settings: "Off" / "DisplayPort 1 | DisplayPort 2"

Two different signals can be displayed side-by-side in PbyP display. If this function is set to "DisplayPort 1 | DisplayPort 2", the PbyP display, which displays the input signal "DisplayPort 1" on the left screen and "DisplayPort 2" on the right screen, can be selected as a switchable input signal (see [1.2 Switching Input Signals \[▶ 5\]](#)).

If the setting value is changed, the change is applied by selecting "Apply" in the "PbyP Settings" menu.

PbyP Settings - One Cable PbyP

Settings: "Off" / "DisplayPort 1" / "USB-C®"

A single input signal (one cable) can be used for PbyP display. If this function is set to "DisplayPort 1" or "USB-C", "DisplayPort 1 (One Cable PbyP)" or "USB-C (One Cable PbyP)" can be selected as switchable input signals (see [1.2 Switching Input Signals \[▶ 5\]](#)).

If the setting value is changed, the change is applied by selecting "Apply" in the "PbyP Settings" menu.

PinP Settings

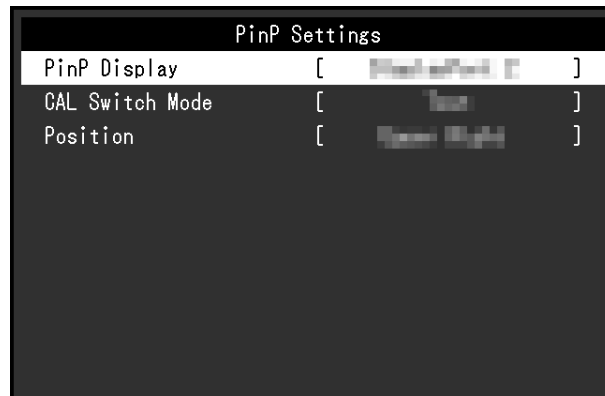

Display image

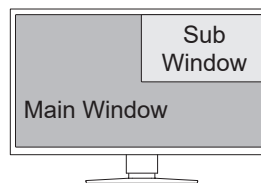



PinP Settings - PinP

Settings: "Off" / "DisplayPort 2" / "USB-C" / "HDMI"

Selects the input signal for the PinP sub window to be displayed on the screen. If this function is set to "Off", the PinP sub window will not be displayed.

Note

- When an HDMI signal is displayed in single screen mode, this function cannot be used (displayed in gray text).
- The display for the signal input to the PinP sub window is enlarged. For this reason, it is not suitable for displaying medical images.
- If this function is set to anything other than "Off",  is displayed in the operation guide. Touch the operation switch () to toggle between displaying and hiding the PinP sub window.
- By using RadiCS / RadiCS LE, you can display or hide the PinP sub window more easily using the mouse or keyboard (Hide-and-Seek). Refer to RadiCS / RadiCS LE User's Manual for details.

PinP Settings - CAL Switch Mode

Settings: "DICOM" / "CAL" / "Patho" / "Custom" / "sRGB" / "Text"

You can select the display mode of the PinP sub window.

PinP Settings - Position

Settings: "Upper Right" / "Lower Right" / "Lower Left" / "Upper Left"

You can select the display position of the PinP sub window.

Power Save

Settings: "High" / "Low" / "Off"

You can specify whether the monitor enters the power saving mode according to the PC status.

- High
Turns the backlight off. This provides the highest power saving effect.
- Low
Sets the backlight to the lowest lighting level. The time until operation stabilizes after restoring from power saving mode can be reduced.
- Off
Does not enable the power saving mode. The backlight lights up irrespective of the PC status. This setting may shorten the backlight life.

Note

- When not using the monitor, you can turn off the main power supply or disconnect the power plug so that the power is cut completely.
- Devices connected to the USB upstream port and downstream port still work when the monitor is in the power saving mode or when the power is switched off using the power button () of the monitor. For this reason, power consumption of the monitor varies with connected devices even in the power saving mode.
- When the signal input from the PC is no longer detected, a message appears notifying the user of the transition to power saving mode. The monitor enters power saving mode five seconds after the message appears.
- When power save is set to "High" or "Low", the status of the monitor can be confirmed by checking the color of the indicator on the power switch.
 - Power indicator is green: Monitor is in normal operation mode
 - Power indicator is orange: Monitor is in power saving mode

Indicator











Settings: "1" – "7" / "Off"

The brightness of the power switch indicator (green) while the screen is displayed can be adjusted. The larger the set value, the brighter the power indicator lights up. On the other hand, the smaller the value, the darker it becomes. The "Off" setting turns off the power switch indicator.





USB Selection

Settings: "USB 1" / "USB-C" / "USB 1 - USB 2" / "USB 1 - USB-C"

You can select the PC that controls the USB peripherals such as a mouse and keyboard connected to the USB downstream port of the monitor.

- "USB 1"
The PC connected to USB-B 1 () is selected.
- "USB-C"
The PC connected to USB-C (upstream: ) is selected.
- "USB 1 - USB 2"
Set to manually switch whether the PC connected to USB-B 1 () or the PC connected to USB-B 2 () uses the USB peripheral device. If this is set,  is displayed in the operation guide. Touch the displayed operation switch () and select "USB 1" or "USB 2".
- "USB 1 - USB-C"
Set to manually switch whether the PC connected to USB-B 1 () or the PC connected to USB-C (upstream: ) uses the USB peripheral device. If this is set,  is displayed in the operation guide. Touch the displayed operation switch () and select "USB 1" or "USB-C".

Note

- Switching the USB upstream port will temporarily disconnect the USB signal. If a storage device such as a USB memory stick is connected to the monitor, switch the port only after you have removed the storage device.
- If the [Ethernet \[▶ 20\]](#) setting is "On", "USB 1 - USB 2" cannot be selected.
- Connect PCs that will perform monitor quality control to USB-B 1 () or USB-C (upstream: ).
- USB-C (downstream: ) works as follows, regardless of the USB selection setting.
 - If [Daisy Chain - Output \[▶ 21\]](#) is "On" and [Daisy Chain - Input \[▶ 21\]](#) is "DisplayPort 1", it links with the PC connected to USB-B 1 ()
 - If [Daisy Chain - Output \[▶ 21\]](#) is "On" and [Daisy Chain - Input \[▶ 21\]](#) is "USB-C", it links with the PC connected to USB-C (upstream: )

Mode Skip

This function allows you to skip certain display modes when selecting a mode.

Please use this function if you want to limit the modes to be displayed, or avoid changing the display status randomly.

Attention

- Not all modes can be disabled (skipped). Set at least one mode to "-".

All Reset

Restores all settings to their default settings except for the following settings:

- "PbyP Settings" settings
- "PinP Settings" settings
- Settings on the "Administrator Settings" menu

Attention

- The previous settings cannot be recovered after they were reset to defaults.

Note

- For details on default settings, see [5.3 Main Default Settings \[▶ 29\]](#).

2.2.4 Languages

Settings: "English" / "German" / "French" / "Spanish" / "Italian" / "Swedish" / "Japanese" / "Simplified Chinese" / "Traditional Chinese"

The display language for menus and messages can be selected.



2.2.5 Information

You can check the monitor information (model name, serial number (S/N), firmware version, usage time) and the input signal information.

The asset tag number is only displayed when it has been set using RadiCS / RadiCS LE.

Example:

- Single screen display

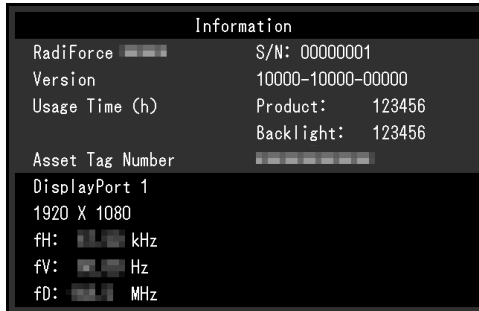

- PbyP / PinP display

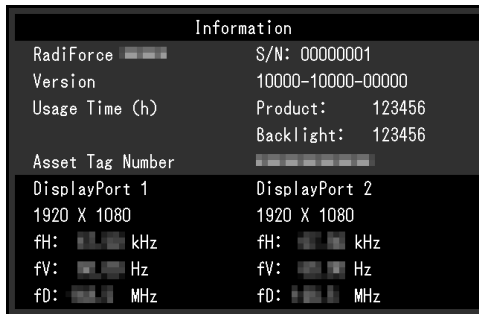

- PbyP + PinP display

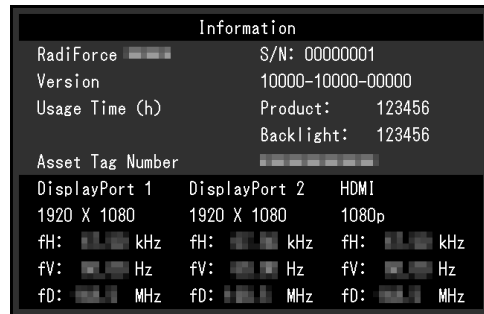







Attention

- The usage time may not be "0" at the time of your purchase because inspections and other processes had been carried out on the monitor before it was shipped from the factory.

3 Administrator Settings

This chapter describes how to configure monitor operation using the "Administrator Settings" menu.

3.1 Basic Operation of the "Administrator Settings" Menu

1. Touch  to turn off the monitor.
2. While touching the leftmost switch () , touch  for more than two seconds to turn on the monitor.
The "Administrator Settings" menu appears.
3. Select an item to set with   and select .

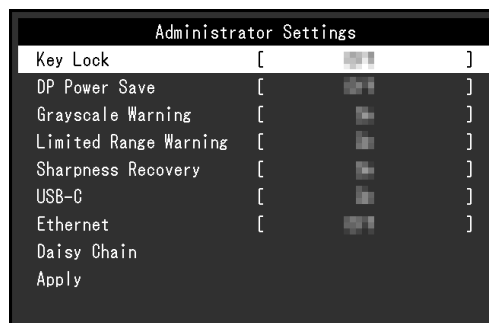

The Adjustment / Setting menu appears.

4. Perform adjustment/setting with   or   and select .



5. In the "Administrator Settings" menu, select "Apply", and then select .
The settings are applied and the "Administrator Settings" menu exits.

3.2 Functions of the "Administrator Settings" Menu

Key Lock

Settings: "Off" / "Menu" / "All"

In order to prevent changes to settings, the operation switches on the front of the monitor can be locked.

- "Off"
Enables all switches.
- "Menu"
Locks the  switch.
- "All"
Locks all switches except the power switch.

Note

- After calibration is performed using RadiCS / RadiCS LE, "Menu" is selected.

DP Power Save

Settings: "On" / "Off"

Connecting a PC to the DisplayPort connector enables DisplayPort communication, and thus consumes high power even in the power saving mode. The communication can be disabled by setting "DP Power Save" to "On". This reduces power consumption in the power saving mode (the default setting is Off).

Attention

- If "On" is selected, window and icon positions may shift when the monitor is powered back on or returned from the power saving mode. In such cases, set this function to "Off".

Grayscale Warning

Settings: "On" / "Off"

You can specify whether to display the Grayscale Display Error message to indicate that a 6-bit (64-grayscale) signal has been detected when the DisplayPort signal or USB-C signal is input at the recommended resolution. If the error message appears, please turn off the main power, and then turn it on again.

Attention

- Always use with this set to "On" (the default setting is "On").
- Set this to "Off" only when using 6-bit (64 grayscale) display.

Limited Range Warning

Settings: "On" / "Off"

Sets whether or not to display a warning message when a limited range HDMI input signal is detected. If a warning message appears, change the input signal to full range.

Sharpness Recovery

Settings: "On" / "Off"

EIZO's unique technology called "Sharpness Recovery" improves picture clarity and displays images that are true to the original source data.

Attention

- After changing the setting, perform a visual check according to the medical standards / guidelines.

USB-C

Settings: "On" / "Off"

Sets whether or not to display the USB-C input signal as a switchable signal when switching the input signal with  in the operation guide.

Ethernet

Settings: "On" / "Off"

You can switch between enabling and disabling of the LAN port of the monitor.

- "On"
Enables the LAN port and allows network connections from PCs connected with USB-C.

- "Off"
Disables the LAN port.

Note

- If this is set to "On", it will automatically change to "USB 1" if [USB Selection \[▶ 16\]](#) is set to "USB 1 - USB 2".

Daisy Chain**Daisy Chain - Output**

Settings: "On" / "Off"

If this function is set to "On", it will enable a daisy-chain connection from the USB-C connector (downstream: ) of this product to another monitor.



Note

- Even if this setting is set to "Off", power can still be supplied to devices connected to the USB-C connector (downstream: ) .

Daisy Chain - Input

Settings: "DisplayPort 1" / "USB-C"

Sets the signal output from the USB-C connector (downstream: ) when the daisy chain connection is enabled.

- "DisplayPort 1"
Outputs the signal input to the DisplayPort1 connector () .
- "USB-C"
Outputs the signal input to the USB-C connector (upstream: ) .

4 Troubleshooting

4.1 No Picture

Power switch indicator does not light up

- Check whether the power cord is connected properly.
- Turn on the main power switch on the back of the monitor.
- Touch .
- Turn off the main power switch on the back of the monitor, and then turn it on again a few minutes later.

Power switch indicator lights up: Green

- Increase "Brightness", "Contrast", or "Gain" in the Setting menu (see [CAL Switch Mode](#) [▶ 7](#)).
- Turn off the main power switch on the back of the monitor, and then turn it on again a few minutes later.

Power switch indicator lights up: Orange

- Try switching the input signal (see [1.2 Switching Input Signals](#) [▶ 5](#)).
- Move the mouse or press any key on the keyboard.
- Check whether the PC is turned on.
- Check whether the signal cable is connected properly. Connect the signal cables to the connectors of the corresponding input signal.
- Turn off the main power switch on the back of the monitor, and then turn it on again.

Power switch indicator blinks: Orange, Green

- Connect using a signal cable specified by EIZO. Then turn off the main power switch on the back of the monitor, and then turn it on again a few minutes later.

The message "No Signal" appears on the screen.

Example:

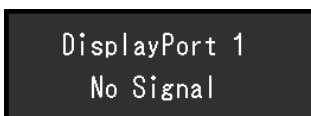

- The message shown above may appear as some PCs do not output a signal immediately after power-on.
- Check whether the PC is turned on.
- Check whether the signal cable is connected properly. Connect the signal cables to the connectors of the corresponding input signal.
- USB-C (downstream: ) is used for the daisy-chain connection output. The screen is not displayed even when connected to a PC.
- Try switching the input signal (see [1.2 Switching Input Signals](#) [▶ 5](#)).
- Turn off the main power switch on the back of the monitor, and then turn it on again.

The message "Signal Error" appears on the screen.

Example:

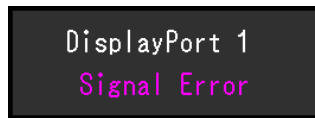

- Check whether the PC is configured to meet the resolution and vertical scan frequency requirements of the monitor (see "Compatible Resolutions" in the Instructions for Use).
- Reboot the PC.
- Select an appropriate setting using the graphics board's utility. Refer to the User's Manual of the graphics board for details.

The message "DP Unsupported" appears on the screen

- Check whether the connected cable is a signal cable recommended by EIZO.
- Check whether the USB-C of the connected device supports video signal output (DisplayPort Alt Mode). For details, contact the manufacturer of the device.
- Connect a DisplayPort cable or an HDMI cable.

4.2 Imaging Problems

The screen is too bright or too dark

- Use "Brightness" or "Contrast" in the Setting menu to adjust it (see [CAL Switch Mode \[▶ 7\]](#)). The LCD monitor backlight has a limited life span. When the screen becomes dark or begins to flicker, contact your local EIZO representative.

Text is blurred

- Check whether the PC is configured to meet the resolution and vertical scan frequency requirements of the monitor (see "Compatible Resolutions" in the Instructions for Use).
- Try setting the magnification of display on the OS to "100 %". When using multiple monitors, try setting the magnification of display to "100 %" on all monitors.

An afterimage can be seen

- Afterimages are particular to LCD monitors. Avoid displaying the same image for a long time.
- Use the screen saver or power save function if you are going to be displaying the same image for extended periods of time.
- An afterimage may appear even after a short time period has elapsed depending on the displayed image. To remove such a phenomenon, change the image or keep the power turned off for several hours.

Green, red, blue, or white dots remain on the screen / Some dots do not light up

- This is common with LCD panels, and is not a malfunction.

Interference patterns or pressure marks remain on the LCD panel

- Leave the monitor with a white or black screen. The symptom may disappear.

The screen is split into two views.

- In the Setting menu, set "One Cable PbyP" to "Off" (see [PbyP Settings - One Cable PbyP \[▶ 14\]](#)).
- In the Setting menu, set "PbyP" to "Off" (see [PbyP Settings - PbyP \[▶ 14\]](#)).

4.3 Other Problems

The Setting menu does not appear

- Check whether the operation switch lock function is active (see [Key Lock \[▶ 19\]](#)).

The Mode menu does not appear

- Check whether the operation switch lock function is active (see [Key Lock \[▶ 19\]](#)).

The operation switches do not work

- Check whether the operation switch lock function is active (see [Key Lock \[▶ 19\]](#)).
- Check whether there are any water droplets or foreign objects on the switch surface. Gently wipe the switch surface and try operating the switches again with dry hands.
- Are you wearing gloves? If so, remove the gloves and try operating the switches again with dry hands.

USB peripheral devices connected to the monitor do not work / Cannot use the Docking Station Function

- Check whether the USB cable is correctly connected between the PC and the USB upstream port on the monitor.
- When two PCs are connected to one monitor, check whether the correct USB upstream port is enabled (see [USB Selection \[▶ 16\]](#)).
- Check whether the peripheral device is correctly connected to the USB downstream port on the monitor.
- Try using a different USB downstream port on the monitor.
- Try using a different USB port on the PC.
- Check whether the device drivers of the peripheral devices are up-to-date.
- Reboot the PC.
- Set "USB-C" to "On" (see [USB-C \[▶ 20\]](#)).
- In the following cases, the LAN port cannot be used.
 - When "Ethernet" is set to "Off" in the "Administrator Settings" menu. Set "Ethernet" to "On" (see [Ethernet \[▶ 20\]](#)).
 - When a USB-C connection is not used.
 - When the operating system of the PC is not supported (see "Network" in the Instructions for Use).
- If the peripheral devices work correctly when they are directly connected to the PC, contact your local EIZO representative.
- Check the PC's BIOS (UEFI) setting for USB when using Windows. (See the manual of the PC for details.)

- Check if the operating system of the PC is up-to-date.
- If you are using macOS Ventura (13), select "Allow" in the "Allow accessory to connect?" message window that appears when connecting via USB.

The monitor does not supply power (USB Power Delivery) to the PC.

- Check whether the PC has the specifications to operate with a 94 W power supply.
- For a 94 W power supply, use the following USB cables:
 - CC150SS81G-5A (Included)

The Integrated Front Sensor stays out.

- Turn off the main power, and then turn it on again.

RadiCS fails to connect to the monitor

- Check that the USB cable is not pulled out.
- Check the [USB Selection \[▶ 16\]](#) setting. The USB connector connected to the computer on which RadiCS is installed must be enabled.

SelfCalibration / Grayscale Check fails.

- Refer to [4.4 Error Code Table \[▶ 25\]](#).
- If an error code that does not appear in the error code table is displayed, contact your dealer or local EIZO representative.

Attention
<ul style="list-style-type: none"> • Do not touch the Integrated Front Sensor.

The SelfCalibration / Grayscale Check history does not display the clock time correctly.

- Perform monitor detection using RadiCS / RadiCS LE. For details, refer to the RadiCS / RadiCS LE User's Manual.

4.4 Error Code Table

Error Code	Description
****50	<ul style="list-style-type: none"> • The maximum brightness of the monitor may be lower than the target brightness. • Try reducing the target brightness.
****52	<ul style="list-style-type: none"> • The minimum brightness of the monitor may be higher than the target minimum brightness. • Try increasing the target minimum brightness.
****05	<ul style="list-style-type: none"> • The sensor may not have worked correctly. • Turn off the main power, wait for a few minutes, turn the power back on, and then run SelfCalibration / Grayscale Check again.
****20 ****21	<ul style="list-style-type: none"> • The sensor may not have worked correctly. • Check whether there is any foreign object near the sensor. • Run SelfCalibration / Grayscale Check again.

5 Reference

5.1 Arm Installation Procedure

A third-party monitor arm (or stand) can be attached by removing the stand of this product.

When attaching an arm or stand, the installable orientations and movement range (tilt angle) are as follows.

- Orientation



- Movement range (tilt angle)

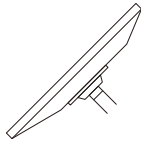

Up: 45°

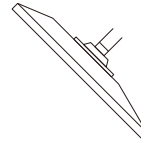

Down: 45°

Attention

- When attaching an arm or stand, follow the instructions of the respective User's Manual.
- When using a third-party arm or stand, confirm the following in advance and select one that conforms to the VESA standard.
 - Clearance between the screw holes: 100 mm x 100 mm
 - Arm/stand VESA mount dimensions: 122 mm x 122 mm or less
 - Strong enough to support weight of the monitor unit (excluding the stand) and attachments such as cables
- When using another manufacturer's arm or stand, use the following screws to secure it.
 - Screws fixing the stand to the monitor
- Connect the cables after attaching an arm or stand.
- Do not move the removed stand up and down. Doing so may result in injury or device damage.
- The monitor, arm, and stand are heavy. Dropping them may result in injury or equipment damage.
- Periodically check the tightness of the screws. If not sufficiently tight, the monitor may detach from the arm, which may result in injury or equipment damage.

1. In order to prevent the LCD panel surface from being scratched, lay the monitor on a soft cloth spread on a stable surface with the LCD panel surface facing down.
2. Prepare a screwdriver. Using a screwdriver, remove the screws (four) securing the unit and the stand.

3. Use the screws that you removed in step 2 to attach the arm (or stand) to the monitor.

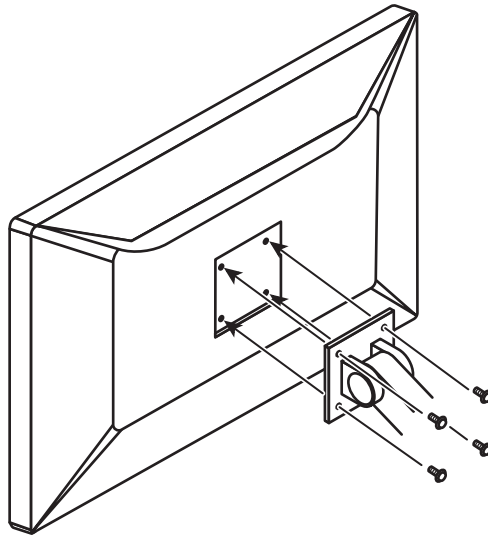

5.2 Using the Docking Station Function

This monitor is equipped with a LAN port and USB hub that enables it to be used as a docking station. By connecting a USB-C cable, you can create a stable network environment even on notebook PCs or tablet devices that are not equipped with LAN ports. In addition, peripheral devices that support USB can be used, and smartphones can be charged.

1. Connect a USB-C cable (CC150SS81G-5A).
2. Set [Ethernet \[▶ 20\]](#) to "On" and [USB Selection \[▶ 16\]](#) to "USB-C" or "USB 1 - USB-C".
3. Connect the LAN cable to the monitor's LAN port.

4. If necessary, connect a mouse, keyboard, or other device to the USB downstream port.

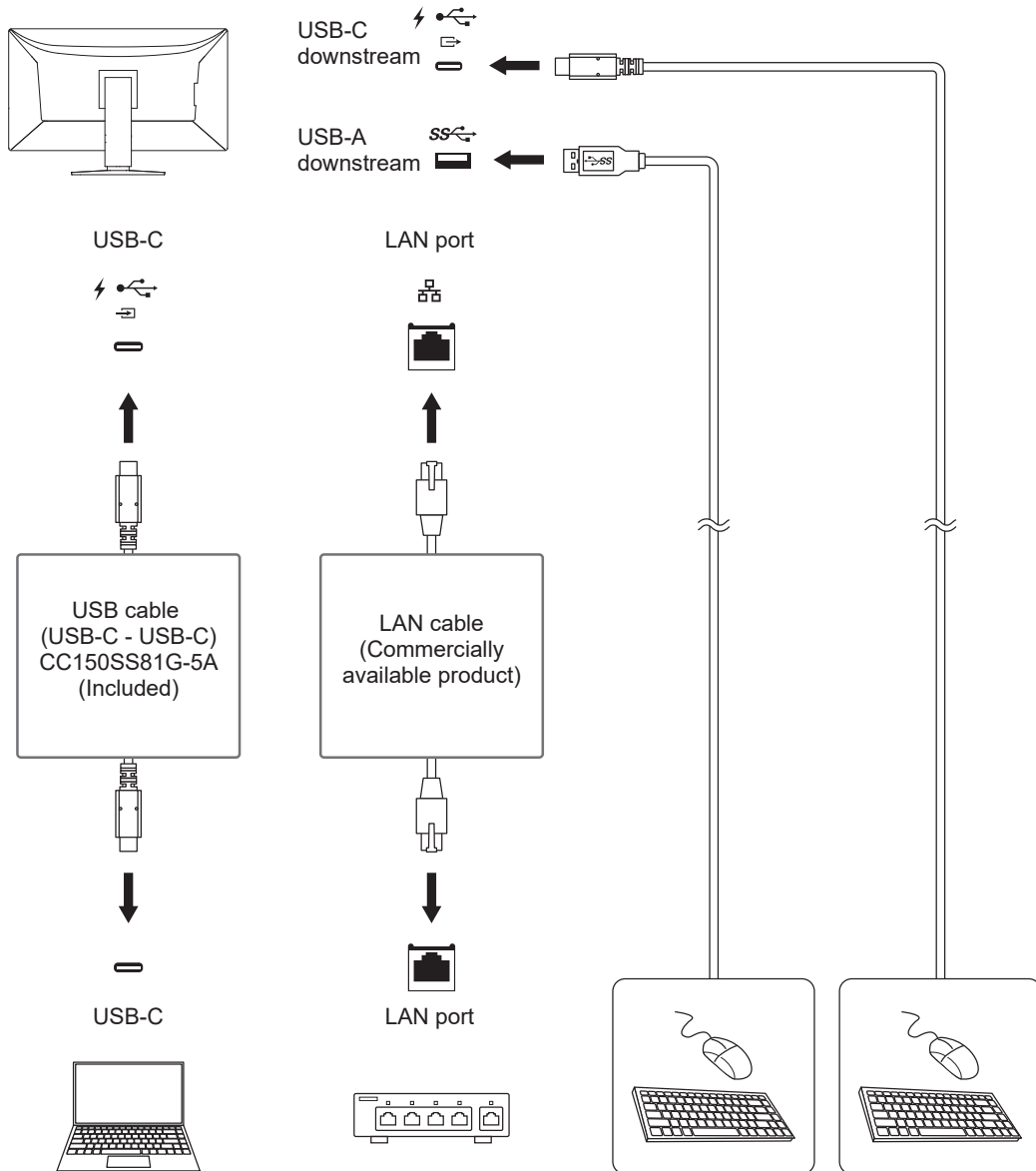

Attention

- This function may not work depending on the PC you are using, your OS, and your peripheral devices. Contact the manufacturer of each device for information about USB compatibility.
- Even when the monitor is in power saving mode, devices connected to the USB downstream port are operational. Therefore, power consumption of the monitor varies depending on the connected devices, even in the power saving mode.
- When the main power switch of the monitor is off, a device connected to the USB downstream port will not operate.

Note

- In the factory settings, a cap is placed over the LAN port. Remove the cap when using.
- The transfer speed of the LAN port depends on the USB transfer speed. The maximum USB transfer speed of this product is 480 Mbps.
- The MAC address can be found on the back of the monitor. MAC address pass-through is not supported.
- By using RadiCS / RadiCS LE, you can replace the MAC address of the monitor with another MAC address that is authorized to access the network. For details, refer to the RadiCS / RadiCS LE User's Manual.
- For USB-B connection, the LAN port cannot be used, but the USB hub function works. Peripheral devices that support USB can be used and smartphones can be charged.

5.3 Main Default Settings

5.3.1 CAL Switch Mode

Factory default display setting is "1-DICOM".

Mode	Brightness	Temperature	Gamma	Hybrid Gamma PXL
1-DICOM	270 cd/m ²	7500 K	DICOM GSDF	Off
2-CAL	370 cd/m ²	6500 K	DICOM GSDF	Off
3-Patho	370 cd/m ²	6500 K	2.2	Off
4-Custom	Approx. 180 cd/m ²	7500 K	2.2	- (Disable)
5-sRGB	Approx. 180 cd/m ²	sRGB	sRGB	- (Disable)
6-Text	Approx. 100 cd/m ²	6500 K	2.2	- (Disable)

5.3.2 Others

LEA - Meas. Frequency	Power Save
Settings - Warning	Off
Settings - QC History	On
PbyP Settings - PbyP	Off ¹
PbyP Settings - One Cable PbyP	Off ¹
PinP Settings - PinP Display	Off ¹
PinP Settings - CAL Switch Mode	DICOM
PinP Settings - Position	Upper Right
Power Save	High
Indicator	4
USB Selection	USB 1
Mode Skip	- (Display all)
Languages	English
Key Lock	Off ¹
DP Power Save	Off ¹
Grayscale Warning	On ¹
Limited Range Warning	On ¹
Sharpness Recovery	On ¹
USB-C	On ¹
Ethernet	Off ¹
Daisy Chain - Output	Off ¹

Daisy Chain - Input	DisplayPort 1 ^{*1}
---------------------	-----------------------------

*1 These menus cannot be initialized by executing "Monitor Reset" (see [All Reset \[▶ 17\]](#)).

Appendix

Trademark

The terms HDMI, HDMI High-Definition Multimedia Interface, HDMI trade dress and the HDMI Logos are trademarks or registered trademarks of HDMI Licensing Administrator, Inc. DisplayPort, the DisplayPort Compliance Logo and VESA are trademarks of the Video Electronics Standards Association in the United States and other countries.

The SuperSpeed USB Trident Logo is a registered trademark of USB Implementers Forum, Inc.



The SuperSpeed USB Power Delivery Trident Logos are trademarks of USB Implementers Forum, Inc.



USB Type-C and USB-C are registered trademarks of USB Implementers Forum, Inc.

DICOM is the registered trademark of the National Electrical Manufacturers Association for its standards publications relating to digital communications of medical information.

Kensington and Microsaver are registered trademarks of ACCO Brands Corporation.

Thunderbolt is a trademark of Intel Corporation in the United States and/or other countries.

Microsoft and Windows are registered trademarks of Microsoft Corporation in the United States and other countries.

Adobe is a registered trademark of Adobe in the United States and other countries.

Apple, macOS, Mac OS, OS X, macOS Sierra, Macintosh and ColorSync are trademarks of Apple Inc.

ENERGY STAR is a registered trademark of the United States Environmental Protection Agency in the United States and other countries.

EIZO, the EIZO Logo, ColorEdge, CuratOR, DuraVision, FlexScan, FORIS, RadiCS, RadiForce, RadiNET, Raptor, and ScreenManager are registered trademarks of EIZO Corporation in Japan and other countries.

ColorEdge Tablet Controller, ColorNavigator, EcoView NET, EIZO EasyPIX, EIZO Monitor Configurator, EIZO ScreenSlicer, G-Ignition, i•Sound, Quick Color Match, RadiLight, Re/Vue, SafeGuard, Screen Administrator, Screen InStyle, ScreenCleaner, SwitchLink, and UniColor Pro are trademarks of EIZO Corporation.

All other company names, product names, and logos are trademarks or registered trademarks of their respective owners.

License

This product contains open source software. If open source software that is licensed under the terms of the GPL (GNU GENERAL PUBLIC LICENSE) is included, we will distribute the source code corresponding to the GPL software on a CD-ROM or other medium at actual cost for at least three years after purchase to any individual or organization that contacts us at the contact information below, in accordance with the terms of the GPL license. In addition, if the source code includes material licensed under the terms of the LGPL (GNU LESSER GENERAL PUBLIC LICENSE), the source code will be distributed in the same manner as the GPL described above.

Contact information: www.eizoglobal.com/contact/index.html

*Contact your local EIZO representative.

Except for open source software licensed under GPL/LGPL or otherwise, the software contained in this product may not be transferred, copied, disassembled, decompiled, or reverse engineered. In addition, export of any software contained in this product in violation of export laws and regulations is prohibited.

The bitmap font used for this product is designed by Ricoh Industrial Solutions Inc.

LIMITED WARRANTY

EIZO Corporation (hereinafter referred to as "EIZO") and distributors authorized by EIZO (hereinafter referred to as the "Distributors") warrant, subject to and in accordance with the terms of this limited warranty (hereinafter referred to as the "Warranty"), to the original purchaser (hereinafter referred to as the "Original Purchaser") who purchased the product specified in this document (hereinafter referred to as the "Product") from EIZO or Distributors, that EIZO and Distributors shall, at their sole discretion, either repair or replace the Product at no charge if the Original Purchaser becomes aware within the Warranty Period (defined below) that (i) the Product malfunctions or is damaged in the course of normal use of the Product in accordance with the description in the instruction manual of the Product (hereinafter referred to as the "User's Manual"), or (ii) the LCD panel and brightness of the Product cannot maintain the recommended brightness specified in the User's Manual in the course of normal use of the Product in accordance with the description of the User's Manual.

The period of this Warranty is five (5) years from the date of purchase of the Product (hereinafter referred to as the "Warranty Period").

However, the brightness of the Product shall be warranted only if the Product has been used within the recommended brightness described in the User's Manual.

The Warranty Period for the brightness is also limited to five (5) years from the date of purchase of the Product subject to the usage time being less than or equal to 15,000 hours (the brightness is 270 cd/m² and color temperature is 7500K).

EIZO and Distributors shall bear no liability or obligation with regard to the Product in relation to the Original Purchaser or any third parties other than as provided under this Warranty.

EIZO and Distributors will cease to hold or store any parts (excluding design parts) of the Product upon expiration of seven (7) years after the production of the Product is discontinued.

In repairing the Product, EIZO and Distributors will use renewal parts which comply with our QC standards. If the unit cannot be repaired due to its condition or the stockout of a relevant part, EIZO and Distributors may offer the replacement by a product with equivalent performance instead of repairing it.

The Warranty is valid only in the countries or territories where the Distributors are located. The Warranty does not restrict any legal rights of the Original Purchaser.

Notwithstanding any other provision of this Warranty, EIZO and Distributors shall have no obligation under this Warranty whatsoever in any of the cases as set forth below:

1. Any defect of the Product caused by freight damage, modification, alteration, abuse, misuse, accident, incorrect installation, disaster, adherent dust, faulty maintenance and/or improper repair by third party other than EIZO and Distributors;
2. Any incompatibility of the Product due to possible technical innovations and/or regulations;
3. Any deterioration of the sensor, including measurement value of the sensor;
4. Any defect of the Product caused by external equipments;
5. Any defect of the Product caused by the use under environmental conditions not anticipated by EIZO;

6. Any deterioration of the attachments of the Product (e.g. cables, User's Manual, CD-ROM, etc.);
7. Any deterioration of the consumables, and/or accessories of the Product (e.g. batteries, remote controller, touch pen, etc.);
8. Any exterior deterioration or discoloration of the Product, including that of the surface of the LCD panel, the touch panel and the protect panel;
9. Any defect of the Product caused by placement in a location where it may be affected by strong vibrations or shocks;
10. Any defect of the Product caused by leaking battery liquid;
11. Any deterioration of the Product caused by the use at higher brightness than the recommended brightness described in the User's Manual;
12. Any deterioration of display performance caused by the deterioration of expendable parts such as the LCD panel and/or backlight, etc. (e.g. changes in brightness uniformity, changes in color, changes in color uniformity, defects in pixels including burnt pixels, etc.);
13. Any deterioration or malfunction of the cooling fan caused by adherent dust.

To obtain service under the Warranty, the Original Purchaser must deliver the Product, freight prepaid, in its original package or other adequate package affording an equal degree of protection, assuming the risk of damage and/or loss in transit, to the local Distributor. The Original Purchaser must present proof of purchase of the Product and the date of such purchase when requesting services under the Warranty.

The Warranty Period for any replaced and/or repaired product under this Warranty shall expire at the end of the original Warranty Period.

EIZO OR DISTRIBUTORS ARE NOT RESPONSIBLE FOR ANY DAMAGE TO, OR LOSS OF, DATA OR OTHER INFORMATION STORED IN ANY MEDIA OR ANY PART OF ANY PRODUCT RETURNED TO EIZO OR DISTRIBUTORS FOR REPAIR.

EIZO AND DISTRIBUTORS MAKE NO FURTHER WARRANTIES, EXPRESSED OR IMPLIED, WITH RESPECT TO, INCLUDING, WITHOUT LIMITATION, THE PRODUCT AND ITS QUALITY, PERFORMANCE, MERCHANTABILITY OR FITNESS FOR ANY PARTICULAR USE.

IN NO EVENT SHALL EIZO OR DISTRIBUTORS BE LIABLE FOR ANY INCIDENTAL, INDIRECT, SPECIAL, CONSEQUENTIAL OR OTHER DAMAGE WHATSOEVER (INCLUDING, WITHOUT LIMITATION, DAMAGES FOR LOSS OF PROFIT, BUSINESS INTERRUPTION, LOSS OF BUSINESS INFORMATION, OR ANY OTHER PECUNIARY LOSS) ARISING OUT OF THE USE OR INABILITY TO USE THE PRODUCT OR IN ANY CONNECTION WITH THE PRODUCT, WHETHER BASED ON CONTRACT, TORT, NEGLIGENCE, STRICT LIABILITY OR OTHERWISE, EVEN IF EIZO OR DISTRIBUTORS HAVE BEEN ADVISED OF THE POSSIBILITY OF SUCH DAMAGES.

THIS EXCLUSION ALSO INCLUDES ANY LIABILITY WHICH MAY ARISE OUT OF THIRD PARTY CLAIMS AGAINST THE ORIGINAL PURCHASER. THE ESSENCE OF THIS PROVISION IS TO LIMIT THE POTENTIAL LIABILITY OF EIZO AND DISTRIBUTORS ARISING OUT OF THIS LIMITED WARRANTY AND/OR SALES.

