

User's Manual

FORIS[®] **FS2332**

Color LCD Monitor

Important

Please read PRECAUTIONS, this User's Manual, and Setup Guide (separate volume) carefully to familiarize yourself with safe and effective usage.

-
- Please refer to the Setup Guide for basic information ranging from connection of the monitor to a PC or external device to using the monitor.
 - The latest User's Manual is available for download from our web site: <http://www.eizo.com>
-



Location of Caution Statement

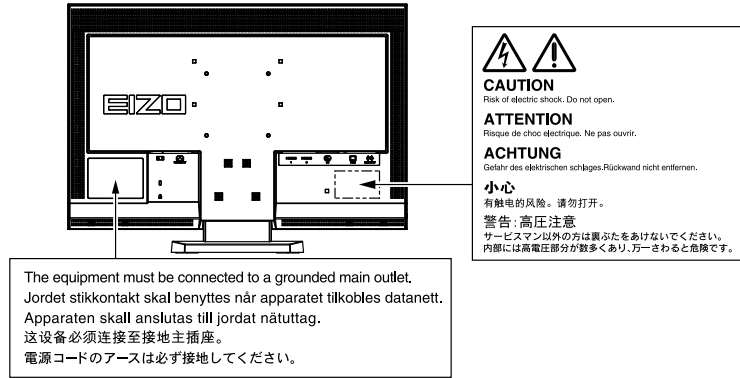

<For USA-California Only>

CR Coin Lithium Battery contains Perchlorate Material - special handling may apply.

See www.dtsc.ca.gov/hazardouswaste/perchlorate.

Product specification may vary with sales areas. Confirm the specification in the manual written in language of the region of purchase.

Copyright© 2011 EIZO NANA CORPORATION All rights reserved.

No part of this manual may be reproduced, stored in a retrieval system, or transmitted, in any form or by any means, electronic, mechanical, or otherwise, without the prior written permission of EIZO NANA CORPORATION.

EIZO NANA CORPORATION is under no obligation to hold any submitted material or information confidential unless prior arrangements are made pursuant to EIZO NANA CORPORATION's receipt of said information.

Although every effort has been made to ensure that this manual provides up-to-date information, please note that EIZO monitor specifications are subject to change without notice.

Notice for this monitor

This product is suited to creating documents, viewing multimedia content, and other general purposes.

This product has been adjusted specifically for use in the region to which it was originally shipped. If the product is used outside the region, it may not operate as specified in the specifications.

This product may not be covered by warranty for uses other than those described in this manual.

The specifications noted in this manual are only applicable for power cords and signal cables specified by us.

Use optional products manufactured or specified by us with this product.

As it takes about 30 minutes for the performance of electrical parts to stabilize, adjust the monitor 30 minutes or more after the monitor power has been turned on.

In order to suppress the luminosity change by long-term use and to maintain the stable luminosity, use of a monitor in lower brightness is recommended.

When the screen image is changed after displaying the same image for extended periods of time, an afterimage may appear. Use the screen saver or power save function to avoid displaying the same image for extended periods of time.

Periodic cleaning is recommended to keep the monitor looking new and to prolong its operation lifetime (refer to [“Cleaning” \(page 4\)](#)).

The LCD panel is manufactured using high-precision technology. However, missing pixels or lit pixels may appear on the LCD panel, this is not malfunction. Percentage of effective dots: 99.9994% or higher.

The backlight of the LCD panel has a fixed life span. When the screen becomes dark or begins to flicker, please contact your dealer.

Do not press on the panel or edge of the frame strongly, as this may result in the display malfunction, such as the interference patterns, etc. If pressure is continually applied to the panel, it may deteriorate or damage your panel. (If the pressure marks remain on the panel, leave the monitor with a white or black screen. The symptom may disappear.)

Do not scratch or press on the panel with any sharp objects, as this may result in damage to the panel. Do not attempt to brush with tissues as this may scratch the panel.

When the monitor is cold and brought into a room or the room temperature goes up quickly, dew condensation may occur inside and outside the monitor. In that case, do not turn the monitor on and wait until dew condensation disappears, otherwise it may cause some damages to the monitor.

Cleaning

Attention

- Chemicals such as alcohol and antiseptic solution may cause gloss variation, tarnishing, and fading of the cabinet or panel, and also quality deterioration of the image.
- Never use any solvents or chemicals, such as thinner, benzene, wax, alcohol, and abrasive cleaner, which may damage the cabinet or panel.

Note

- Optional ScreenCleaner is recommended for cleaning the panel surface.

● Panel

- Clean the panel with a soft cloth such as cotton cloth or lens cleaning paper.
- If necessary, stubborn stains can be removed by moistening part of a cloth with water to enhance its cleaning power. After that, clean the panel again with a dry cloth for better finishing.

● Cabinet

- Clean the cabinet with a soft cloth dampened with a little mild detergent.

To use the monitor comfortably

- An excessively dark or bright screen may affect your eyes. Adjust the brightness of the monitor according to the environmental conditions.
- Staring at the monitor for a long time tires your eyes. Take a 10-minute rest every hour.

CONTENTS

Cover	1	2-4. Screen Adjustment	23
Location of Caution Statement	2	● Digital Signal Input	23
Notice for this monitor	3	● Analog Signal Input	23
Cleaning	4	2-5. Screen Size Changing	27
● Panel	4	● Analog Input (D-Sub)/Digital Input (DVI-D, HDMI: PC signal)	27
● Cabinet	4	● Digital Input (HDMI: video signal)	28
To use the monitor comfortably	4	To set the screen ratio "Overscan"	28
CONTENTS	5	Chapter 3 Setting Monitor	29
Chapter 1 Introduction	7	3-1. Adjusting Volume	29
1-1. Features	7	● To turn the volume up/down	29
1-2. Controls and Functions	8	● To mute the sound temporarily	29
● Before Using Remote Control	9	3-2. Switching sound source for HDMI signal input "Source"	29
How to install battery	9	3-3. To adjust the sound level "Sound Level" ...	30
Receivable Range of Remote Control	9	3-4. Enabling/Disabling DDC/CI communication "DDC/CI"	30
1-3. EIZO LCD Utility Disk	10	3-5. Locking Buttons "Key Lock"	30
● Disk contents and software overview	10	3-6. Setting the EIZO Logo Display "Logo"	31
● To use "ScreenManager Pro for LCD(DDC/CI)/EIZO ScreenSlicer"	10	3-7. Setting Language "Language"	31
1-4. Basic Operations and Functions	11	3-8. Changing the authentication method for HDMI signal input	31
● Basic operation of the Setting menu	11	3-9. Resetting the Monitor to the Default Settings	32
● Functions	12	● To reset the color adjustments "Color Reset" ...	32
Chapter 2 Adjusting Screens	13	● To reset all adjustments to the default settings "Reset"	32
2-1. Compatible Resolutions/Formats	13	Chapter 4 Power Saving Functions	33
Analog Input (D-Sub)	13	4-1. Setting Power Saving "Power Save"	33
Digital Input (DVI-D, HDMI: PC signal)	13	● Monitor	33
Digital Input (HDMI: video signal)	13	● Audio Output	34
2-2. Setting the Resolution	14	4-2. Setting Power Indicator "Power Indicator"	34
Windows 7	14	4-3. Enabling/Disabling Automatic Brightness Adjustment "Auto EcoView" ...	35
Windows Vista	14	4-4. Checking the power saving level	35
Windows XP	14	4-5. Enabling/Disabling Auto Power-OFF "Off Timer (min)"	35
Mac OS X	14	Chapter 5 Connecting Cables	37
2-3. Adjusting Color	15	5-1. Connecting Multiple External Devices	37
● To select the display mode (Color Mode)	15	● To switch among input signals	37
● To perform advanced adjustments	16	Chapter 6 Troubleshooting	38
● Adjustable settings in each mode	16	Chapter 7 Reference	42
● To adjust brightness "Brightness"	17	7-1. How to Attach the Optional Arm	42
● To adjust black level "Black Level"	17	7-2. Attaching the Stand base	43
● To adjust contrast "Contrast"	17	7-3. Displaying Monitor Information "Information"	43
● To adjust the color saturation "Saturation"	18		
● To adjust hue "Hue"	18		
● To adjust color temperature "Temperature" ...	19		
● To adjust gamma "Gamma"	20		
● To adjust gain "Gain"	20		
● To set ContrastEnhancer "ContrastEnhancer"	21		
● To adjust the clarity of the image "Smart Resolution"	22		
● To set overdrive intensity "Overdrive"	23		

7-4. Specifications	44
7-5. Glossary.....	47
7-6. Preset Timing	49
Appendix.....	50
Trademark	50
License	50
ENERGY STAR.....	50
TCO	51
FCC Declaration of Conformity	51
Hinweise zur Auswahl des richtigen Schwenkarms für Ihren Monitor	52
Hinweis zur Ergonomie :	52
LIMITED WARRANTY.....	53
China Measures for RoHS Compliance in ChinaRoHS	62

Chapter 1 Introduction

Thank you very much for choosing an EIZO color LCD monitor.

1-1. Features

- 23" wide format LCD
- Applicable to the resolution of 1920 × 1080.
- Panel with a wide field of view adopted
IPS panel with 178° horizontal and vertical viewing angles.
- HDMI connector × 2
Applicable to the PC input signal using HDMI input, allowing three different digital signal inputs from a PC.
- The Color Mode function allows the user to select the display mode optimum to the displayed image.
The Paper mode reproduces an easy-on-the-eyes display that looks just like printed paper.
See [“To select the display mode \(Color Mode\)” \(page 15\)](#).
- ContrastEnhancer function
Automatically adjusts the contrast according to the image, enabling the display of high contrast and sharp animated images.
See [“To set ContrastEnhancer “ContrastEnhancer”” \(page 21\)](#).
- Smart Resolution function
You can display images vividly and clearly by enhancing the perceived resolution of the images.
In addition, a display that does not appear unnatural or distorted can be created by detecting the skin tones, texts, and video areas of the images and correcting each feature.
See [“To adjust the clarity of the image “Smart Resolution”” \(page 22\)](#).
- Two dedicated gamma modes (“Power1”/“Power2”) suitable for game images implemented
The images will be sharpened by increasing the halftone (Power1) and low-tone (Power2) contrasts.
See [“To adjust gamma “Gamma”” \(page 20\)](#).
- A variety of Screen Size can be selected, such as dot by dot (image is displayed without scaling the input signals), Letterbox, Overscan (change of the display area of the input image)
See [“2-5. Screen Size Changing” \(page 27\)](#).
- The software “ScreenManager Pro for LCD (DDC/CI)” to adjust the screen using the mouse and keyboard is included.
See [“1-3. EIZO LCD Utility Disk” \(page 10\)](#).
- Remote control enables easy operation, setting and adjustment of the monitor.
See [“1-2. Controls and Functions” \(page 8\)](#).
- Color sheets (in three colors) to be pasted at the bottom of the monitor included
Select your desired color to add an accent to the monitor.
See “Setup Guide”.
- HDCP (High-bandwidth Digital Content Protection)
- Built-in stereo speakers and headphone jack
See [“1-2. Controls and Functions” \(page 8\)](#).

1-2. Controls and Functions

Monitor

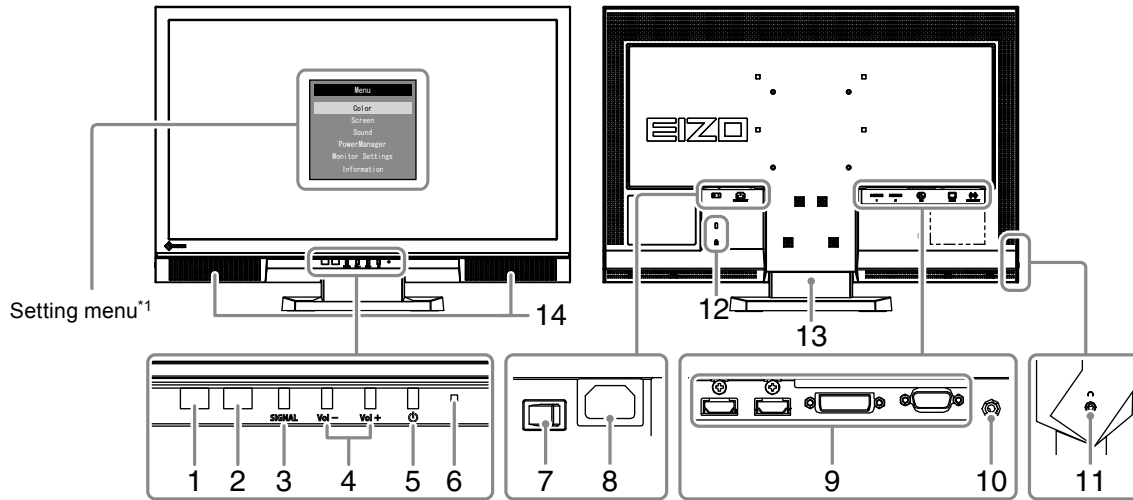

1. Auto EcoView sensor	Detects ambient brightness. Auto EcoView function (page 35).
2. Remote control detector	Receives the signal from the remote control.
3. SIGNAL button	Switches input signals for display (page 37). PC1 (DVI) → PC2 (D-SUB) → HDMI1 → HDMI2
4. Vol - / Vol + button	Displays the volume adjustment menu to volume up or down.
5. ⏻ button	Turns the power on or off.
6. Power indicator	Indicates the monitor's operation status. Blue: Operating Orange: Power saving mode Red: Power off OFF: Main power off
7. Main power switch	Turns the main power on or off.
8. Power connector	Connects the power cord.
9. Input signal connector	Left: HDMI connector × 2 (HDMI1, HDMI2) / Center: DVI-D connector / Right: D-Sub mini 15-pin connector
10. Stereo mini jack	Connects the stereo mini jack cable.
11. Headphone jack	Connects the headphones.
12. Security lock slot	Complies with Kensington's MicroSaver security system.
13. Stand*²	Used to adjust the angle of the monitor screen.
14. Speaker	Outputs audio source.

*¹ See “[Basic operation of the Setting menu](#)” ([page 11](#)) for how to use.

*² An optional arm (or an optional stand) can be attached by removing the stand (see “[7-1. How to Attach the Optional Arm](#)” ([page 42](#))).

Remote Control

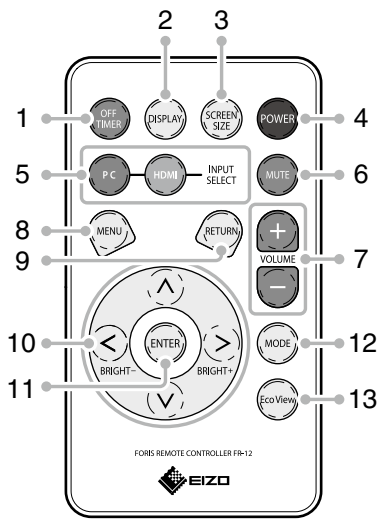

1. OFF TIMER	Sets the time until the monitor power-off.
2. DISPLAY	Displays the current input port.
3. SCREEN SIZE	Changes the screen size.
4. POWER	Turns the power on or off.
5. INPUT SELECT	Switches input signals for display.
PC	PC1 (DVI) → PC2 (D-SUB)
HDMI	HDMI1 → HDMI2
6. MUTE	Mutes sound temporarily.
7. VOLUME +/-	Adjusts the volume.
8. MENU	Displays/Exits the Setting menu.
9. RETURN	Returns to the previous menu in menu operation.
10. </^/∨/ >	<ul style="list-style-type: none"> Chooses and increases/decreases adjustment settings for advanced adjustment using the Setting menu. </ > : Displays the brightness adjustment menu (page 17).
11. ENTER	Determines an item on the menu screen, and saves values adjusted.
12. MODE	Changes the color mode.
13. EcoView	Displays/Exits the EcoView menu.

● Before Using Remote Control

How to install battery

1. While pushing the tab toward the arrow (1), pull out the battery case (2).
2. Insert a battery with the positive side up. (Battery model number: CR2032)
3. Insert the battery case until it clicks.

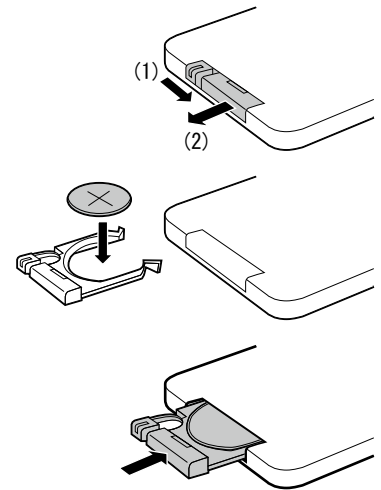

Receivable Range of Remote Control

Use the remote control inside of the range as below.

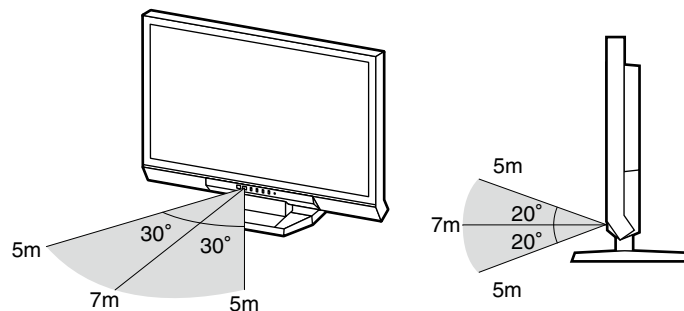

1-3. EIZO LCD Utility Disk

An “EIZO LCD Utility Disk” (CD-ROM) is supplied with this product. The following table shows the disk contents and the overview of the software programs.

● Disk contents and software overview

The disk includes software programs for adjustment, and User’s Manual. Refer to Readme.txt file on the disk for software startup procedures or file access procedures.

Item	Overview	Windows	Macintosh
A Readme.txt file		√	√
Screen adjustment pattern files	Used when adjusting the image of analog signal input manually.	√	√
ScreenManager Pro for LCD (DDC/CI)	Software for adjusting the screen using the mouse and keyboard This software does not run on a PC connected via the HDMI input.	√	-
EIZO ScreenSlicer	Software that divides a screen and lays out multiple windows efficiently.	√	-
User’s Manual of this monitor (PDF file)		√	√

● To use “ScreenManager Pro for LCD(DDC/CI)/EIZO ScreenSlicer”

For the installation and use of “ScreenManager Pro for LCD(DDC/CI)/EIZO ScreenSlicer”, refer to the respective User’s Manual on the disk.

1-4. Basic Operations and Functions

● Basic operation of the Setting menu

1. Displaying the Setting menu

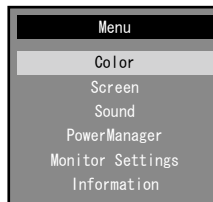

1. Press  on the remote control. The Setting menu appears.





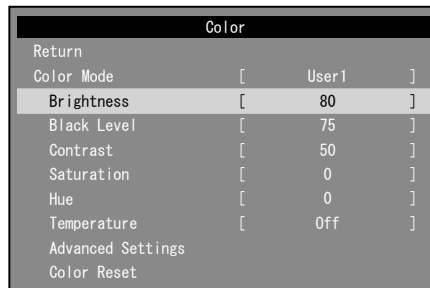

2. Adjusting/Setting

1. Choose a menu to adjust/set with , , and then press . The Sub menu appears.



2. Choose an item to adjust/set with , , and then press . The adjustment/ setting menu appears.



3. Adjust/set the selected item with , , , , and then press .

3. Exiting

1. Press .

Note

- To go back to the previous menu, press .
-

● Functions

The following table shows all the Setting menu's adjustment and setting menus.

Main menu	Setting	Reference	
Color ^{*1}	Color Mode	"2-3. Adjusting Color" (page 15)	
	Brightness		
	Black Level		
	Contrast		
	Saturation		
	Hue		
	Temperature		
	Advanced Settings		Gamma
			Gain
		ContrastEnhancer	
Smart Resolution			
Overdrive			
Color Reset	"3-9. Resetting the Monitor to the Default Settings" (page 32)		
Screen	Auto Screen Adjust ^{*2}	"2-4. Screen Adjustment" (page 23)	
	Auto Range Adjust ^{*2}		
	Clock ^{*2}		
	Phase ^{*2}		
	Position ^{*2}		
	Color Space ^{*3}		
	Smoothing		
Sound	Source ^{*3}	"3-2. Switching sound source for HDMI signal input "Source"" (page 29)	
	Sound Level	"3-3. To adjust the sound level "Sound Level"" (page 30)	
	Power Save	"4-1. Setting Power Saving "Power Save"" (page 33)	
PowerManager	Power Save	"4-1. Setting Power Saving "Power Save"" (page 33)	
Monitor Settings	DDC/CI	"3-4. Enabling/Disabling DDC/CI communication "DDC/CI"" (page 30)	
	Key Lock	"3-5. Locking Buttons "Key Lock"" (page 30)	
	Logo	"3-6. Setting the EIZO Logo Display "Logo"" (page 31)	
	Power Indicator	"4-2. Setting Power Indicator "Power Indicator"" (page 34)	
	Language	"3-7. Setting Language "Language"" (page 31)	
	Reset	"3-9. Resetting the Monitor to the Default Settings" (page 32)	
Information		"7-3. Displaying Monitor Information "Information"" (page 43)	

^{*1} The adjustment/settings available on the "Color" menu depend on the selected Color mode. The above table shows the sub menus when the User1 or User2 mode is selected.

^{*2} These functions can be adjusted with analog input.

^{*3} This function is available with HDMI signal input.

Chapter 2 Adjusting Screens

2-1. Compatible Resolutions/Formats

The monitor supports the following resolutions and signal format.

Analog Input (D-Sub)

Resolution	Applicable Signals	Vertical Scan Frequency	Dot Clock
640 × 480	VGA, VESA, CEA-861	up to 75 Hz	148.5 MHz (Max.)
720 × 400	VGA TEXT	70 Hz	
800 × 600	VESA	up to 75 Hz	
1024 × 768	VESA	up to 75 Hz	
1280 × 720	CEA-861	60 Hz	
1280 × 960	VESA	60 Hz	
1280 × 1024	VESA	up to 75 Hz	
1680 × 1050	VESA CVT, VESA CVT RB	60 Hz	
1920 × 1080*	CEA-861	60 Hz	

Digital Input (DVI-D, HDMI: PC signal)

Resolution	Applicable Signals	Vertical Scan Frequency	Dot Clock
640 × 480	VGA, CEA-861	60 Hz	148.5 MHz (Max.)
720 × 400	VGA TEXT	70 Hz	
800 × 600	VESA	60 Hz	
1024 × 768	VESA	60 Hz	
1280 × 720	CEA-861	60 Hz	
1280 × 960	VESA	60 Hz	
1280 × 1024	VESA	60 Hz	
1680 × 1050	VESA CVT, VESA CVT RB	60 Hz	
1920 × 1080*	CEA-861	60 Hz	

A graphics board in conformance with the VESA and CEA-861 standards is required.

*Recommended resolution

Digital Input (HDMI: video signal)

- Video signal
 - VGA / 525p (480p) / 750p (720p) / 1125p (1080p): 60 Hz
 - 625p (576p) / 750p (720p) / 1125p (1080p): 50 Hz
- Audio signal
 - 2ch linear PCM (32 kHz / 44.1 kHz / 48 kHz)

2-2. Setting the Resolution

When you connect the monitor to the PC and find that the resolution is improper, or when you want to change the resolution, follow the procedure below.

Windows 7

1. Right-click the mouse anywhere on the desktop except for icons.
2. From the displayed menu, click “Screen resolution”.
3. On the “Screen Resolution” dialog box, select the monitor.
4. Click “Resolution” to select the desired resolution.
5. Click the [OK] button.
6. When a confirmation dialog box is displayed, click [Keep changes].

Windows Vista

1. Right-click the mouse anywhere on the desktop except for icons.
2. From the displayed menu, click “Personalize”.
3. On the “Personalization” window, click “Display Settings”.
4. On the “Display Settings” dialog box, select the “Monitor” tab and select desired resolution in the “Resolution” field.
5. Click the [OK] button.
6. When a confirmation dialog box is displayed, click [Yes].

Windows XP

1. Right-click the mouse anywhere on the desktop except for icons.
2. From the displayed menu, click “Properties”.
3. When the “Display Properties” dialog box is displayed, click the “Settings” tab and select desired resolution for “Screen resolution” under “Display”.
4. Click the [OK] button to close the dialog box.

Mac OS X

1. Select “System Preferences” from the Apple menu.
2. When the “System Preferences” dialog box is displayed, click “Displays” for “Hardware”.
3. On the displayed dialog box, select the “Display” tab and select desired resolution in the “Resolutions” field.
4. Your selection will be reflected immediately. When you are satisfied with the selected resolution, close the window.

2-3. Adjusting Color

● To select the display mode (Color Mode)



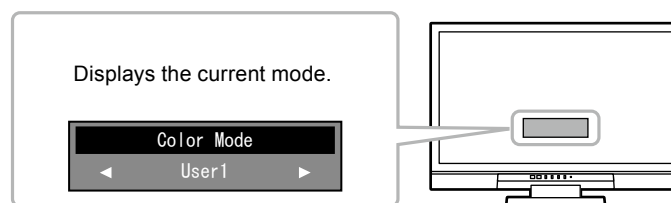

This function allows easy selection of a desired mode according to monitor application.

Display Modes

Mode	Purpose
User1	Select one of these user modes to define a desired set of parameter settings.
User2	
sRGB	Suitable for color matching with sRGB compatible peripherals.
Paper	Produces a printed paper effect by decreasing contrast and color temperature.
Game	Suitable for displaying game images.
Cinema	Suitable for displaying movie-like images.



Procedure

1. Press  on the remote control.
The mode name appears at the center of the screen.
2. The mode among the list is highlighted in turn each time  is pressed.
You can switch the current mode with  or  while the mode menu is being displayed.

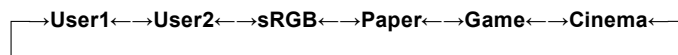

Note

- The Setting menu and the Mode menu cannot be displayed at the same time.
- “ScreenManager Pro for LCD (DDC/CI)” allows you to select the Color mode automatically according to the application used (see “Chapter 3 Auto Fine-Contrast” in the “ScreenManager Pro for LCD (DDC/CI)” User’s Manual).

● To perform advanced adjustments

The “Color” menu of the Setting menu allows you to set and save the independent color adjustment for each mode.

Attention

- The monitor will take about 30 minutes before its internal electric components stabilize. Wait 30 minutes or more after turning the monitor power on before starting adjustment.
- Perform the range adjustment first when adjusting color for analog signals (see “To adjust color gradation automatically “Auto Range Adjust”” (page 26)).
- The same image may be seen in different colors on multiple monitors due to their monitor-specific characteristics. Make fine color adjustment visually when matching colors on multiple monitors.

Note

- The value shown in “K” is available only as reference.
- Using the “ScreenManager Pro for LCD (DDC/CI)” allows you to perform the color adjustment by using the mouse and keyboard of your PC. (Refer to “Chapter 4 Color Adjustment” in the User’s Manual for “ScreenManager Pro for LCD (DDC/CI)”.)

● Adjustable settings in each mode

The adjustable settings depend on the mode. (You cannot select any non-adjustable or non-settable function.) For instructions on how to adjust or set each function, refer to subsequent pages.

√: Adjustable - : Not adjustable

Function		Color Mode				
		User1 User2	sRGB	Paper	Game	Cinema
Brightness		√	√	√	√	√
Black Level		√	-	-	√	√
Contrast		√	-	-	√	√
Saturation		√	-	-	√	√
Hue		√	-	-	√	√
Temperature		√	-	√	√	√
Advanced Settings	Gamma	√	-	-	√	-
	Gain	√	-	-	-	-
	ContrastEnhancer	√	-	-	√	√
	Smart Resolution	√	-	√	√	√
	Overdrive	√	-	-	√	-
Color Reset		√	√	√	√	√





● To adjust brightness “Brightness”

The screen brightness is adjusted by changing the brightness of the backlight (light source from the LCD back panel).

Adjustable range

0 to 100

Procedure

1. Press  or .
- The Brightness menu appears.
2. Use  or  for adjustment.
3. Press  to exit.

Note

- If you feel that the image is too dark even if the brightness is set to 100, adjust the contrast.
 - Alternatively, you can use “Brightness” under “Color” in the Adjustment menu to adjust it.
-





● To adjust black level “Black Level”

You can adjust the black level of images.

Adjustable range

0 to 100

Procedure

1. Choose “Color” in the Setting menu, and press .
2. Choose “Black Level” in the “Color” menu, and press .
- The “Black Level” menu appears.
3. Use  or  for adjustment.
4. Press  to exit the adjustment.

Note

- After completing black level adjustment, readjust the contrast as appropriate.
-





● To adjust contrast “Contrast”

The brightness of the screen is adjusted by varying the video signal level.

Adjustable range

0 to 100

Procedure

1. Choose “Color” in the Setting menu, and press .
2. Choose “Contrast” in the “Color” menu, and press .
- The “Contrast” menu appears.
3. Use  or  for adjustment.
4. Press  to exit the adjustment.

Note

- In the contrast of 50, every color gradation is displayed (for PC input signal only).
 - When adjusting the monitor, it is recommended to perform the brightness adjustment which may not lose the gradation characteristics, prior to the contrast adjustment.
 - Perform the contrast adjustment in the following cases.
 - When you feel the image is too dark even if the brightness is set to 100 (Set the contrast to higher than 50.)
-





● To adjust the color saturation “Saturation”

This function allows you to adjust color saturation.

Adjustable range

-50 to 50

Procedure

1. Choose “Color” in the Setting menu, and press .
2. Choose “Saturation” in the “Color” menu, and press .
- The “Saturation” menu appears.
3. Use  or  for adjustment.
4. Press  to exit the adjustment.

Attention

- Using this function may make some color gradations unavailable for display.

Note

- The minimum value (-50) changes the screen to monochrome.
-





● To adjust hue “Hue”

This function allows you to adjust hue.

Adjustable range

-50 to 50

Procedure

1. Choose “Color” in the Setting menu, and press .
2. Choose “Hue” in the “Color” menu, and press .
- The “Hue” menu appears.
3. Use  or  for adjustment.
4. Press  to exit the adjustment.

Attention

- Using this function may make some color gradations unavailable for display.
-

● To adjust color temperature “Temperature”

Color temperature can be adjusted.





The color temperature is normally used to express the hue of “White” and/or “Black” by a numerical value. The value is expressed in degrees “K” (Kelvin).

The screen becomes reddish at a low color temperature, and bluish at a high color temperature, like the flame temperature. A gain preset value is set for each color temperature setting value.

Adjustable range

Off, 4000K-10000K (specified by every 500K unit, including 9300K)

Procedure

1. Choose “Color” in the Setting menu, and press .
2. Choose “Temperature” in the “Color” menu, and press .
The “Temperature” menu appears.
3. Use  or  for adjustment.
4. Press  to exit the adjustment.

Note

- “Gain” allows you to perform more advanced adjustment (see [“To adjust gain “Gain”” \(page 20\)](#)).
 - If you set to “Off”, the image is displayed in the preset color of the monitor (Gain: 100 for each RGB).
 - When gain is changed, the color temperature is changed to “Off”.
-







● To adjust gamma “Gamma”

Gamma can be adjusted. The brightness of the monitor varies depending on the input signal, however, the variation rate is not proportional to the input signal. To keep the balance between the input signal and the brightness of the monitor is called as “Gamma correction”.

Adjustable range

1.8, 2.0, 2.2, 2.4, 2.6, 2.8, Power1, Power2

Procedure

1. Choose “Color” in the Setting menu, and press .
2. Choose “Advanced Settings” in the “Color” menu, and press .
3. Choose “Gamma” in the “Advanced Settings” menu, and press .
- The “Gamma” menu appears.
4. Use  or  for adjustment.
5. Press  to exit the adjustment.

Note

- Choosing “Power1” will help to sharpen halftone images by increasing their contrast.
 - Choosing “Power2” will help to make dark images visible by increasing the low-tone contrast.
-







● To adjust gain “Gain”

The brightness of each color component red, green, and blue is called “Gain”. You can change the hue of “white” by adjusting gain.

Adjustable range

0 to 100

Procedure

1. Choose “Color” in the Setting menu, and press .
2. Choose “Advanced Settings” in the “Color” menu, and press .
3. Choose “Gain” in the “Advanced Settings” menu, and press .
- The “Gain” menu appears.
4. Adjust gain with  or  for each of red, green, and blue.
5. Press  to exit the adjustment.

Attention

- Using this function may make some color gradations unavailable for display.
-







Note

- The value of gain changes with that of color temperature.
 - When gain is changed, the color temperature is changed to “Off”.
-

● To set ContrastEnhancer “ContrastEnhancer”

This function allows you to set whether to automatically adjust the contrast according to the darkness or brightness of a scene, for example.

Procedure

1. Choose “Color” in the Setting menu, and press .
2. Choose “Advanced Settings” in the “Color” menu, and press .
3. Choose “ContrastEnhancer” in the “Advanced Settings” menu, and press .
The “ContrastEnhancer” menu appears.
4. Select “Enable” or “Disable” with  or .
5. Press  to exit the adjustment.

Note

- Setting “Enable” allows you to display high contrast and sharp images.
-

● To adjust the clarity of the image “Smart Resolution”

You can display images vividly and clearly by enhancing the perceived resolution of the images. In addition, a display that does not appear unnatural or distorted can be created by detecting the skin tones, texts, and video areas of the images and correcting each feature.

This product allows you to set the perceived resolution (“Level”) and to set the correction of the perceived resolution for the skin tones, texts, and video areas (“Skin Tone Enhancer”, “Text Enhancer”, “Video Area Enhancer”).

The details of the correction are shown below:

Skin Tone Enhancer	Detects the skin tone in the image, and corrects the skin tone to look natural.
Text Enhancer	Detects the text in the image, and corrects the coloring of the text and blurring around the text. (Use of the digital signal input is recommended.)
Video Area Enhancer	The setting for the most suitable perceived resolution for the animated and still images differs, so the same setting shows different visual impressions. Detects the animated images, and corrects the images so that the animated and still images show the same visual impressions.











Attention

- “Text Enhancer” is enabled only when “Screen Size” is set to “Normal”.
- “Video Area Enhancer” is enabled only during the digital signal input.







Note

- Set “Level” to “Off” so “Smart Resolution” does not function.
- When “Level” is set to “Off”, “Skin Tone Enhancer”, “Text Enhancer”, and “Video Area Enhancer” cannot be selected.

Procedure

1. Choose “Color” in the Setting menu, and press .
2. Choose “Advanced Settings” in the “Color” menu, and press .
3. Choose “Smart Resolution” in the “Advanced Settings” menu, and press .
4. Choose “Level” in the “Smart Resolution” menu, and press .
- The “Level” menu appears.
5. Use  or  for adjustment.
6. To complete the setting, proceed to step 9.
To continuously set “Skin Tone Enhancer”, “Text Enhancer”, and “Video Area Enhancer”, proceed to step 7.
7. Choose the item to correct, and press .
- Each setting menu appears.
8. Select “Enable” or “Disable” with  or .
9. Press  to exit the adjustment.

Note

- The setting status of “Level”, “Skin Tone Enhancer”, “Text Enhancer”, and “Video Area Enhancer” can be checked on the demo screen.
If you keep pressing the  or  button for two seconds or more while “Smart Resolution” is displayed, the monitor enters the demo mode. To return to normal display, keep pressing  or  for at least two seconds.
 - Left half of screen: Smart Resolution On
 - Right half of screen: Smart Resolution Off
- During the demo mode, each setting can be changed.
If the “Setting menu” is not displayed, press , , or  to display the menu again.
- When “Video Area Enhancer” is set to “Enable”, the magenta colored frame that covers the area detected as an animated image appears.







● To set overdrive intensity “Overdrive”

This function allows you to set overdrive intensity based on the use of the monitor. You can reduce Image lags by setting it to “Enhanced” when displaying animated images.

Adjustable range

Enhanced, Standard, Off

Procedure

1. Choose “Color” in the Setting menu, and press .
2. Choose “Advanced Settings” in the “Color” menu, and press .
3. Choose “Overdrive” in the “Advanced Settings” menu, and press .
- The “Overdrive” menu appears.
4. Use  or  for adjustment.
5. Press  to exit the adjustment.

Attention

- The overdrive function is disabled in the following cases:
 - The vertical scan frequency of input signals is more than 60 Hz
 - The screen size is “Normal” (excluding the case that the display resolution is 1920 x 1080) or “Letterbox”
-

2-4. Screen Adjustment

● Digital Signal Input

When digital signals are input, images are displayed correctly based on the preset data of the monitor, but if characters and/or lines appear blurred, go to [“6. Modify blurred characters or lines.” \(page 27\)](#).

When performing more advanced adjustment, see [“2-3. Adjusting Color” \(page 15\)](#) and subsequent pages.

● Analog Signal Input

Attention

- The monitor will take about 30 minutes before its internal electric components stabilize. Wait 30 minutes or more after turning the monitor power on before starting adjustment.
 - The Self Adjust (automatic screen adjustment) function does not work for the images under the resolution of 800 × 600 (SVGA).
 - The self adjustment (or automatic screen adjustment) function works correctly when an image is fully displayed over the Windows or Macintosh display area. They do not work properly in the cases below:
 - When an image is displayed only on a part of the screen (command prompt window, for example)
 - When a black background (wallpaper, etc.) is in useAlso, these functions cannot work properly in some graphic boards.
-

The monitor screen adjustment is used to suppress flickering of the screen or adjust screen position and screen size correctly according to the PC to be used.

Note

- The Self Adjust function works when all of the following conditions are satisfied:
 - When a signal is input into the monitor for the first time or when a resolution or vertical/horizontal scan frequency not used before is set
-





If the screen is not displayed correctly even after performing the Self Adjust operation, adjust the screen according to the procedures on the following pages to use the monitor comfortably.

Setting Procedures

1. Perform the auto adjustment.

- To adjust flickering, screen position, and screen size automatically “Auto Screen Adjust”

Procedure

1. Choose “Screen” in the Setting menu, and press .
2. Choose “Auto Screen Adjust” in the “Screen” menu, and press .
3. Select “Yes” with  or , and press .

Flickering, screen position, and screen size are corrected by the auto-adjustment function.

If the screen is not displayed correctly even after performing “1. Perform the auto adjustment.” (page 24), perform the adjustments according to the procedures on the following pages. If the screen is displayed correctly, go to “5. Adjusting color gradation.” (page 26).

2. Prepare to use analog screen adjustment patterns.

Load the “EIZO LCD Utility Disk” to your PC, and then open the “Screen adjustment pattern files”.

Note

- For details and instructions on opening the “Screen adjustment pattern files”, refer to the Readme.txt file.





3. Perform the auto adjustment again with the analog screen adjustment pattern displayed.

- To adjust flickering, screen position, and screen size automatically “Auto Screen Adjust”

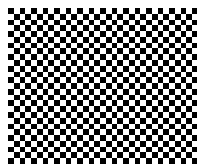
Procedure

1. Display Pattern 1 in full screen on the monitor using the “Screen adjustment pattern files”.



2. Choose “Screen” in the Setting menu, and press .
3. Choose “Auto Screen Adjust” in the “Screen” menu, and press .
4. Select “Yes” with  or , and press .

Flickering, screen position, and screen size are corrected by the auto-adjustment function.

If the screen is not displayed correctly even after performing “3. Perform the auto adjustment again with the analog screen adjustment pattern displayed.” (page 24), perform the adjustments according to the procedures on the following pages. If the screen is displayed correctly, go to “5. Adjusting color gradation.” (page 26).

4. Choose “Screen” from the Setting menu to perform advanced adjustments.



Adjust the clock, phase and position, in this order.



● To eliminate vertical bars “Clock”

Procedure

1. Choose “Clock” in the “Screen” menu, and press .

The “Clock” menu appears.

2. Adjust the clock with  or  to eliminate vertical bars.

Press  or  slowly so as not to miss the adjustment point.

3. Press  to exit the adjustment.

When blurring, flickering or bars appear on the screen after adjustment, proceed to “Phase” to remove flickering or blurring.

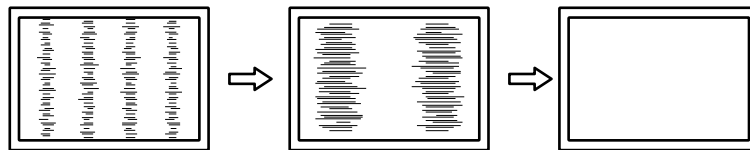

● To remove flickering or blurring “Phase”

Procedure

1. Choose “Phase” in the “Screen” menu, and press .

The “Phase” menu appears.

2. Adjust the phase with  or  to minimize flickering or blurring.

3. Press  to exit the adjustment.

When vertical bars appear on the screen after adjustment, go back to “To eliminate vertical bars “Clock””.

(Clock → Phase → Position)

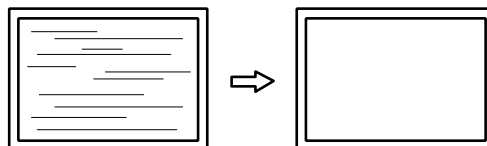

Attention







- Flickering or blurring may not be eliminated depending on your PC or graphics board.

● To correct the screen position “Position”

Note

- Since the number of pixels and the pixel positions are fixed on the LCD monitor, only one position is provided to display images correctly. The position adjustment is made to shift an image to the correct position.

Procedure

1. Choose “Position” in the “Screen” menu, and press .
The “Position” menu appears.
2. Adjust the position with  /  /  / .
3. Press  to exit the adjustment.

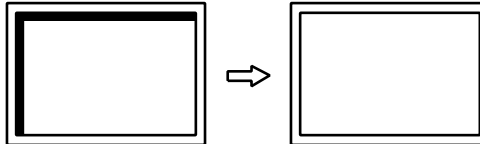

4. Close Pattern 1.

5. Adjusting color gradation.





● To adjust color gradation automatically “Auto Range Adjust”

Every color gradation (0 to 255) can be displayed by adjusting the signal output level.

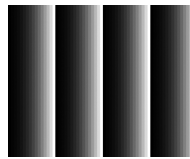
Procedure

1. Display Pattern 2 in full screen on the monitor using the “Screen adjustment pattern files”.



2. Choose “Screen” in the Setting menu, and press .
3. Choose “Auto Range Adjust” in the “Screen” menu, and press .
- The “Auto Range Adjust” menu appears.
4. Select “Yes” with  or , and press .
- The output range is set automatically.
5. Close Pattern 2.

6. Modify blurred characters or lines.

● To modify blurred characters/lines “Smoothing”

When an image is displayed with a resolution other than recommended, the characters or lines of the displayed image may blur.





Attention

- Smoothing setting may not be required depending on the display resolution. (You cannot choose the smoothing icon.)

Adjustable range

1 to 5

Procedure

1. Choose “Screen” in the Setting menu, and press .
2. Choose “Smoothing” in the “Screen” menu, and press .
The “Smoothing” menu appears.
3. Use  or  for adjustment.
4. Press  to exit the adjustment.

2-5. Screen Size Changing

● Analog Input (D-Sub)/Digital Input (DVI-D, HDMI: PC signal)



The image with the resolution other than the recommended resolution is displayed in full screen automatically. You can change the screen size by using the “Screen Size” function.

Setting	Function
Full Screen	Displays an image in full screen. Images are distorted in some cases because the vertical rate is not equal to the horizontal rate.
Enlarged	Displays an image in full screen. In some cases, a blank horizontal or vertical border appears to equalize the vertical rate and the horizontal rate.
Normal	Displays images with the specified resolution.

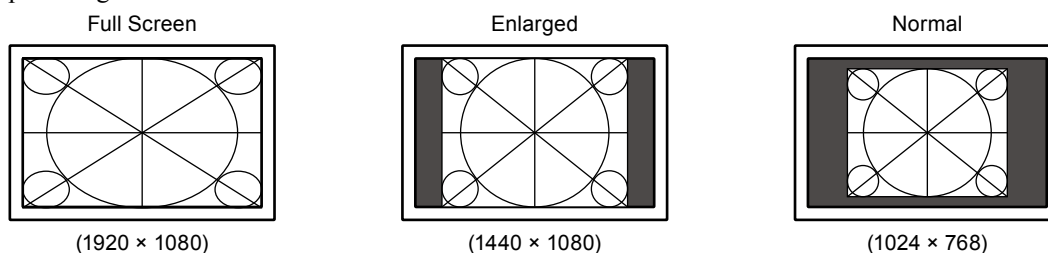
Example: Image size 1024 × 768



Procedure

1. Press  on the remote control.
Each time you press , the size changes.

Attention

- Selecting “Normal” may make some color gradations unavailable for display.

● Digital Input (HDMI: video signal)

The screen size can be changed with the “Screen Size” function.

Setting	Function	Screen Display
Auto	The monitor automatically changes the screen size according to the aspect ratio* ¹ and resolution information from the external device. This can be set only for HDMI (SD Signal) input.	
Full Screen	Displays an image in full screen. Images are distorted in some cases because the vertical rate is not equal to the horizontal rate.	
Enlarged	Displays an image in full screen. In some cases, a blank horizontal or vertical border appears to equalize the vertical rate and the horizontal rate.	
Letterbox	Displays Letterbox of 16 : 9 in full screen. Except for Letterbox, the upper and lower parts of the projected image are cut. This can be set only for HDMI (SD Signal) input.	
Normal* ²	The image is displayed without scaling the input signals.	

*¹ The aspect ratio information of letterbox cannot be identified automatically.

*² When “Screen Size” is “Normal”, “Overscan” is fixed at “Off”.

Procedure

1. Press on the remote control.
Each time you press , the size changes.

Attention

- Selecting “Normal” may make some color gradations unavailable for display.

To set the screen ratio “Overscan”

In order to hide distortion or noise at the image’s edge, the display area of the input image can be changed so that peripheral images are not displayed.

Setting	Function
On	Displays an input image in the screen by trimming the vertical and horizontal parts of the image.
Off	Displays most of the input image.

Procedure

1. Press on the remote control.
The “Screen Size” menu appears.
2. Select “Overscan” with .
3. Use or for adjustment.
4. Press to exit the adjustment.

Attention

- When “Screen Size” is “Normal”, “Overscan” is fixed at “Off”.

Chapter 3 Setting Monitor

3-1. Adjusting Volume



● To turn the volume up/down

This function allows you to adjust the volume.

Adjustable range

0 to 30

Procedure



1. Press  or  on the remote control.

Note

- Alternatively, you can use **Vol +** or **Vol -** on the monitor for adjustment. (see “1-2. Controls and Functions” (page 8)).
 - The volume setting is common for the HDMI input and stereo mini jack.
-

● To mute the sound temporarily

Procedure

1. Press  on the remote control.
Mute sound temporarily.
By pressing the button again or pressing , the sound comes back.





Note

- The mute setting can also be released by pressing **Vol +** on the monitor.
 - While the monitor is muted, press  or **Vol -** on the monitor to decrease the volume setting.
-

3-2. Switching sound source for HDMI signal input “Source”

This function allows you to switch sound source for HDMI signal input. You can select the HDMI or stereo mini jack.

Procedure

1. Choose “Sound” in the Setting menu, and press .
2. Choose “Source” in the “Sound” menu, and press .
- The “Source” menu appears.
3. Select “HDMI” or “Stereo Mini Jack” with  or .
4. Press  to exit the adjustment.

Note

- This function is available with HDMI signal input. However, if a DVI-HDMI adapter cable is used, the sound source is automatically “Stereo Mini Jack” and cannot be changed.
-

3-3. To adjust the sound level “Sound Level”





The input sound level can be adjusted.

The volume difference may occur depending on the kinds of input signals, since the average sound level of the external device differs.

Adjustable range

-1 to 1

Procedure

1. Choose “Sound” in the Setting menu, and press .
2. Choose “Sound Level” in the “Sound” menu, and press .
The “Sound Level” menu appears.
3. Use  or  for adjustment.
4. Press  to exit the adjustment.





Note

- For example, if the volume difference of PC1 and PC2 input signals becomes large, you can reduce the volume difference between them by raising the “Sound Level” of the lower volume side.
-

3-4. Enabling/Disabling DDC/CI communication “DDC/CI”

This function allows you to enable/disable the DDC/CI communication (see “7-5. Glossary” (page 47)).

Procedure

1. Choose “Monitor Settings” in the Setting menu, and press .
2. Choose “DDC/CI” in the “Monitor Settings” menu, and press .
The “DDC/CI” menu appears.
3. Select “Enable” or “Disable” with  or .
4. Press  to exit the adjustment.





Note

- HDMI input does not support DDC/CI communication.
-

3-5. Locking Buttons “Key Lock”

This function allows you to lock the buttons on the monitor.

Procedure

1. Choose “Monitor Settings” in the Setting menu, and press .
2. Choose “Key Lock” in the “Monitor Settings” menu, and press .
The “Key Lock” menu appears.
3. Select “On” with  or .
4. Press  to exit the adjustment.





Note

- The following operations are available even if the buttons are locked:
 - Turning on or off the monitor with the Power button
 - Does not lock the remote control operation.
-

3-6. Setting the EIZO Logo Display “Logo”

When the monitor is turned on, the EIZO logo appears on the screen. You can choose to display or not to display the EIZO logo.

Procedure

1. Choose “Monitor Settings” in the Setting menu, and press .
2. Choose “Logo” in the “Monitor Settings” menu, and press .
The “Logo” menu appears.
3. Select “On” or “Off” with  or .
4. Press  to exit the adjustment.





3-7. Setting Language “Language”

This function allows you to select a language for the Setting menu or displaying message.

Selectable languages

English/German/French/Spanish/Italian/Swedish/Japanese/Simplified Chinese/Traditional Chinese



Procedure

1. Choose “Monitor Settings” in the Setting menu, and press .
2. Choose “Language” in the “Monitor Settings” menu, and press .
The “Language” menu appears.
3. Choose a language with  or .
4. Press  to exit the adjustment.

3-8. Changing the authentication method for HDMI signal input



The external device cannot be authenticated successfully according to your external device and the screen cannot be displayed. In this case, follow the procedures below to change the authentication method.

Procedure

1. Press  on the remote control or  on the monitor to turn OFF the monitor power.
2. Press **SIGNAL** on the monitor for five seconds or more.
The authentication method changes and the monitor power is turned on.

Note

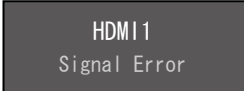
- The current authentication method can be identified based on the color used to display the input port or signal error.

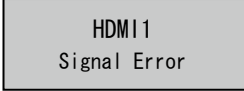
Method	Input port	Signal Error
1 (Default setting)		
2		

3-9. Resetting the Monitor to the Default Settings

There are two different Resets: Color Reset for only resetting the color adjustments to the default settings and Full Reset for resetting all settings to the defaults.

Attention

- After resetting, you cannot undo the operation.





Note

- Regarding the default setting, see [“Main Default Settings” \(page 45\)](#).
-

● To reset the color adjustments “Color Reset”

This function only resets the color adjustments for the currently selected mode to the default settings.

Procedure

1. Choose “Color” in the Setting menu, and press .
2. Choose “Color Reset” in the “Color” menu, and press .
3. Select “Yes” with  or .
4. Press .

The color adjustments revert to the default settings.





● To reset all adjustments to the default settings “Reset”

This function resets all adjustments to the default settings.

Attention

- The reset operation cannot return the authentication method for HDMI signal input ([“3-8. Changing the authentication method for HDMI signal input” \(page 31\)](#)) to the default setting.
-

Procedure

1. Choose “Monitor Settings” in the Setting menu, and press .
2. Choose “Reset” in the “Monitor Settings” menu, and press .
3. Select “Yes” with  or .
4. Press .

All adjustments revert to the default settings.

Chapter 4 Power Saving Functions

4-1. Setting Power Saving “Power Save”

● Monitor

This function allows you to specify whether to set the monitor into the power saving mode, depending on the state of an external device connected to it. When the monitor has shifted to the power saving mode, the images on the screen are not displayed.

Attention

- Turning off the main power switch or unplugging the power cord completely shuts off power supply to the monitor.
- Power consumption varies even when the stereo mini jack cable is connected.

Note

- The monitor changes to the power saving mode about 15 seconds after the signal input ceases to be detected.

Procedure

1. Choose “PowerManager” in the Setting menu, and press **ENTER**.
2. Choose “Power Save” in the “PowerManager” menu, and press **ENTER**.
The “Power Save” menu appears.
3. Select “Enable” or “Disable” with **<** or **>**.
4. Press **ENTER** to exit the adjustment.

Power Saving System

Analog Signal Input

This monitor complies with the VESA DPM standard.

PC		Monitor	Power Indicator
On		Operating	Blue
Power saving mode	STAND-BY SUSPENDED OFF	Power saving mode	Orange
Power Off		Power saving mode	Orange

Digital Signal Input

When the external device connected is a PC

This monitor complies with the DVI DMPM standard.

PC	Monitor	Power Indicator
On	Operating	Blue
Power saving mode	Power saving mode	Orange
Power Off	Power saving mode	Orange

When the external device connected is not a PC

Ext. Device	Monitor	Power Indicator
Power On	Operating	Blue
Power Off	Power saving mode	Orange

Attention

- When all the conditions below are met, the monitor does not change to the power saving mode even if “Power Save” is set to “Enable”:
 - “Power Save” for Sound is set to “Sound On” (“Audio Output” (page 34))
 - In the mute state (“To mute the sound temporarily” (page 29))In these cases, reset the mute.
-





Exiting the power saving mode

If the monitor receives input, it automatically exits the power saving mode and returns to the normal display mode.

● Audio Output

This monitor allows you to turn off the audio output from the speakers/headphone at the power saving mode.

Procedure

1. Choose “Sound” in the Setting menu, and press .
 2. Choose “Power Save” in the “Sound” menu, and press .
The “Power Save” menu appears.
 3. Select “Sound On” or “Sound Off” with  or .
 4. Press  to exit the adjustment.
-





Attention

- No audio is output while the monitor is in the Power Saving mode, if the HDMI signal is input or the sound source is of HDMI.
-

4-2. Setting Power Indicator “Power Indicator”

This function allows you to set the power indicator (blue) ON/OFF in the monitor ON condition.

Procedure

1. Choose “Monitor Settings” in the Setting menu, and press .
2. Choose “Power Indicator” in the “Monitor Settings” menu, and press .
The “Power Indicator” menu appears.
3. Select “Enable” or “Disable” with  or .
4. Press  to exit the adjustment.





4-3. Enabling/Disabling Automatic Brightness Adjustment “Auto EcoView”

The sensor on the front side of the monitor detects the environmental brightness to adjust the screen brightness automatically and comfortably by using the Auto EcoView function.

Attention

- Be careful not to block the sensor on the lower side of the monitor when using the Auto EcoView function.

Procedure

1. Press  on the remote control.
The “EcoView Menu” appears.
2. Select “On” or “Off” with  or .
3. Press  to exit the adjustment.

Note

- As “Brightness” in the Setting menu is changed, the auto adjustment range for Auto EcoView is also changed.

4-4. Checking the power saving level

The EcoView menu allows you to check Power Reduction, CO2 Reduction, and Eco Performance Level. The more indicators light up representing the Eco Performance Level, the higher the power saving level attained.

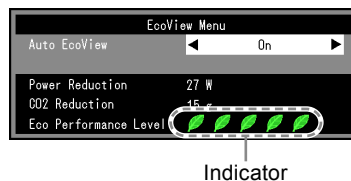

Procedure

1. Press  on the remote control.
The “EcoView Menu” appears.



4-5. Enabling/Disabling Auto Power-OFF “Off Timer (min)”

This function allows you to set the time to power off the monitor automatically.

Adjustable range

Disable, 30, 60, 90, 120, 150, 180

Procedure

1. Press  on the remote control.
Each time you press , the set time changes.



Cancelling procedure

1. Press  until “Disable” appears.

Checking the remaining time

1. Press  when the Off Timer is set.
The time to turn off the power appears.

Time extension procedure

1. Press  while the remaining time is displayed.
Each time you press , the time is extended.

Chapter 5 Connecting Cables

5-1. Connecting Multiple External Devices

The product has multiple connections to external devices and allows you to switch to one of the connections for display.

Attention

- Do not use dual link cables.

Connection examples

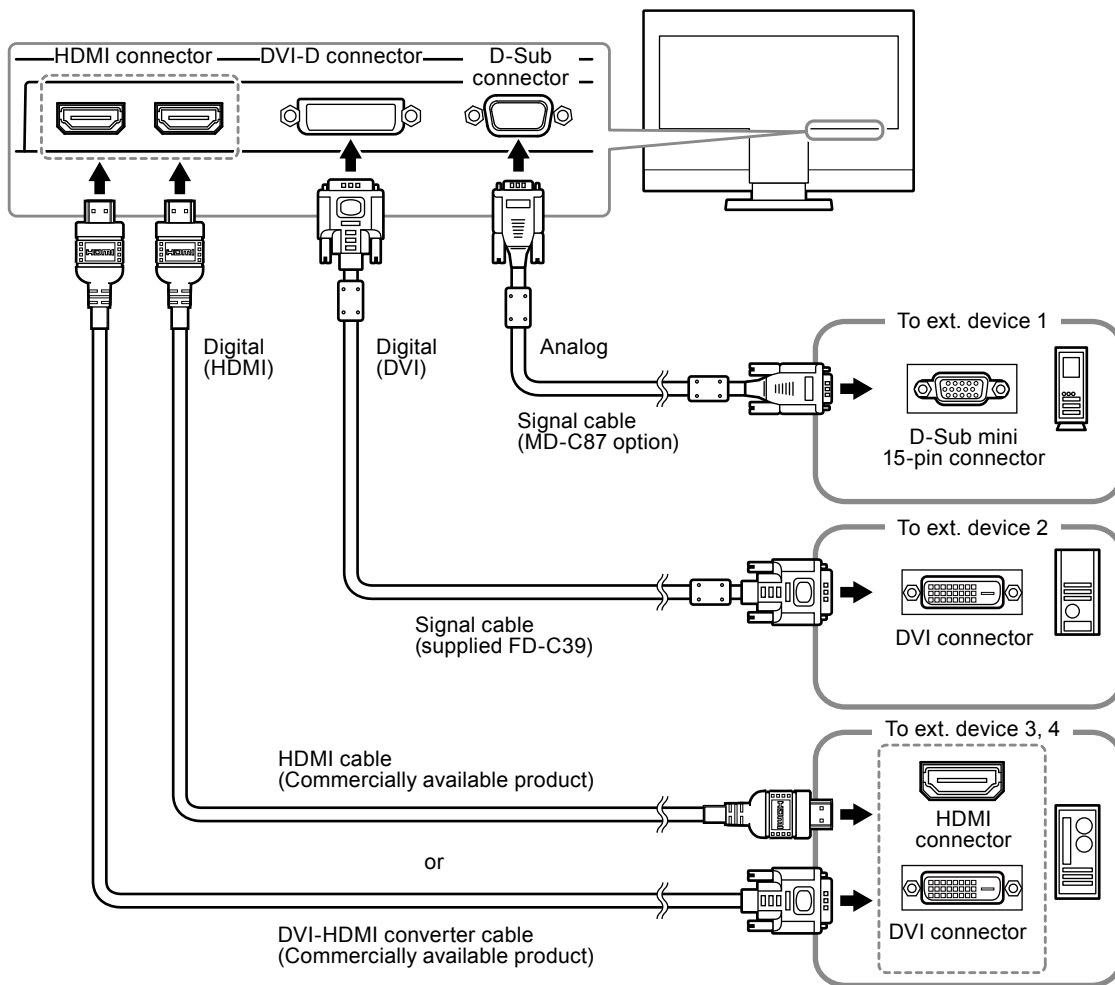

● To switch among input signals

Press **PC** or **HDMI** on the remote control to change the input signal.

When the signal is switched, the active input port name appears at the top right corner of the screen.

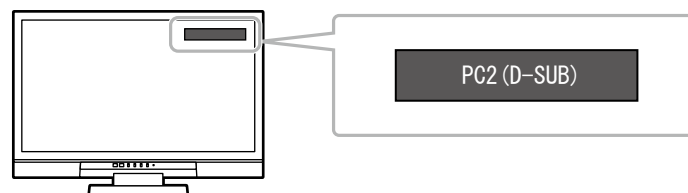



Note

- **SIGNAL** on the monitor also can change the input. (see “1-2. Controls and Functions” (page 8)).

Chapter 6 Troubleshooting

If a problem still remains after applying the suggested remedies, contact your local dealer.

No picture

Problem	Possible cause and remedy
1. No picture <ul style="list-style-type: none"> Power indicator does not light. 	<ul style="list-style-type: none"> Check whether the power cord is connected properly. Turn the main power switch on. Turn off the main power, and then turn it on again a few minutes later.
<ul style="list-style-type: none"> Power indicator is lighting red. 	<ul style="list-style-type: none"> Press  on the remote control (or  on the monitor).
<ul style="list-style-type: none"> Power indicator is lighting blue. 	<ul style="list-style-type: none"> Increase “Brightness”, “Contrast”, or “Gain” in the Setting menu (see “To perform advanced adjustments” (page 16)).
<ul style="list-style-type: none"> Power indicator is lighting orange. 	<ul style="list-style-type: none"> Check whether the signal cable is connected properly. Check whether the external device is turned on. Operate the mouse or keyboard. Switch the input signal. If an external device is plugged into the HDMI port, change the authentication method. Power off once and then press SIGNAL on the monitor for five seconds or more to change the authentication method and then turn on the power again.
2. The message below appears.	This message appears when the signal is not input correctly even when the monitor functions properly.
Example: <div data-bbox="395 1151 639 1240" style="border: 1px solid black; background-color: #cccccc; padding: 5px; margin: 10px auto; width: fit-content;"> PC2 (D-SUB) Signal Error </div>	<ul style="list-style-type: none"> The message shows that the input signal is out of the specified range. When the analog signal (D-Sub)/ digital signal (DVI-D, HDMI: PC signal) is input, take the measures below: <ul style="list-style-type: none"> Check whether the PC is configured to meet the resolution and vertical scan frequency requirements of the monitor (see “2-1. Compatible Resolutions/Formats” (page 13)). Reboot the PC. Select an appropriate display mode using the graphics board’s utility. Refer to the manual of the graphics board for details.



Imaging problems (for both digital and analog)

Problem	Possible cause and remedy
3. The screen is too bright or too dark.	<ul style="list-style-type: none"> Use “Brightness” or “Contrast” in the Setting menu to adjust it. (The LCD monitor backlight has a limited life span. When the screen becomes dark or begins to flicker, contact your local dealer.) Turn on the Auto EcoView function. The monitor detects the environmental brightness to adjust the screen brightness automatically.
4. Characters are blurred.	<ul style="list-style-type: none"> Check whether the PC is configured to meet the resolution and vertical scan frequency requirements of the monitor (see “2-1. Compatible Resolutions/Formats” (page 13)). Use “Smoothing” in the Setting menu to adjust it (see “To modify blurred characters/lines “Smoothing”” (page 27)).
5. Afterimages appear.	<ul style="list-style-type: none"> Afterimages are particular to LCD monitors. Avoid displaying the same image for a long time. Use the screen saver or power save function to avoid displaying the same image for extended periods of time.
6. Green/red/blue/white dots or defective dots remain on the screen.	<ul style="list-style-type: none"> This is due to LCD panel characteristics and is not a failure.
7. Interference patterns or pressure marks remain on the screen.	<ul style="list-style-type: none"> Leave the monitor with a white or black screen. The symptom may disappear.
8. Noise appears on the screen.	<ul style="list-style-type: none"> In the Setting menu, set “Overdrive” to “Off” (see “To set overdrive intensity “Overdrive”” (page 23)). When entering the signals of HDCP system, the normal images may not be displayed immediately.
9. The screen is whitish or blackish.	<ul style="list-style-type: none"> Use “Color Space” of the “Screen” submenu (for the HDMI input), “Black Level” (see “To adjust black level “Black Level”” (page 17)), and “Contrast” (see “To adjust contrast “Contrast”” (page 17)) in the Setting menu to adjust it.

Imaging problems (for digital only)

Problem	Possible cause and remedy
10. The color shown on the display is not correct (for HDMI input).	<ul style="list-style-type: none"> Change the color space of the video signal in “Screen” - “Color Space” under the Setting menu.
11. The screen flashes (for HDMI input)	<ul style="list-style-type: none"> Transmittable signals differ on the category of the HDMI cable. Check whether the cable support High Speed.

Imaging problems (for analog only)

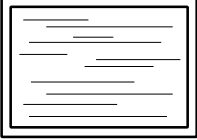
Problem	Possible cause and remedy
<p>12. Display position is incorrect.</p> 	<ul style="list-style-type: none">• Use “Position” in the Setting menu to correct the image position (see “To correct the screen position “Position”” (page 26)).• If the problem persists, use the graphics board’s utility if available to change the display position.
<p>13. Vertical bars appear on the screen or a part of the image is flickering.</p> 	<ul style="list-style-type: none">• Use “Clock” in the Setting menu to adjust it (see “To eliminate vertical bars “Clock”” (page 25)).
<p>14. Whole screen is flickering or blurring.</p> 	<ul style="list-style-type: none">• Use “Phase” in the Setting menu to adjust it (see “To remove flickering or blurring “Phase”” (page 25)).

Other problems

Problem	Possible cause and remedy
15. The “Smoothing” on the Setting menu “Screen” cannot be selected.	<ul style="list-style-type: none"> • You cannot choose “smoothing” when the screen is displayed in the following resolutions or settings. <ul style="list-style-type: none"> - The resolution is 1920 × 1080 - Screen Size is “Normal”
16. The auto adjustment function does not work.	<ul style="list-style-type: none"> • This function does not work during digital signal input. • This function is intended for use on the Macintosh and on AT-compatible PC running Windows. It does not work properly when an image is displayed only on a part of the screen (command prompt window, for example) or when a black background (wallpaper, etc.) is in use. • This function does not work correctly with some graphics boards.
17. No audio output.	<ul style="list-style-type: none"> • Check whether the stereo mini jack cable is connected properly. • Check whether volume is set to 0. • Check the current external device and audio playback software to see whether they are configured correctly. • If HDMI input is used, check the current external device and the “Source” setting in the Setting menu (see “3-2. Switching sound source for HDMI signal input “Source” (page 29)).
18. “ScreenManager Pro for LCD (DDC/CI)” does not run.	<ul style="list-style-type: none"> • “ScreenManager Pro for LCD (DDC/CI)” does not run when a PC is connected to the HDMI input. • Check the setting for “DDC/CI” in the Setting menu. (see “3-4. Enabling/Disabling DDC/CI communication “DDC/CI” (page 30)). • During the demo mode of “Smart Resolution”, the DDC/CI communication is disabled. “ScreenManager Pro for LCD (DDC/CI)” does not run.
19. Will not change to the power saving mode	<ul style="list-style-type: none"> • When all the conditions below are met, the monitor does not change to the power saving mode even if “Power Save” is set to “Enable”: <ul style="list-style-type: none"> - “Power Save” for Sound is set to “Sound On” (“Audio Output” (page 34)) - In the mute state (“To mute the sound temporarily” (page 29)) <p>In these cases, reset the mute.</p>

Chapter 7 Reference

7-1. How to Attach the Optional Arm

An optional arm (or an optional stand) can be attached by removing the stand section. Please refer to our web site for the corresponding optional arm (or optional stand). <http://www.eizo.com>

Attention

- When attaching an arm or stand, follow the instructions of their user's manual.
- When using another manufacturer's arm or stand, confirm the following in advance and select one conforming to the VESA standard. Use the M4 × 12 mm screws supplied with this product.
 - Clearance between the screw holes: 100 mm × 100 mm
 - Thickness of plate: 2.6 mm
 - Strong enough to support weight of the monitor unit (except the stand) and attachments such as cables.
- When using an arm or stand, attach it to meet the following tilt angles of the monitor.
 - Up 45°, down 45° (horizontal display, and vertical display rotated 90 degrees clockwise)
- Connect the cables after attaching an arm or stand.
- The monitor and arm or stand are heavy. Dropping them may result in injury or equipment damage.

Procedure

1. Lay the LCD monitor on a soft cloth spread over on a stable surface with the panel surface facing down.

2. Remove the Stand base.

Turn the fixing screws for the Stand base to detach it.

3. Attach the arm or stand to the monitor.

Secure the monitor to the arm or stand using the screws specified in the user's manual of the arm or stand.

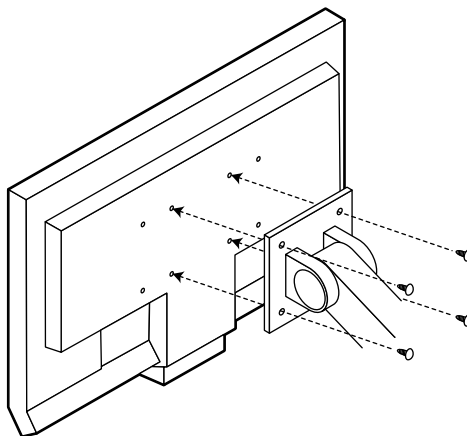

7-2. Attaching the Stand base

The once removed the Stand base can be attached to the monitor again with the following procedures.

Procedure

1. Lay the LCD monitor on a soft cloth spread over on a stable surface with the panel surface facing down.
2. Attach the Stand base.

Hold the Stand base with the arrow “↑” facing upward, align the two holes (a) of the Stand base with the two tabs (b) at the bottom of the monitor, and snap the tabs into the holes.

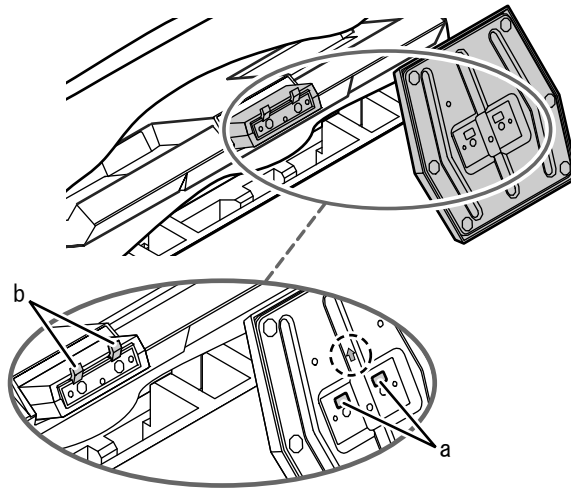

3. Turn the supplied screw in the “LOCK” direction to lock the Stand base.

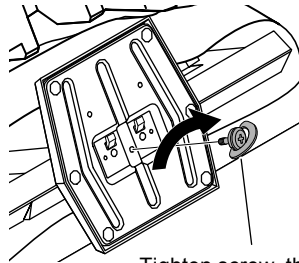

Tighten screw, then press knob flat.

7-3. Displaying Monitor Information “Information”

This function allows you to display the model name, serial number, usage time, resolution, and input signal.

Procedure

1. Choose “Information” in the Setting menu, and press .
The “Information” menu appears.

Attention

- The usage time is not always “0” when you purchase the monitor due to factory inspection.

7-4. Specifications

LCD Panel	Size		23.0-inch (580 mm)
	Type		TFT color LCD, IPS
	Surface treatment		Anti-Glare Hard Coating
	Surface hardness		3H
	Viewing angles		Viewing angles: Horizontal 178°, vertical 178° (CR≥10)
	Dot Pitch		0.2655mm
	Response Time		Black-white-black: Approx. 16 ms Gray-to-gray: Approx. 6 ms (Overdrive setting: Enhanced)
	Contrast ratio		1000:1 (when Contrast Enhancer setting is "On" 1500:1)
Horizontal Scan Frequency	Analog		31-81 kHz
	Digital	DVI	31-68 kHz
		HDMI	31-68 kHz
Vertical Scan Frequency	Analog		55-76 Hz (non-interlace)
	Digital	DVI	59-61 Hz (non-interlace) (VGA TEXT: 69-71 Hz)
		HDMI	49-61 Hz (VGA TEXT: 69-71 Hz)
Applicable video signal formats			VGA / 525p (480p)/750p (720p)/1125p (1080p): 60 Hz 625p (576p)/750p (720p)/1125p (1080p): 50 Hz
Applicable audio signal formats			2ch linear PCM (32 kHz/44.1 kHz/48 kHz)
Resolution			1920 Dots × 1080 Lines
Max. Dot Clock			148.5 MHz
Max. Display Color			Approx. 16.77 million colors (1064.33 million colors/10bit LUT)
Display Area (H × V)			509.76 mm × 286.74 mm (20.1 inch × 11.3 inch)
Power Supply			100-120 VAC ±10%, 50/60 Hz 0.6 A 200-240 VAC ±10%, 50/60 Hz 0.36 A
Power Consumption	Screen Display On		34 W or less
	Power saving mode		1.0 W or less (for D-Sub single signal input, when stereo mini jack cable is not connected)
	Power Off		0.17 W or less
	Main Power Off		0 W
Input Signal Connector			D-Sub mini 15-pin
			DVI-D connector (Applicable to HDCP)
			HDMI Type A* × 2
Analog Input Signal (Sync)			Separate, TTL, positive/ negative
Analog Input Signal (Video)			Analog, Positive (0.7Vp-p/75Ω)
Digital Signal Transmission			TMDS (Single Link)
Audio Output			Speaker output: 0.5 W + 0.5 W (8Ω, THD+N: 1% or less) Headphone output: 2 mW + 2 mW
Line Input			Input impedance: 44 kΩ (typ.) Input level: 2.0 Vrms (Max.)
Plug & Play			VESA DDC 2B/EDID structure 1.3
Dimensions (Width) × (Height) × (Depth)	Main unit		549 mm (21.6 inch) × 403 mm (15.9 inch) × 212 mm (8.3 inch)
	Main unit (without stand)		549 mm (21.6 inch) × 393 mm (15.5 inch) × 58 mm (2.28 inch)
Mass	Main unit		Approx. 6.2 kg (13.7 lbs.)
	Main unit (without stand)		Approx. 5.4 kg (11.9 lbs.)
Movable range			Tilt: 20° Up, 5° Down

* HDMI CEC (or mutual control) is not supported.

Environmental Conditions	Temperature	Operating: 5°C to 35°C (41°F to 95°F) Storage: -20°C to 60°C (-4°F to 140°F)
	Humidity	Operating: 20% to 80% R.H. (no condensation) Storage: 10% to 90% R.H. (no condensation)
	Air Pressure	Operating: 700 to 1,060 hPa Storage: 200 to 1,060 hPa

Main Default Settings

Color Mode	D-Sub/DVI-D input: User1 HDMI input: Game
Off Timer	Disable
Screen Size	D-Sub/DVI-D input: Full screen HDMI (PC signal/HD signal) input: Full screen HDMI (SD signal) input: Auto
Auto EcoView	On
Smoothing	3
Sound Level	0
Sound - Power Save	Sound Off
PowerManager - Power Save	Enable
DDC/CI	Enable
Key Lock	Off
Logo	On
Power Indicator	Enable
Language	English

Outside Dimensions

Unit: mm (inch)

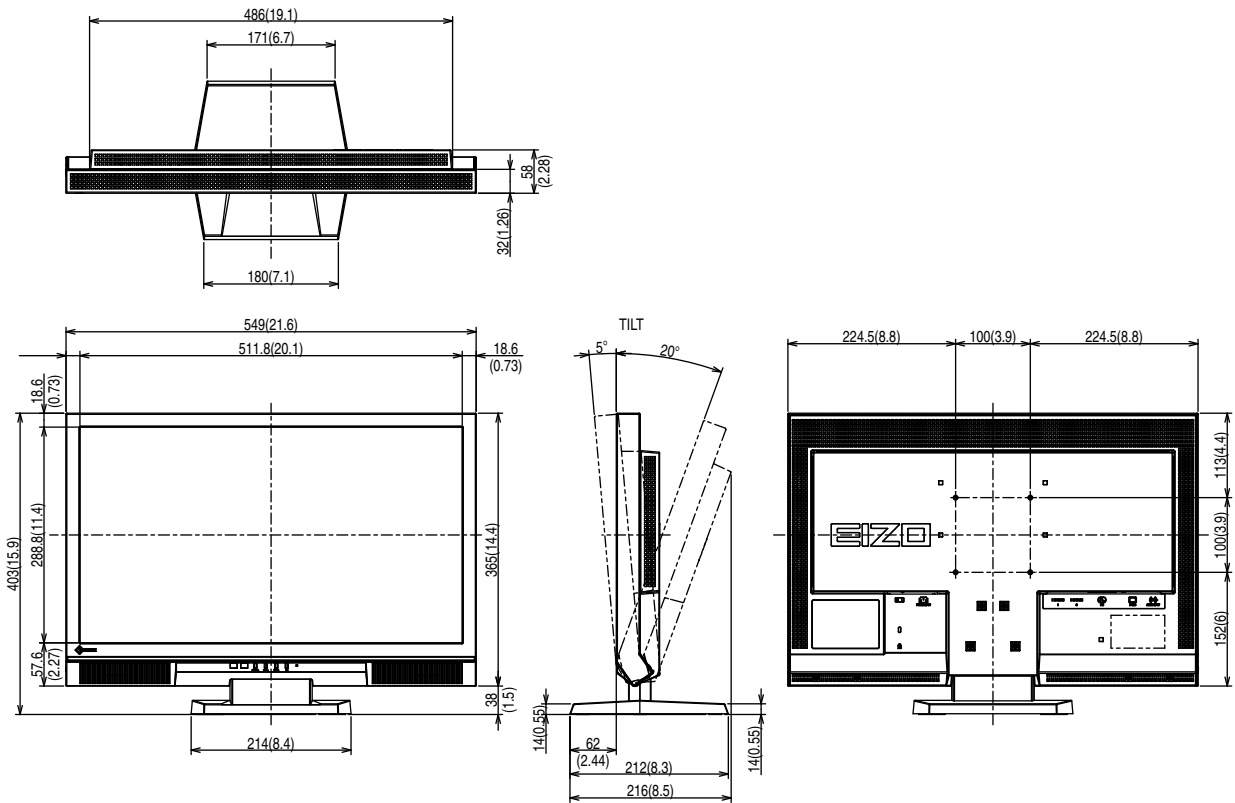

Accessories

Cleaning Kit	EIZO "ScreenCleaner"
Signal cable (D-Sub mini 15-pin)	MD-C87

For the latest information about the accessories, refer to our web site.

<http://www.eizo.com>

7-5. Glossary

Clock

The analog signal input monitor needs to reproduce a clock of the same frequency as the dot clock of the graphics system in use, when the analog signal is converted to a digital signal for image display. This is called clock adjustment. If the clock pulse is not set correctly, some vertical bars appear on the screen.

Color Space

Color space is a method to specify and express the color. There are YUV and RGB, etc. YUV expresses the color by using the luminance (Y), the color difference of R (U) and the color difference of blue (V). RGB does it by using the gradation of 3 colors of Red (R), Green (G) and Blue (B).

DDC/CI (Display Data Channel/Command Interface)

VESA provides the standardization for the interactive communication of the setting information, etc. between a PC and the monitor.

DVI (Digital Visual Interface)

DVI is a digital interface standard. DVI allows direct transmission of the PC's digital data without loss. This adopts the TMDS transmission system and DVI connectors. There are two types of DVI connectors. One is a DVI-D connector for digital signal input only. The other is a DVI-I connector for both digital and analog signal inputs.

DVI DMPM (DVI Digital Monitor Power Management)

DVI DMPM is a digital interface power-saving function. The "Monitor ON (operating mode)" and "Active Off (power-saving mode)" are indispensable for DVI DMPM as the monitor's power mode.

Gain

This is used to adjust each color parameter for red, green and blue. An LCD monitor displays the color by the light passing through the panel color filter. Red, green and blue are the three primary colors. All the colors on the screen are displayed by combining these three colors. The color tone can be changed by adjusting the light intensity (volume) passing through each color's filter.

Gamma

Generally, the monitor brightness varies nonlinearly with the input signal level, which is called "Gamma Characteristic". A small gamma value produces a low-contrast image, while a large gamma value produces a high-contrast image.

HDCP (High-bandwidth Digital Content Protection)

Digital signal coding system developed to copy-protect the digital contents, such as video, music, etc. This helps to transmit the digital contents safely by coding the digital contents sent via the DVI or HDMI connector on the output side and decoding them on the input side. Any digital contents cannot be reproduced if both of the equipments on the output and input sides are not applicable to HDCP system.

HDMI (High-Definition Multimedia Interface)

HDMI is a digital interface standard, developed for consumer electrical appliance or AV device. This standard is issued on the basis of the DVI standard which is one of an interface specification for the connection between a PC and a monitor. The projected image, sound and control signal without compressed enable to be transmitted with one cable.

Overdrive

This technology enhances response speed by increasing the potential difference at the time of motion of liquid-crystal pixels, and it is used for liquid-crystal TV sets and others in general. It provides clear-cut three-dimensional display with little image lag, by improving response speed of the intermediate graduation range that frequently appears in moving images.

Phase

Phase means the sampling timing to convert the analog input signal to a digital signal. Phase adjustment is made to adjust the timing. It is recommended that phase adjustment be made after the clock is adjusted correctly.

Range Adjustment

Range adjustment controls the signal output levels to display every color gradation. It is recommended that range adjustment be made before color adjustment.

Resolution

The LCD panel consists of numerous pixels of specified size, which are illuminated to form images. This monitor consists of 1920 horizontal pixels and 1080 vertical pixels. At a resolution of 1920×1080 , all pixels are illuminated as a full screen (1:1).

sRGB (Standard RGB)

International standard for color reproduction and color space among peripheral devices (such as monitors, printers, digital cameras, scanners). As a form of simple color matching for the Internet, colors can be displayed using tones close to those of the transmission and reception devices.

Temperature

Color temperature is a method to measure the white color tone, generally indicated in degrees Kelvin. The screen becomes reddish at a low temperature, and bluish at a high temperature, like the flame temperature.

5000K: Slightly reddish white

6500K: White referred to as daylight-balanced color

9300K: Slightly bluish white

TMDS (Transition Minimized Differential Signaling)

TMDS is one of the signal transmission methods for the digital interface.

VESA DPM (Video Electronics Standards Association - Display Power Management)

VESA specifications achieve increased energy efficiency for computer monitors. This involves standardization of signals sent from the computer (graphics board).

DPM defines the status of signals transmitted between the computer and monitor.

7-6. Preset Timing

The following table shows factory preset analog signal timing:

Attention

- Display position may be deviated depending on the PC connected, which may require screen adjustment using Setting menu.
- If a signal other than those listed in the table is input, adjust the screen using the Setting menu. However, screen display may still be incorrect even after the adjustment.
- When interlace signals are used, the screen cannot be displayed correctly even after screen adjustment using the Setting menu.

Resolution	Applicable Signals	Frequency			Polarity	
		Dot Clock: MHz	Horizontal: kHz	Vertical: Hz	Horizontal	Vertical
640 × 480	VGA/CEA-861	25.18	31.47	59.94	Negative	Negative
720 × 400	VGA TEXT	28.32	31.47	70.09	Negative	Positive
640 × 480	VESA	31.50	37.50	75.00	Negative	Negative
800 × 600	VESA	40.00	37.88	60.32	Positive	Positive
800 × 600	VESA	49.50	46.88	75.00	Positive	Positive
1024 × 768	VESA	65.00	48.36	60.00	Negative	Negative
1024 × 768	VESA	78.75	60.02	75.03	Positive	Positive
1280 × 720	CEA-861	74.25	45.00	60.00	Positive	Positive
1280 × 960	VESA	108.00	60.00	60.00	Positive	Positive
1280 × 1024	VESA	108.00	63.98	60.02	Positive	Positive
1280 × 1024	VESA	135.00	79.98	75.03	Positive	Positive
1680 × 1050	VESA CVT	146.25	65.29	59.95	Negative	Positive
1680 × 1050	VESA CVT RB	119.00	64.67	59.88	Positive	Negative
1920 × 1080	CEA-861	148.50	67.50	60.00	Positive	Positive

Appendix

Trademark

VESA is a registered trademark or a trademark of the Video Electronics Standards Association in the United States and other countries.

Windows, Windows Vista, Windows Media, and Xbox 360 are registered trademarks of Microsoft Corporation in the United States and other countries.

Apple, Mac, Macintosh, iMac, eMac, Mac OS, MacBook, PowerBook, ColorSync, QuickTime, and iBook are registered trademarks of Apple Inc.

Acrobat, Adobe, Adobe AIR, and Photoshop are registered trademarks of Adobe Systems Incorporated in the United States and other countries.

PowerPC is a registered trademark of International Business Machines Corporation.

Pentium is a registered trademark of Intel Corporation in the United States and other countries.

AMD Athlon and AMD Opteron are trademarks of Advanced Micro Devices, Inc.

GRACoL and IDEAlliance are registered trademarks of International Digital Enterprise Alliance.

ColorVision, ColorVision Spyder2 are registered trademarks of DataColor Holding AG.

Spyder3 is a trademark of DataColor Holding AG.

Eye-One, ColorMunki, and X-Rite are registered trademarks or trademarks of X-Rite Incorporated.

TouchWare is a trademark of 3M Touch Systems, Inc.

NextWindow is a registered trademark of NextWindow Ltd.

RealPlayer is a registered trademark of RealNetworks, Inc.

NEC is a registered trademark of NEC Corporation. PC-9801 and PC-9821 are trademarks of NEC Corporation.

PlayStation is a registered trademark of Sony Computer Entertainment Inc.

PSP and PS3 are trademarks of Sony Computer Entertainment Inc.

ENERGY STAR is a registered trademark of the United States Environmental Protection Agency in the United States and other countries.

HDMI, the HDMI logo, and High-Definition Multimedia Interface are trademarks or registered trademarks of HDMI Licensing, LLC in the United States and other countries.

EIZO, the EIZO Logo, ColorEdge, DuraVision, FlexScan, FORIS, RadiForce, RadiCS, RadiNET, Raptor, and ScreenManager are registered trademarks of EIZO NANA O CORPORATION in Japan and other countries.

ColorNavigator, EIZO EasyPIX, EcoView NET, EIZO ScreenSlicer, i•Sound, Screen Administrator, and UniColor Pro are trademarks of EIZO NANA O CORPORATION.

All other company and product names are trademarks or registered trademarks of their respective owners.

License

The round gothic bold bit map font used for the characters displayed on this product is designed by Ricoh.

ENERGY STAR

As an ENERGY STAR Partner, EIZO NANA O CORPORATION has determined that this product meets the ENERGY STAR guidelines for energy efficiency.



TCO

This product has acquired TCO standard that relates to safety, ergonomics, environment and so forth of office equipment. For overview of the TCO, refer to our website.

<http://www.eizo.com>

FCC Declaration of Conformity

For U.S.A. , Canada, etc. (rated 100-120 Vac) Only

FCC Declaration of Conformity

We, the Responsible Party

EIZO NANAOTECHNOLOGIES INC.

5710 Warland Drive, Cypress, CA 90630

Phone: (562) 431-5011

declare that the product

Trade name: EIZO

Model: FORIS FS2332

is in conformity with Part 15 of the FCC Rules. Operation of this product is subject to the following two conditions: (1) this device may not cause harmful interference, and (2) this device must accept any interference received, including interference that may cause undesired operation.

This equipment has been tested and found to comply with the limits for a Class B digital device, pursuant to Part 15 of the FCC Rules. These limits are designed to provide reasonable protection against harmful interference in a residential installation. This equipment generates, uses, and can radiate radio frequency energy and, if not installed and used in accordance with the instructions, may cause harmful interference to radio communications. However, there is no guarantee that interference will not occur in a particular installation. If this equipment does cause harmful interference to radio or television reception, which can be determined by turning the equipment off and on, the user is encouraged to try to correct the interference by one or more of the following measures.

- * Reorient or relocate the receiving antenna.
- * Increase the separation between the equipment and receiver.
- * Connect the equipment into an outlet on a circuit different from that to which the receiver is connected.
- * Consult the dealer or an experienced radio/TV technician for help.

Changes or modifications not expressly approved by the party responsible for compliance could void the user's authority to operate the equipment.

Note

Use the attached specified cable below or EIZO signal cable with this monitor so as to keep interference within the limits of a Class B digital device.

- AC Cord
- Shielded Signal Cable (Enclosed)

Canadian Notice

This Class B digital apparatus complies with Canadian ICES-003.

Cet appareil numérique de la classe B est conforme à la norme NMB-003 du Canada.

Hinweise zur Auswahl des richtigen Schwenkarms für Ihren Monitor

Dieser Monitor ist für Bildschirmarbeitsplätze vorgesehen. Wenn nicht der zum Standardzubehör gehörige Schwenkarm verwendet wird, muss statt dessen ein geeigneter anderer Schwenkarm installiert werden. Bei der Auswahl des Schwenkarms sind die nachstehenden Hinweise zu berücksichtigen:

Der Standfuß muß den nachfolgenden Anforderungen entsprechen:

- a) Der Standfuß muß eine ausreichende mechanische Stabilität zur Aufnahme des Gewichtes vom Bildschirmgerät und des spezifizierten Zubehörs besitzen. Das Gewicht des Bildschirmgerätes und des Zubehörs sind in der zugehörigen Bedienungsanleitung angegeben.
- b) Die Befestigung des Standfusses muß derart erfolgen, daß die oberste Zeile der Bildschirmanzeige nicht höher als die Augenhöhe eines Benutzers in sitzender Position ist.
- c) Im Fall eines stehenden Benutzers muß die Befestigung des Bildschirmgerätes derart erfolgen, daß die Höhe der Bildschirmmitte über dem Boden zwischen 135 – 150 cm beträgt.
- d) Der Standfuß muß die Möglichkeit zur Neigung des Bildschirmgerätes besitzen (max. vorwärts: 5°, min. nach hinten $\geq 5^\circ$).
- e) Der Standfuß muß die Möglichkeit zur Drehung des Bildschirmgerätes besitzen (max. $\pm 180^\circ$). Der maximale Kraftaufwand dafür muß weniger als 100 N betragen.
- f) Der Standfuß muß in der Stellung verharren, in die er manuell bewegt wurde.
- g) Der Glanzgrad des Standfusses muß weniger als 20 Glanzeinheiten betragen (seidenmatt).
- h) Der Standfuß mit Bildschirmgerät muß bei einer Neigung von bis zu 10° aus der normalen aufrechten Position kippsicher sein.

Hinweis zur Ergonomie :

Dieser Monitor erfüllt die Anforderungen an die Ergonomie nach EK1-ITB2000 mit dem Videosignal, 1920 × 1080, Digital Eingang und mindestens 60,0 Hz Bildwiederholfrequenz, non interlaced. Weiterhin wird aus ergonomischen Gründen empfohlen, die Grundfarbe Blau nicht auf dunklem Untergrund zu verwenden (schlechte Erkennbarkeit, Augenbelastung bei zu geringem Zeichenkontrast.)

Übermäßiger Schalldruck von Ohrhörern bzw. Kopfhörern kann einen Hörverlust bewirken. Eine Einstellung des Equalizers auf Maximalwerte erhöht die Ausgangsspannung am Ohrhörer- bzw. Kopfhörerausgang und damit auch den Schalldruckpegel.

„Maschinenlärminformations-Verordnung 3. GPSGV:

Der höchste Schalldruckpegel beträgt 70 dB(A) oder weniger gemäss EN ISO 7779“

[Begrenzung des maximalen Schalldruckpegels am Ohr]
Bildschirmgeräte: Größte Ausgangsspannung 150 mV

LIMITED WARRANTY

LIMITED WARRANTY

EIZO NANO CORPORATION (hereinafter referred to as “EIZO”) and distributors authorized by EIZO (hereinafter referred to as the “Distributors”) warrant, subject to and in accordance with the terms of this limited warranty (hereinafter referred to as the “Warranty”), to the original purchaser (hereinafter referred to as the “Original Purchaser”) who purchased the product specified in this document (hereinafter referred to as the “Product”) from EIZO or Distributors, that EIZO and Distributors shall, at their sole discretion, either repair or replace the Product at no charge if the Original Purchaser becomes aware within the Warranty Period (defined below) that the Product malfunctions or is damaged in the course of normal use of the Product in accordance with the description in the instruction manual attached to the Product (hereinafter referred to as the “User’s Manual”).

The period of this Warranty is limited to (i) five (5) years from the date of purchase of the Product; or, limited to the expiration of (ii) 30,000 hours of its use of the Product (hereinafter referred to as the “Warranty Period”); provided, however, that the Warranty Period for the LCD panel of the Product is limited to three (3) years from the date of purchase of the Product. EIZO and Distributors shall bear no liability or obligation with regard to the Product in relation to the Original Purchaser or any third parties other than as provided under this Warranty.

EIZO and Distributors will cease to hold or store any parts of the Product upon expiration of seven (7) years after the production of such parts is discontinued. In repairing the monitor, EIZO and Distributors will use renewal parts which comply with our QC standards.

The Warranty is valid only in the countries or territories where the Distributors are located. The Warranty does not restrict any legal rights of the Original Purchaser.

Notwithstanding any other provision of this Warranty, EIZO and Distributors shall have no obligation under this Warranty whatsoever in any of the cases as set forth below:

- (a) Any defect of the Product caused by freight damage, modification, alteration, abuse, misuse, accident, incorrect installation, disaster, faulty maintenance and/or improper repair by third party other than EIZO and Distributors;
- (b) Any incompatibility of the Product due to possible technical innovations and/or regulations;
- (c) Any deterioration of the sensor;
- (d) Any deterioration of display performance caused by the deterioration of expendable parts such as the LCD panel and/or backlight, etc. (e.g. changes in brightness, changes in brightness uniformity, changes in color, changes in color uniformity, defects in pixels including burnt pixels, etc.);
- (e) Any defect of the Product caused by external equipment;
- (f) Any defect of the Product on which the original serial number has been altered or removed;
- (g) Any defect of the Product caused by liquid leaking from battery;
- (h) Any normal deterioration of the product, particularly that of consumables, accessories, and/or attachments (e.g. batteries, buttons, rotating parts, remote control, cables, User’s Manual, etc.); and
- (i) Any deformation, discoloration, and/or warp of the exterior of the product including that of the surface of the LCD panel.

To obtain service under the Warranty, the Original Purchaser must deliver the Product, freight prepaid, in its original package or other adequate package affording an equal degree of protection, assuming the risk of damage and/or loss in transit, to the local Distributor. The Original Purchaser must present proof of purchase of the Product and the date of such purchase when requesting services under the Warranty.

The Warranty Period for any replaced and/or repaired product under this Warranty shall expire at the end of the original Warranty Period.

EIZO OR DISTRIBUTORS ARE NOT RESPONSIBLE FOR ANY DAMAGE TO, OR LOSS OF, DATA OR OTHER INFORMATION STORED IN ANY MEDIA OR ANY PART OF ANY PRODUCT RETURNED TO EIZO OR DISTRIBUTORS FOR REPAIR.

EIZO AND DISTRIBUTORS MAKE NO FURTHER WARRANTIES, EXPRESSED OR IMPLIED, WITH RESPECT TO THE PRODUCT AND ITS QUALITY, PERFORMANCE, MERCHANTABILITY OR FITNESS FOR ANY PARTICULAR USE. IN NO EVENT SHALL EIZO OR DISTRIBUTORS BE LIABLE FOR ANY INCIDENTAL, INDIRECT, SPECIAL, CONSEQUENTIAL OR OTHER DAMAGE WHATSOEVER (INCLUDING, WITHOUT LIMITATION, DAMAGES FOR LOSS OF PROFIT, BUSINESS INTERRUPTION, LOSS OF BUSINESS INFORMATION, OR ANY OTHER PECUNIARY LOSS) ARISING OUT OF THE USE OR INABILITY TO USE THE PRODUCT OR IN ANY CONNECTION WITH THE PRODUCT, WHETHER BASED ON CONTRACT, TORT, NEGLIGENCE, STRICT LIABILITY OR OTHERWISE, EVEN IF EIZO OR DISTRIBUTORS HAVE BEEN ADVISED OF THE POSSIBILITY OF SUCH DAMAGES. THIS EXCLUSION ALSO INCLUDES ANY LIABILITY WHICH MAY ARISE OUT OF THIRD PARTY CLAIMS AGAINST THE ORIGINAL PURCHASER. THE ESSENCE OF THIS PROVISION IS TO LIMIT THE POTENTIAL LIABILITY OF EIZO AND DISTRIBUTORS ARISING OUT OF THIS LIMITED WARRANTY AND/OR SALES.

BEGRENZTE GARANTIE

EIZO NANO CORPORATION (im Weiteren als „EIZO“ bezeichnet) und die Vertragsimporteure von EIZO (im Weiteren als „Vertrieb(e)“ bezeichnet) garantieren dem ursprünglichen Käufer (im Weiteren als „Erstkäufer“ bezeichnet), der das in diesem Dokument vorgegebene Produkt (im Weiteren als „Produkt“ bezeichnet) von EIZO oder einem Vertrieb erworben hat, gemäß den Bedingungen dieser beschränkten Garantie (im Weiteren als „Garantie“ bezeichnet), dass EIZO und der Vertrieb nach eigenem Ermessen das Produkt entweder kostenlos reparieren oder austauschen, falls der Erstkäufer innerhalb der Garantiefrist (weiter unten festgelegt) eine Fehlfunktion bzw. Beschädigung des Produkts feststellt, die während des normalen Gebrauchs des Produkts gemäß den Anweisungen des zum Lieferumfang des Produkts gehörenden Benutzerhandbuchs (im Weiteren als „Benutzerhandbuch“ bezeichnet) aufgetreten ist.

Die Dauer der Garantieleistung beträgt (i) fünf (5) Jahre ab dem Erstverkaufsdatum des Produkts oder (ii) 30.000 Betriebsstunden des Produkts (im Weiteren als „Garantiefrist“ bezeichnet); die Garantiefrist für das LCD-Panel des Produkts ist jedoch auf drei (3) Jahre ab dem Erstverkaufsdatum des Produkts beschränkt. EIZO und die Vertriebe übernehmen über den Rahmen dieser Garantie hinaus hinsichtlich des Produkts keinerlei Haftung oder Verpflichtung dem Erstkäufer oder Dritten gegenüber.

EIZO und die Vertriebe verpflichten sich, Ersatzteile für das Produkt über einen Zeitraum von sieben (7) Jahren nach Einstellung der Produktion der Ersatzteile zu lagern bzw. anzubieten. EIZO und seine Vertriebspartner verpflichten sich, bei einer etwaigen Reparatur des Monitors ausschließlich Produkte gemäß den EIZO-Qualitätssicherungsstandards zu verwenden.

Diese Garantie gilt nur in Ländern oder Gebieten, in denen sich Vertriebe befinden. Die gesetzlichen Gewährleistungsrechte des Erstkäufers gegenüber dem Verkäufer werden durch diese Garantie nicht berührt.

EIZO und die Vertriebe besitzen im Rahmen dieser Garantie keinerlei Verpflichtung in den folgenden Fällen:

- (a) Produktdefekte, die auf Frachtschäden, Modifikation, Nachgestaltung, Missbrauch, Fehlbedienung, Unfälle, unsachgemäße Installation, Naturkatastrophen, fehlerhafte Wartung und/oder unsachgemäße Reparatur durch eine andere Partei als EIZO und die Vertriebe zurückzuführen sind.
- (b) Eine Inkompatibilität des Produkts aufgrund von technischen Neuerungen und/oder neuen Bestimmungen, die nach dem Kauf in Kraft treten.
- (c) Jegliche Verschlechterung des Sensors.
- (d) Jegliche Verschlechterung der Bildschirmleistung, die durch Verschleißteile wie das LCD-Panel und/oder die Hintergrundbeleuchtung usw. hervorgerufen werden (z.B. Veränderungen von Helligkeit oder Helligkeitsverteilung, Veränderungen von Farbe oder Farbverteilung, Pixeldefekte einschließlich von durchgebrannten Pixeln usw.).
- (e) Produktdefekte, die durch externe Geräte verursacht werden.
- (f) Jeglicher Defekt eines Produkts, dessen ursprüngliche Seriennummer geändert oder entfernt wurde.
- (g) Produktdefekte, die durch Austritt von Batterieflüssigkeit verursacht werden.
- (h) Normale Abnutzung des Produkts, insbesondere von Verbrauchsteilen, Zubehörteilen und/oder Beilagen (z.B. Batterien, Tasten, drehbare Teile, Fernbedienung, Kabel, Benutzerhandbuch usw.); sowie
- (i) Verformungen, Verfärbungen und/oder Verziehungen am Produktäußeren, einschließlich der Oberfläche des LCD-Panels.

Bei Inanspruchnahme der Garantieleistung ist der Erstkäufer verpflichtet, das Produkt auf eigene Kosten und in der Originalverpackung bzw. einer anderen geeigneten Verpackung, die einen gleichwertigen Schutz gegen Transportschäden bietet, an den örtlichen Vertrieb zu übersenden, wobei der Erstkäufer das Transportrisiko gegenüber Schäden und/oder Verlust trägt. Zum Zeitpunkt der Inanspruchnahme der Garantieleistung muss der Erstkäufer einen Verkaufsbeleg vorweisen, auf dem das Kaufdatum angegeben ist.

Die Garantiefrist für ein im Rahmen dieser Garantie ausgetauschtes und/oder repariertes Produkt erlischt nach Ablauf der ursprünglichen Garantiefrist.

EIZO ODER DIE EIZO-VERTRAGSIMPORTEURE HAFTEN NICHT FÜR ZERSTÖRTE DATENBESTÄNDE ODER DIE KOSTEN DER WIEDERBESCHAFFUNG DIESER DATENBESTÄNDE AUF JEDLICHEN DATENTRÄGERN ODER TEILEN DES PRODUKTS, DIE IM RAHMEN DER GARANTIE BEI EIZO ODER DEN EIZO-VERTRAGSIMPORTEUREN ZUR REPARATUR EINGEREICHT WURDEN.

EIZO UND DIE EIZO-VERTRAGSIMPORTEURE GEBEN WEDER EXPLIZITE NOCH IMPLIZITE GARANTIEEN IN BEZUG AUF DIESES PRODUKT UND SEINE QUALITÄT, LEISTUNG, VERKÄUFLICHKEIT ODER EIGNUNG FÜR EINEN BESTIMMTEN ZWECK. AUF KEINEN FALL SIND EIZO ODER DIE EIZO-VERTRAGSIMPORTEURE VERANTWORTLICH FÜR JEDLICHE ZUFÄLLIGE, INDIREKTE, SPEZIELLE, FOLGE- ODER ANDERE SCHÄDEN JEDLICHER ART (EINSCHLIESSLICH OHNE JEDE BEGRENZUNG SCHÄDEN BEZÜGLICH PROFITVERLUST, GESCHÄFTSUNTERBRECHUNG, VERLUST VON GESCHÄFTSINFORMATION ODER JEDLICHE ANDEREN FINANZIELLEN EINBUSSEN), DIE DURCH DIE VERWENDUNG DES PRODUKTES ODER DIE UNFÄHIGKEIT ZUR VERWENDUNG DES PRODUKTES ODER IN JEDLICHER BEZIEHUNG MIT DEM PRODUKT, SEI ES BASIEREND AUF VERTRAG, SCHADENSERSATZ, NACHLAESSIGKEIT, STRIKTE HAFTPFLICHT ODER ANDEREN FORDERUNGEN ENTSTEHEN, AUCH WENN EIZO UND DIE EIZO-VERTRAGSIMPORTEURE IM VORAUS ÜBER DIE MÖGLICHKEIT SOLCHER SCHÄDEN INFORMIERT WURDEN. DIESER AUSSCHLUSS ENTHÄLT AUCH JEDE HAFTPFLICHT, DIE AUS FORDERUNGEN DRITTER GEGEN DEN ERSTKÄUFER ENTSTEHEN KANN. ZWECK DIESER KLAUSEL IST ES, DIE HAFTUNG VON EIZO UND DEN VERTRIEBEN GEGENÜBER FORDERUNGEN ZU BEGRENZEN, DIE AUS DIESER BESCHRÄNKTEN GARANTIE UND/ODER DEM VERKAUF ENTSTEHEN KÖNNEN.

GARANTIE LIMITÉE

EIZO NANA O CORPORATION (ci-après dénommé « **EIZO** ») et les distributeurs autorisés par EIZO (ci-après dénommés « **Distributeurs** »), sous réserve et conformément aux termes de cette garantie limitée (ci-après dénommée « **Garantie** »), garantissent à l'acheteur initial (ci-après dénommé « **Acheteur initial** ») du produit spécifié dans la présente (ci-après dénommé « **Produit** ») acheté auprès d'EIZO ou de Distributeurs agréés EIZO, que EIZO et ses Distributeurs auront pour option de réparer ou remplacer gratuitement le Produit si l'Acheteur initial constate, pendant la Période de garantie (définie ci-dessous), qu'il y a un dysfonctionnement ou que le Produit a subi un dommage dans le cadre d'une utilisation normale du Produit conformément à la description du mode d'emploi qui accompagne le Produit (ci-après dénommé « **Manuel d'utilisation** »).

La période de cette Garantie est limitée à (i) cinq (5) ans à partir de la date d'achat du Produit ou à (ii) 30 000 heures d'utilisation du Produit (ci-après dénommée « **Période de Garantie** »), sous réserve, toutefois, que la Période de Garantie du panneau LCD du Produit est limitée à trois (3) ans à partir de la date d'achat du Produit. EIZO et ses Distributeurs déclinent toute responsabilité ou obligation concernant ce Produit face à l'Acheteur initial ou à toute autre personne à l'exception de celles stipulées dans la présente Garantie.

EIZO et ses Distributeurs cesseront de tenir ou conserver en stock toute pièce de ce Produit après l'expiration de la période de sept (7) ans suivant l'arrêt de la production de telles pièces. Pour réparer le moniteur, EIZO et ses distributeurs utiliseront des pièces de rechange conformes à nos normes de contrôle qualité.

La Garantie est valable uniquement dans les pays ou les territoires où se trouvent les Distributeurs. La Garantie ne limite aucun des droits reconnus par la loi à l'Acheteur initial.

Nonobstant toute autre clause de cette Garantie, EIZO et ses Distributeurs n'auront d'obligation dans le cadre de cette Garantie pour aucun des cas énumérés ci-dessous :

- (a) Tout défaut du Produit résultant de dommages occasionnés lors du transport, d'une modification, d'une altération, d'un abus, d'une mauvaise utilisation, d'un accident, d'une installation incorrecte, d'un désastre, d'un entretien et/ou d'une réparation incorrects effectués par une personne autre que EIZO ou ses Distributeurs ;
- (b) Toute incompatibilité du Produit résultant d'améliorations techniques et/ou réglementations possibles ;
- (c) Toute détérioration du capteur ;
- (d) Toute détérioration des performances d'affichage causée par la détérioration des éléments consommables tels que le panneau LCD et/ou le rétroéclairage, etc. (par exemple des changements de luminosité, des changements de l'uniformité de la luminosité, des modifications de couleur, des changements de l'uniformité des couleurs, des défauts de pixels y compris des pixels brûlés, etc.);
- (e) Tout défaut du Produit causé par un appareil externe ;
- (f) Tout défaut d'un Produit sur lequel le numéro de série original a été altéré ou supprimé ;
- (g) Tout défaut du Produit causé par un écoulement du liquide contenu dans les piles ;
- (h) Toute détérioration normale du Produit, particulièrement celle des consommables, des accessoires et/ou des pièces reliées au Produit (piles, touches, éléments pivotants, télécommande, câbles, Manuel d'utilisation etc.), et
- (i) Toute déformation, décoloration, et/ou gondolage de l'extérieur du Produit, y compris celle de la surface du panneau LCD.

Pour bénéficier d'un service dans le cadre de cette Garantie, l'Acheteur initial doit renvoyer le Produit port payé, dans son emballage d'origine ou tout autre emballage approprié offrant un degré de protection équivalent, au Distributeur local, et assumera la responsabilité des dommages et/ou perte possibles lors du transport. L'Acheteur initial doit présenter une preuve d'achat du Produit comprenant sa date d'achat pour bénéficier de ce service dans le cadre de la Garantie.

La Période de garantie pour tout Produit remplacé et/ou réparé dans le cadre de cette Garantie expirera à la fin de la Période de garantie initiale.

EIZO OU SES DISTRIBUTEURS NE SAURAIENT ÊTRE TENUS RESPONSABLES DES DOMMAGES OU PERTES DE DONNÉES OU D'AUTRES INFORMATIONS STOCKÉES DANS UN MÉDIA QUELCONQUE OU UNE AUTRE PARTIE DU PRODUIT RENVOYÉ À EIZO OU AUX DISTRIBUTEURS POUR RÉPARATION.

AUCUNE AUTRE GARANTIE, EXPLICITE OU TACITE, N'EST OFFERTE PAR EIZO ET SES DISTRIBUTEURS CONCERNANT LE PRODUIT ET SES QUALITÉS, PERFORMANCES, QUALITÉ MARCHANDE OU ADAPTATION À UN USAGE PARTICULIER. EN AUCUN CAS, EIZO OU SES DISTRIBUTEURS NE SERONT RESPONSABLES DES DOMMAGES FORTUITS, INDIRECTS, SPÉCIAUX, INDUITS, OU DE TOUT AUTRE DOMMAGE QUEL QU'IL SOIT (Y COMPRIS, SANS LIMITATION, LES DOMMAGES RÉSULTANT D'UNE PERTE DE PROFIT, D'UNE INTERRUPTION D'ACTIVITÉS, D'UNE PERTE DE DONNÉES COMMERCIALES, OU DE TOUT AUTRE MANQUE À GAGNER) RÉSULTANT DE L'UTILISATION OU DE L'INCAPACITÉ D'UTILISER LE PRODUIT OU AYANT UN RAPPORT QUELCONQUE AVEC LE PRODUIT, QUE CE SOIT SUR LA BASE D'UN CONTRAT, D'UN TORT, D'UNE NÉGLIGENCE, D'UNE RESPONSABILITÉ STRICTE OU AUTRE, MÊME SI EIZO OU SES DISTRIBUTEURS ONT ÉTÉ AVERTIS DE LA POSSIBILITÉ DE TELS DOMMAGES. CETTE LIMITATION INCLUT AUSSI TOUTE RESPONSABILITÉ QUI POURRAIT ÊTRE SOULEVÉE LORS DES RÉCLAMATIONS D'UN TIERS CONTRE L'ACHETEUR INITIAL. L'ESSENCE DE CETTE CLAUSE EST DE LIMITER LA RESPONSABILITÉ POTENTIELLE DE EIZO ET DE SES DISTRIBUTEURS RÉSULTANT DE CETTE GARANTIE LIMITÉE ET/OU DES VENTES.

GARANTÍA LIMITADA

EIZO NANO CORPORATION (en lo sucesivo “EIZO”) y sus distribuidores autorizados (en lo sucesivo los “Distribuidores”), con arreglo y de conformidad con los términos de esta garantía limitada (en lo sucesivo la “Garantía”), garantizan al comprador original (en lo sucesivo el “Comprador original”) que compró el producto especificado en este documento (en lo sucesivo el “Producto”) a EIZO o a sus Distribuidores, que EIZO y sus Distribuidores, a su propio criterio, repararán o sustituirán el Producto de forma gratuita si el Comprador original detecta dentro del periodo de la Garantía (indicado posteriormente) que el Producto no funciona correctamente o que se ha averiado durante el uso normal del mismo de acuerdo con las indicaciones del manual de instrucciones suministrado con el Producto (en lo sucesivo el “Manual del usuario”).

El periodo de validez de esta Garantía está limitado a (i) cinco (5) años a partir de la fecha de compra del Producto o (ii) a 30.000 horas de uso del Producto (en adelante designado como el “Periodo de Garantía”); con la exclusión, no obstante, de que el período de garantía del panel LCD del Producto está limitado a tres (3) años a partir de la fecha de compra del Producto. EIZO y sus Distribuidores no tendrán ninguna responsabilidad ni obligación con respecto al Producto para con el Comprador original ni con terceros que no sean las estipuladas en la presente Garantía.

EIZO y sus Distribuidores no estarán obligados a suministrar cualquier recambio del Producto una vez pasados siete (7) años desde que se deje de fabricar el mismo. Para la reparación del monitor, EIZO y los distribuidores utilizarán repuestos que cumplan con nuestros estándares de control de calidad.

La Garantía es válida sólo en los países y territorios donde están ubicados los Distribuidores. La Garantía no restringe ningún derecho legal del Comprador original.

A pesar de las estipulaciones de esta Garantía, EIZO y sus Distribuidores no tendrán obligación alguna bajo esta Garantía en ninguno de los casos expuestos a continuación:

- (a) Cualquier defecto del Producto causado por daños en el transporte, modificación, alteración, abuso, uso incorrecto, accidente, instalación incorrecta, desastre, mantenimiento incorrecto y/o reparación indebida realizada por un tercero que no sea EIZO o sus Distribuidores.
- (b) Cualquier incompatibilidad del Producto debida a posibles innovaciones técnicas y/o reglamentaciones.
- (c) Cualquier deterioro del sensor.
- (d) Cualquier deterioro en el rendimiento de la visualización causado por fallos en las piezas consumibles como el panel LCD y/o la "Backlight", etc. (p. ej. cambios de brillo, cambios de uniformidad del brillo, cambios de color, cambios de uniformidad del color, defectos de píxeles, incluyendo píxeles muertos, etc.).
- (e) Cualquier defecto del Producto causado por un equipo externo.
- (f) Cualquier defecto del Producto en el que haya sido alterado o borrado el número de serie original.
- (g) Cualquier defecto del Producto casusado por fugas de líquido de las pilas.
- (h) Cualquier deterioro normal del Producto, y en particular de las piezas consumibles, accesorios y demás (p. ej. pilas, botones, piezas giratorias, mando a distancia, cables, Manual del usuario, etc.).
- (i) Cualquier deformación, decoloración y/o alabeo del exterior del Producto incluida la superficie del panel LCD.

Para obtener servicio en los términos de esta Garantía, el Producto deberá ser enviado por el Comprador original, a su Distribuidor local, con el transporte previamente pagado, en el embalaje original u otro embalaje adecuado que ofrezca el mismo grado de protección, asumiendo el riesgo de daños y/o pérdida del Producto durante el transporte. El Comprador original deberá presentar un comprobante de compra del Producto en el que se refleje la fecha de compra del mismo cuando lo solicite el servicio de Garantía.

El Periodo de garantía para cualquier Producto reemplazado y/o reparado en los términos de esta Garantía expirará al vencer el Periodo de garantía original.

EIZO O LOS DISTRIBUIDORES AUTORIZADOS DE EIZO NO SE RESPONSABILIZAN DE NINGÚN DAÑO O PÉRDIDA QUE PUEDAN SUFRIR LOS DATOS U OTRA INFORMACIÓN ALMACENADA EN CUALQUIER MEDIO O CUALQUIER PARTE DE CUALQUIER PRODUCTO DEVUELTO A EIZO O A LOS DISTRIBUIDORES DE EIZO PARA SU REPARACIÓN.

EIZO Y LOS DISTRIBUIDORES AUTORIZADOS DE EIZO NO OFRECEN NINGUNA OTRA GARANTÍA, IMPLÍCITA NI EXPLÍCITA, CON RESPECTO AL PRODUCTO Y A SU CALIDAD, RENDIMIENTO, COMERCIABILIDAD E IDONEIDAD PARA CUALQUIER USO EN PARTICULAR. EN NINGÚN CASO SERÁN EIZO O LOS DISTRIBUIDORES AUTORIZADOS DE EIZO RESPONSABLES DE NINGÚN DAÑO EMERGENTE, INDIRECTO, ESPECIAL, INHERENTE O CUALQUIERA QUE SEA (INCLUYENDO, SIN LIMITACIÓN, DAÑOS POR LUCRO CESANTE, INTERRUPCIÓN DE LA ACTIVIDAD COMERCIAL, PÉRDIDA DE INFORMACIÓN COMERCIAL O CUALQUIER OTRA PÉRDIDA PECUNIARIA) QUE SE DERIVE DEL USO O IMPOSIBILIDAD DE USO DEL PRODUCTO O EN RELACIÓN CON EL PRODUCTO, YA SEA BASADO EN CONTRATO, POR AGRAVIO, NEGLIGENCIA, ESTRICTA RESPONSABILIDAD O CUALQUIERA QUE SEA, AUN CUANDO SE HAYA ADVERTIDO A EIZO O A LOS DISTRIBUIDORES DE EIZO DE LA POSIBILIDAD DE TALES DAÑOS. ESTA EXCLUSIÓN TAMBIÉN ABARCA CUALQUIER RESPONSABILIDAD QUE PUEDA DERIVARSE DE RECLAMACIONES HECHAS POR UN TERCERO CONTRA EL COMPRADOR ORIGINAL. LA ESENCIA DE ESTA ESTIPULACIÓN ES LIMITAR LA RESPONSABILIDAD POTENCIAL DE EIZO Y LOS DISTRIBUIDORES QUE PUDIERA DERIVARSE DE ESTA GARANTÍA LIMITADA Y/O VENTAS.

GARANZIA LIMITATA

EIZO NANO CORPORATION (a cui si farà riferimento da qui in poi con “EIZO”) ed i Distributori autorizzati da EIZO (a cui si farà riferimento da qui in poi con “Distributori”) garantiscono, secondo i termini di questa garanzia limitata (a cui si farà riferimento da qui in poi con “Garanzia”) all’acquirente originale (a cui si farà riferimento da qui in poi con “Acquirente originale”) che ha acquistato il prodotto specificato in questo documento (a cui si farà riferimento da qui in poi con “Prodotto”) da EIZO o dai suoi Distributori, che EIZO e i distributori, a loro discrezione, ripareranno o sostituiranno il Prodotto senza addebito se l’Acquirente originale trova, entro il periodo della Garanzia (definito sotto), che il Prodotto malfunziona e si è danneggiato nel corso del suo normale utilizzo osservando le indicazioni del manuale di istruzioni allegato al Prodotto (a cui si farà riferimento da qui in poi con “Manuale utente”).

La presente Garanzia è limitato a (i) cinque (5) anni a partire dalla data d’acquisto del Prodotto; o, limitato (ii) allo scadere di 30.000 ore d’utilizzo del Prodotto (a cui si farà riferimento da qui in poi con “Periodo di Garanzia”); tenendo però presente che il Periodo di garanzia del pannello LCD del Prodotto è limitato a tre (3) anni dalla data d’acquisto del Prodotto. EIZO e i suoi Distributori non si assumono alcuna responsabilità e non hanno alcun obbligo riguardo al Prodotto verso l’Acquirente originale o terzi diversi da quelli relativi a questa Garanzia.

EIZO e i suoi Distributori cesseranno di tenere o di conservare qualsiasi ricambio del Prodotto allo scadere di sette (7) anni dopo che la produzione di tali ricambi è stata terminata. Per la riparazione del monitor, EIZO e i Distributori utilizzeranno parti di ricambio conformi ai nostri standard di controllo della qualità.

La Garanzia è valida soltanto nei paesi dove ci sono i Distributori EIZO. La Garanzia non limita alcun diritto legale dell’Acquirente originale.

Indipendentemente da qualsiasi altra condizione di questa Garanzia, EIZO e i suoi Distributori non avranno alcun obbligo derivante da questa Garanzia in ognuno dei casi elencati di seguito:

- (a) Qualsiasi difetto del Prodotto causato da danni di trasporto, modifiche, alterazioni, abusi, usi impropri, incidenti, installazione errata, calamità, manutenzione errata e/o riparazioni improprie eseguite da terze parti che non siano EIZO o i suoi Distributori.
- (b) Qualsiasi incompatibilità del Prodotto dovuta a possibili innovazioni tecniche e/o normative.
- (c) Qualsiasi deterioramento del sensore.
- (d) Qualsiasi deterioramento delle prestazioni dello schermo causato dal deterioramento delle parti consumabili, come il pannello LCD e/o la retroilluminazione, ecc. (per esempio: i cambiamenti di luminosità, cambiamenti di uniformità della luminosità, i cambiamenti di colore, i cambiamenti di uniformità del colore, i difetti dei pixel, inclusi i pixel bruciati, ecc.).
- (e) Qualsiasi difetto del Prodotto causato da apparecchiature esterne.
- (f) Qualsiasi difetto del Prodotto in cui il numero di serie originale sia stato alterato o rimosso.
- (g) Qualsiasi difetto del Prodotto causato dalla fuoriuscita di liquido dalle pile.
- (h) Qualsiasi normale deterioramento del Prodotto, in particolar modo nelle sue parti di consumo, accessori, e/o attacchi (per esempio: pile, tasti, parti rotanti, telecomando, cavi, Manuale dell’utente, ecc.).
- (i) Qualsiasi tipo di deformazione, scolorimento, e/o di involucro esterno del Prodotto inclusa la superficie del pannello LCD.

Per ricevere assistenza tecnica con questa Garanzia, l’Acquirente originale deve inviare il Prodotto, con trasporto pre-pagato, nella sua confezione originale o altra confezione adeguata che fornisce un livello analogo di protezione, assumendosi il rischio di danni e/o perdita in transito, al Distributore locale. L’Acquirente originale deve presentare la prova di acquisto che stabilisce la data di acquisto del Prodotto quando richiede servizio sotto Garanzia.

Il Periodo di garanzia per qualsiasi Prodotto sostituito e/o riparato sotto questa Garanzia scade alla fine del Periodo di garanzia originale.

EIZO O I SUOI DISTRIBUTORI NON SONO RESPONSABILI PER QUALSIASI DANNO O PERDITA DI DATI O ALTRE INFORMAZIONI MEMORIZZATI SU QUALSIASI SUPPORTO O QUALSIASI PARTE DI QUALSIASI PRODOTTO INVIATO A EIZO O I SUOI DISTRIBUTORI PER RIPARAZIONI.

EIZO E I SUOI DISTRIBUTORI NON OFFRONO ALCUNA GARANZIA ADDIZIONALE, IMPLICITA O ESPLICITA, RIGUARDO IL PRODOTTO E LA SUA QUALITÀ, PRESTAZIONI, VENDIBILITÀ O APPROPRIATEZZA PER QUALSIASI USO PARTICOLARE. IN NESSUN CASO EIZO O I DISTRIBUTORI EIZO AUTORIZZATI SARANNO RESPONSABILI PER QUALSIASI DANNO ACCIDENTALE, INDIRECTO, SPECIALE, CONSEGUENTE O DI QUALSIASI ALTRA NATURA (INCLUSI, SENZA LIMITI, DANNI PER PERDITA DI PROFITTI, INTERRUZIONE DELLE ATTIVITÀ, PERDITA DI INFORMAZIONI D’AFFARI O QUALSIASI ALTRA PERDITA PECUNIARIA) DERIVANTI DALL’USO O DALL’IMPOSSIBILITÀ DI USARE IL PRODOTTO O IN QUALSIASI RELAZIONE AL PRODOTTO, SIA SU BASE DI CONTRATTO, TORTO, NEGLIGENZA, STRETTA RESPONSABILITÀ O ALTRIMENTI, ANCHE SE EIZO O I DISTRIBUTORI EIZO AUTORIZZATI SONO STATI AVVERTITI DELLA POSSIBILITÀ DI TALI DANNI. QUESTA ESCLUSIONE INCLUDE ANCHE QUALSIASI RESPONSABILITÀ CHE POSSA INSORGERE DA RECLAMI DI TERZI CONTRO L’ACQUIRENTE ORIGINALE. L’ESSENZA DI QUESTO PROVVEDIMENTO È LIMITARE LA RESPONSABILITÀ POTENZIALE DI EIZO E DEI DISTRIBUTORI DERIVANTE DA QUESTA GARANZIA LIMITATA E/O DALLE VENDITE.

BEGRÄNSAD GARANTI

EIZO NANO CORPORATION (nedan kallat "EIZO") och EIZOs auktoriserade distributörer (nedan kallade "Distributörer") garanterar i enlighet med villkoren i denna begränsade garanti (nedan kallad "Garantin") den ursprunglige köparen (nedan kallad den "Ursprunglige köparen") som köpte den i dokumentet specificerade produkten (nedan kallad "Produkten") från EIZO eller Distributörer, att EIZO eller Distributörer enligt eget gottfinnande kostnadsfritt antingen reparera eller byta ut den defekta Produkten om den Ursprunglige köparen inom Garantiperioden (definieras nedan) upptäcker att Produkten fungerar felaktigt eller skadas under normal användning av Produkten i enlighet med beskrivningen i bruksanvisningen (nedan kallad "Bruksanvisning").

Giltighetsperioden för denna garanti är begränsad till (i) fem (5) år från datumet för Produktens inköp eller, om detta inträffar tidigare, begränsat till utlöpanget av (ii) 30 000 timmars användning av Produkten (häri kallad "Garantiperioden"). Garantiperioden för Produktens LCD-panel är dock begränsad till tre (3) år från datumet för Produktens inköp. EIZO och Distributörer ska inte under några villkor ha något annat ansvar än vad som anges i denna garanti gällande Produkten i relation till den Ursprunglige köparen eller tredje part.

EIZO och Distributörer kommer att upphöra med lagerhållning av Produktens delar efter sju (7) år efter att produktionen av dessa delar upphört. När skärmen repareras använder EIZO och distributörer reservdelar som uppfyller våra kvalitetsstandarder.

Garantin är endast giltig i de länder där det finns Distributörer. Garantin begränsar inte några av den Ursprunglige köparens lagstadgade rättigheter.

Oavsett andra villkor i denna garanti ska inte EIZO Distributörer under några villkor ha något ansvar i något av de fall som beskrivs nedan:

- (a) När någon bristfällighet hos Produkten kan härledas till att ha uppstått vid frakt, modifiering, ändring, felaktigt handhavande, olycka, felaktig installation, katastrof, felaktigt underhåll och/eller felaktig reparation utförd av tredje part annan än EIZO och Distributörer.
- (b) Alla former av inkompatibilitet hos Produkten på grund av möjliga tekniska innovationer och/eller bestämmelser.
- (c) Alla försämringar av sensorn.
- (d) Alla försämringar av bildens prestanda beroende på förbrukningsdelar så som LCD-panel och/eller bakgrundsbelysning etc. (t.ex. ändringar i ljusstyrka, jämnhet i ljusstyrka, färg, färgjämnhet, defekta pixlar och/eller fast lysande pixlar etc.).
- (e) Alla defekter hos Produkten som orsakats av extern utrustning.
- (f) Alla defekter hos Produkten på vilken det ursprungliga serienumret har ändrats eller avlägsnats.
- (g) Alla produktfel som orsakas av vätska som läcker från batteriet.
- (h) All normal försämring av Produkten, speciellt förbrukningsartiklar, tillbehör och/eller yttre delar (t.ex. batterier, knappar, roterande delar, fjärrkontroll, kablar, Bruksanvisningen etc.).
- (i) Varje deformation, missfärgning och/eller skevhet av Produktens yttre inklusive ytan på LCD-panelen.

För att erhålla service under denna garanti måste den Ursprunglige köparen (med hänseende till risken för skada och/eller förlust under transport) leverera Produkten till närmaste Distributör med förebetalad frakt, i dess ursprungliga förpackning eller annan fullgod förpackning som ger likvärdigt skydd. Den Ursprunglige köparen måste kunna visa inköpsbevis för Produkten som klargör Produktens inköpsdatum vid begäran av garantiservice.

Garantiperioden för alla utbytta och/eller reparerade produkter under denna garanti skall upphöra vid utgången av den ursprungliga Garantiperioden.

EIZO ELLER DISTRIBUTÖRER ÄR INTE ANSVARIGA FÖR NÅGON FORM AV SKADA ELLER FÖRLUST AV DATA ELLER ANNAN INFORMATION SOM HAR LAGRATS I NÅGON FORM AV MEDIA ELLER ANNAN DEL AV NÅGON PRODUKT SOM HAR RETURNERATS TILL EIZO ELLER DISTRIBUTÖRER FÖR REPARATION.

EIZO OCH DISTRIBUTÖRERNA GARANTERAR INGET, UTTRYCKLIGEN ELLER UNDERFÖRSTÅTT, VAD BETRÄFFAR PRODUKTEN OCH DESS KVALITET, PRESTANDA, SÄLJBARHET ELLER LÄMPLIGHET FÖR NÅGON FORM AV SPECIELL ANVÄNDNING. UNDER INGA OMSTÄNDIGHETER SKALL EIZO ELLER DISTRIBUTÖRERNA HÅLLAS ANSVARIGA FÖR NÅGRA SOM HELST UNDERORDNADE, INDIREKTA, SPECIELLA, DÄRAV FÖLJANDE ELLER ÖVRIGA SKADOR (INKLUSIVE, UTAN BEGRÄNSNING TILL, SKADOR FÖR FÖRLUST AV INKOMST, AVBRUTEN AFFÄRSRÖRELSE, FÖRLUST AV AFFÄRSINFORMATION ELLER ANNAN SÄRSKILD FÖRLUST) SOM UPPSTÅTT SOM ETT RESULTAT AV ANVÄNDNING ELLER OFÖRMÅGA ATT ANVÄNDA PRODUKTEN ELLER I NÅGON FORM AV ANSLUTNING TILL PRODUKTERNA, VARE SIG DETTA GRUNDAS PÅ KONTRAKT, ÅTALBAR HANDLING, FÖRSUMLIGHET, ANSVARSSKYLDIGHET ELLER ANNAT, ÄVEN OM EIZO ELLER DISTRIBUTÖRERNA HAR INFORMERATS BETRÄFFANDE MÖJLIGHET ATT SÅDANA SKADOR FÖRELIGGER. DETTA UNDANTAG OMFATTAR ÄVEN ALL FORM AV ANSVARSSKYLDIGHET SOM KAN UPPSTÅ GENOM EN TREDJE PARTS ANSPRÅK GENTEMOT DEN URSPRUNGLIGE KÖPAREN. GRUNDBESTÄNDSDELEN I BESTÄMMELEN ÄR ATT BEGRÄNSA DET EVENTUELLA ANSVARSTAGANDET FÖR EIZO OCH DISTRIBUTÖRERNA SOM KAN UPPSTÅ GENOM DENNA BEGRÄNSADE GARANTI OCH/ELLER FÖRSÄLJNING.

ΠΕΡΙΟΡΙΣΜΕΝΗ ΕΓΓΥΗΣΗ

Η ΕΙΖΟ NANAO CORPORATION (στο εξής «**ΕΙΖΟ**») και οι διανομείς που εξουσιοδοτεί η ΕΙΖΟ (στο εξής «**Διανομείς**») παρέχουν εγγύηση, υποκείμενη και σύμφωνα με τους όρους της παρούσας περιορισμένης εγγύησης (στο εξής «**Εγγύηση**»), στον αρχικό αγοραστή (στο εξής «**Αρχικός Αγοραστής**») ο οποίος αγόρασε το προϊόν που καθορίζεται στο παρόν έγγραφο (στο εξής «**Προϊόν**») από την ΕΙΖΟ ή τους Διανομείς, η οποία εξασφαλίζει ότι η ΕΙΖΟ και οι Διανομείς, σύμφωνα με τη διακριτή ευχέρειά τους, είτε θα επισκευάσουν είτε θα αντικαταστήσουν το Προϊόν χωρίς χρέωση εάν ο Αρχικός Αγοραστής αντιληφθεί εντός της Περιόδου Εγγύησης (ορίζεται κατωτέρω) ότι το Προϊόν δυσλειτουργεί ή έχει υποστεί βλάβη κατά τη διάρκεια κανονικής χρήσης του Προϊόντος σύμφωνα με την περιγραφή στο εγχειρίδιο χρήσης που συνοδεύει το Προϊόν (στο εξής «**Εγχειρίδιο Χρήστη**»).

Η περίοδος της παρούσας Εγγύησης είναι (i) πέντε (5) έτη από την ημερομηνία αγοράς του Προϊόντος, ή, στη λήξη των (ii) 30.000 ωρών χρήσης του Προϊόντος (στο εξής «**Περίοδος Εγγύησης**»), με την προϋπόθεση, ωστόσο, ότι η Περίοδος Εγγύησης για την οθόνη LCD του Προϊόντος περιορίζεται σε τρία (3) έτη από την ημερομηνία αγοράς του Προϊόντος. Η ΕΙΖΟ και οι Διανομείς δεν φέρουν καμία ευθύνη ή υποχρέωση όσον αφορά το Προϊόν σε σχέση με τον Αρχικό Αγοραστή ή οποιοδήποτε τρίτο μέρος, ούτε άλλη ευθύνη διαφορετική από αυτήν που παρέχεται στην παρούσα Εγγύηση.

Η ΕΙΖΟ και οι Διανομείς θα παύσουν να διατηρούν ή να αποθηκεύουν τυχόν εξαρτήματα του Προϊόντος κατόπιν της λήξης των επτά (7) ετών μετά τη διακοπή της παραγωγής τέτοιων εξαρτημάτων. Κατά την επισκευή της οθόνης, η ΕΙΖΟ και οι Διανομείς θα χρησιμοποιήσουν ανταλλακτικά επισκευής που συμμορφώνονται με τα πρότυπά μας για τη Διασφάλιση Ποιότητας.

Η Εγγύηση ισχύει μόνο σε χώρες ή περιοχές όπου βρίσκονται οι Διανομείς. Η Εγγύηση δεν περιορίζει οποιαδήποτε νόμιμα δικαιώματα του Αρχικού Αγοραστή.

Λαμβανομένης υπόψη κάθε διάταξης της παρούσας Εγγύησης, η ΕΙΖΟ και οι Διανομείς δεν θα έχουν καμία απολύτως υποχρέωση σύμφωνα με την παρούσα Εγγύηση σε οποιαδήποτε από τις περιπτώσεις που διατυπώνονται κατωτέρω:

- (α) Τυχόν ελάττωμα του Προϊόντος που προκαλείται από ζημιά κατά τη μεταφορά, τροποποίηση, αλλαγή, κατάχρηση, λανθασμένη χρήση, ατύχημα, λανθασμένη εγκατάσταση, καταστροφή, εσφαλμένη συντήρηση ή/και λανθασμένη επισκευή από τρίτο μέρος εκτός της ΕΙΖΟ και των Διανομέων,
- (β) Τυχόν ασυμβατότητα του Προϊόντος λόγω πιθανών τεχνικών καινοτομιών ή/και κανονισμών,
- (γ) Τυχόν επιδείνωση του αισθητήρα,
- (δ) Τυχόν επιδείνωση της απόδοσης οθόνης που προκαλείται από τη φθορά αναλώσιμων εξαρτημάτων όπως της οθόνης LCD ή/και του φωτός υποβάθρου, κτλ. (π.χ. αλλαγές στη φωτεινότητα, αλλαγές στην ομοιομορφία φωτεινότητας, αλλαγές στο χρώμα, αλλαγές στην ομοιομορφία χρώματος, ελαττώματα σε pixel περιλαμβανομένων των καμένων pixel, κτλ.),
- (ε) Τυχόν ελάττωμα του Προϊόντος που προκαλείται από εξωτερικό εξοπλισμό,
- (στ) Τυχόν ελάττωμα του Προϊόντος στο οποίο έχει τροποποιηθεί ή αφαιρεθεί ο γνήσιος αριθμός σειράς,
- (ζ) Τυχόν ελάττωμα του Προϊόντος που προκαλείται από διαρροή υγρού από την μπαταρία,
- (η) Τυχόν φυσιολογική φθορά του προϊόντος, ιδιαίτερα αυτής των αναλώσιμων, των αξεσουάρ ή/και των προσαρτημάτων (π.χ. μπαταρίες, κουμπιά, περιστρεφόμενα μέρη, τηλεχειριστήριο, καλώδια, Εγχειρίδιο Χρήστη, κτλ.), και
- (θ) Τυχόν παραμόρφωση, αποχρωματισμό ή/και διαστρέβλωση του εξωτερικού μέρους του προϊόντος, περιλαμβανομένης της επιφάνειας της οθόνης LCD.

Ο Αρχικός Αγοραστής για να δικαιούται υπηρεσίες επισκευής σύμφωνα με την Εγγύηση, θα πρέπει να παραδώσει το Προϊόν, με πληρωμένα τα μεταφορικά έξοδα, στην αρχική του συσκευασία ή σε άλλη επαρκή συσκευασία με ισότιμο βαθμό προστασίας, αναλαμβάνοντας τον κίνδυνο βλάβης ή/και απώλειας κατά τη μεταφορά, στον τοπικό Διανομέα. Ο Αρχικός Αγοραστής όταν ζητά υπηρεσίες επισκευής σύμφωνα με την Εγγύηση, θα πρέπει να προσκομίζει την απόδειξη αγοράς του Προϊόντος και την ημερομηνία της αγοράς.

Η Περίοδος Εγγύησης για οποιοδήποτε αντικατεστημένο ή/και επισκευασμένο προϊόν σύμφωνα με την παρούσα Εγγύηση λήγει στο τέλος της αρχικής Περιόδου Εγγύησης.

Η ΕΙΖΟ Ή ΟΙ ΔΙΑΝΟΜΕΙΣ ΔΕΝ ΕΥΘΥΝΟΝΤΑΙ ΓΙΑ ΟΠΟΙΟΔΗΠΟΤΕ ΒΛΑΒΗ Ή ΑΠΩΛΕΙΑ ΔΕΔΟΜΕΝΩΝ Ή ΑΛΛΩΝ ΠΛΗΡΟΦΟΡΙΩΝ ΠΟΥ ΑΠΟΘΗΚΕΥΟΝΤΑΙ ΣΕ ΟΠΟΙΟΔΗΠΟΤΕ ΜΕΣΟ Ή ΟΠΟΙΟΔΗΠΟΤΕ ΑΛΛΟ ΜΕΡΟΣ ΣΕ ΟΠΟΙΟΔΗΠΟΤΕ ΠΡΟΪΟΝ ΠΟΥ ΕΠΙΣΤΡΕΦΕΤΑΙ ΣΤΗΝ ΕΙΖΟ Ή ΣΕ ΔΙΑΝΟΜΕΑ ΓΙΑ ΕΠΙΣΚΕΥΗ.

Η ΕΙΖΟ ΚΑΙ ΟΙ ΔΙΑΝΟΜΕΙΣ ΔΕΝ ΠΑΡΕΧΟΥΝ ΚΑΜΙΑ ΠΕΡΑΙΤΕΡΩ ΕΓΓΥΗΣΗ, ΡΗΤΗ Ή ΣΥΝΕΠΑΓΟΜΕΝΗ, ΟΣΟΝ ΑΦΟΡΑ ΤΟ ΠΡΟΪΟΝ ΚΑΙ ΤΗΝ ΠΟΙΟΤΗΤΑ, ΤΗΝ ΑΠΟΔΟΣΗ, ΤΗΝ ΕΜΠΟΡΕΥΣΙΜΟΤΗΤΑ Ή ΤΗΝ ΚΑΤΑΛΛΗΛΟΤΗΤΑ ΤΟΥ ΓΙΑ ΟΠΟΙΟΔΗΠΟΤΕ ΣΥΓΚΕΚΡΙΜΕΝΗ ΧΡΗΣΗ. ΣΕ ΚΑΜΙΑ ΠΕΡΙΠΤΩΣΗ Η ΕΙΖΟ Ή ΟΙ ΔΙΑΝΟΜΕΙΣ ΔΕΝ ΘΑ ΕΥΘΥΝΟΝΤΑΙ ΓΙΑ ΚΑΜΙΑ ΑΠΟΛΥΤΩΣ ΤΥΧΑΙΑ, ΕΜΜΕΣΗ, ΕΙΔΙΚΗ, ΣΥΝΕΠΑΓΟΜΕΝΗ Ή ΑΛΛΗ ΒΛΑΒΗ (ΠΕΡΙΛΑΜΒΑΝΟΜΕΝΩΝ, ΜΕΤΑΞΥ ΑΛΛΩΝ, ΒΛΑΒΩΝ Ή ΑΠΩΛΕΙΑΣ ΚΕΡΔΩΝ, ΔΙΑΚΟΠΗΣ ΕΠΙΧΕΙΡΗΜΑΤΙΚΩΝ ΠΡΑΣΤΗΡΙΟΤΗΤΩΝ, ΑΠΩΛΕΙΑΣ ΕΠΙΧΕΙΡΗΜΑΤΙΚΩΝ ΠΛΗΡΟΦΟΡΙΩΝ Ή ΤΥΧΟΝ ΑΛΛΗΣ ΧΡΗΜΑΤΙΚΗΣ ΑΠΩΛΕΙΑΣ) ΠΟΥ ΠΡΟΚΥΠΤΕΙ ΑΠΟ ΤΗ ΧΡΗΣΗ Ή ΤΗΝ ΑΝΙΚΑΝΟΤΗΤΑ ΧΡΗΣΗΣ ΤΟΥ ΠΡΟΪΟΝΤΟΣ Ή ΤΥΧΟΝ ΑΛΛΗΣ ΣΥΝΔΕΣΗΣ ΜΕ ΤΟ ΠΡΟΪΟΝ, ΕΙΤΕ ΒΑΣΙΖΕΤΑΙ ΣΕ ΣΥΜΒΟΛΑΙΟ, ΒΛΑΒΗ, ΑΜΕΛΕΙΑ, ΑΥΣΤΗΡΗ ΕΥΘΥΝΗ Ή ΕΙΔΑΛΛΩΣ, ΑΚΟΜΗ ΚΙ ΕΑΝ Η ΕΙΖΟ Ή ΟΙ ΔΙΑΝΟΜΕΙΣ ΕΝΗΜΕΡΩΘΟΥΝ ΓΙΑ ΤΗΝ ΠΙΘΑΝΟΤΗΤΑ ΤΕΤΟΙΩΝ ΖΗΜΙΩΝ. Η ΕΞΑΙΡΕΣΗ ΑΥΤΗ ΠΕΡΙΛΑΜΒΑΝΕΙ ΕΠΙΣΗΣ ΟΠΟΙΟΔΗΠΟΤΕ ΕΥΘΥΝΗ ΕΝΔΕΧΕΤΑΙ ΝΑ ΠΡΟΚΥΨΕΙ ΑΠΟ ΑΞΙΩΣΕΙΣ ΤΡΙΤΟΥ ΜΕΡΟΥΣ ΚΑΤΑ ΤΟΥ ΑΡΧΙΚΟΥ ΑΓΟΡΑΣΤΗ. Η ΟΥΣΙΑ ΤΟΥ ΟΡΟΥ ΑΥΤΟΥ ΕΙΝΑΙ ΝΑ ΠΕΡΙΟΡΙΣΕΙ ΤΗΝ ΠΙΘΑΝΗ ΕΥΘΥΝΗ ΤΗΣ ΕΙΖΟ ΚΑΙ ΤΩΝ ΔΙΑΝΟΜΕΩΝ ΠΟΥ ΠΡΟΚΥΠΤΕΙ ΑΠΟ ΤΗΝ ΠΑΡΟΥΣΑ ΕΓΓΥΗΣΗ Ή/ΚΑΙ ΤΙΣ ΠΩΛΗΣΕΙΣ.

ОГРАНИЧЕННАЯ ГАРАНТИЯ

EIZO NANA CORPORATION (называемая в дальнейшем “EIZO”) и авторизованные EIZO дистрибуторы (называемые в дальнейшем “Дистрибуторы”) гарантируют, в соответствии с условиями и пунктами этой ограниченной гарантии (называемой в дальнейшем “Гарантия”), первичному покупателю (называемому в дальнейшем “Первоначальный покупатель”), который приобрел у EIZO или Дистрибуторов продукт, указанный в этом документе (называемый в дальнейшем “Продукт”), что EIZO или Дистрибуторы на свое усмотрение либо бесплатно отремонтируют, либо бесплатно заменят Продукт, если Первоначальный покупатель признает в пределах Гарантийного срока (определенного ниже), что Продукт неисправен или он поврежден процессе нормального использования продукта в соответствии с описанием в инструкции по эксплуатации, прилагаемой к Продукту (называемой в дальнейшем “Руководство пользователя”).

Гарантийный период ограничен сроком (i) пять (5) лет от даты приобретения Продукта, или ограничен сроком (ii) 30 000 часов использования Продукта (называемый в дальнейшем “Гарантийный период”), при условии, что Гарантийный период для панели ЖКД ограничен сроком три (3) года от даты приобретения Продукта. EIZO и Дистрибуторы не несут никакой ответственности и не берут обязательств относительно Продукта по отношению к Первоначальному покупателю или по отношению к любым третьим сторонам, кроме обязательств, оговоренных в этой Гарантии.

EIZO и Дистрибуторы прекратят хранение или складирование любых деталей Продукта по истечении семи (7) лет после прекращения производства таких деталей. В случае ремонта монитора EIZO и Дистрибуторы будут использовать запчасти, которые соответствуют нашим стандартам QC (контроль качества).

Гарантия действительна только в странах или регионах, где расположены Дистрибуторы. Гарантия не ограничивает никакие законные права Первоначального покупателя.

Несмотря на другие условия этой Гарантии EIZO и Дистрибуторы не несут никаких обязательств согласно этой Гарантии в любом из перечисленных ниже случаев:

- (а) Любые дефекты Продукта, вызванные повреждениями при перевозке, модификацией, изменением, неправильным обращением, неправильным использованием, авариями, неправильной установкой, стихийными бедствиями, неправильным уходом и/или неправильным ремонтом третьей стороной, отличной от EIZO или Дистрибуторов;
- (б) Любые несовместимости Продукта из-за технических усовершенствований и/или изменения технических норм;
- (в) Любое повреждение датчика;
- (г) Любые ухудшения работы дисплея, вызванные изнашиванием невосстановимых частей, таких как панель ЖКД и/или подсветка и т.д. (например, изменение в яркости, изменение в равномерности яркости, изменение в цветности, изменение в равномерности цветности, изменение в пикселях, включая выгоревшие пиксели и т.д.);
- (д) Любые дефекты Продукта, вызванные внешним оборудованием;
- (е) Любые дефекты Продукта, при которых оригинальный серийный номер был изменен или удален;
- (ж) Любые дефекты Продукта, вызванные протеканием батареек;
- (з) Любые естественные ухудшения продукта, в частности, вызванные износом расходных частей, принадлежностей и/или приспособлений (например, батареек, кнопок, вращающихся частей, пульта дистанционного управления, кабелей, Руководства пользователя и т.д.); и
- (и) Любые деформации, изменения цвета и/или коробления внешней поверхности продукта, включая поверхность панели ЖКД.

Чтобы получить техническое обслуживание в рамках Гарантии, Первоначальный покупатель должен доставить Продукт местному Дистрибутору, оплатив перевозку, в его оригинальной упаковке или в другой соответствующей упаковке, обеспечивающей равноценную степень защиты, принимая во внимание риск повреждения и/или утери при транспортировке. При запросе технического обслуживания в рамках Гарантии Первоначальный покупатель должен предоставить свидетельство покупки продукта и даты покупки.

Гарантийный период для любого замененного и/или отремонтированного продукта в рамках Гарантии истекает в конце завершения срока действия оригинального Гарантийного периода.

EIZO ИЛИ ДИСТРИБУТОРЫ НЕ НЕСУТ ОТВЕТСТВЕННОСТИ ЗА ЛЮБЫЕ ПОВРЕЖДЕНИЯ ИЛИ УТЕРЮ ДАННЫХ ИЛИ ДРУГОЙ ИНФОРМАЦИИ, ХРАНЯЩИХСЯ НА КАКИХ-ЛИБО НОСИТЕЛЯХ ИНФОРМАЦИИ ИЛИ НА ЛЮБЫХ ДРУГИХ ЧАСТЯХ ПРОДУКТА, КОТОРЫЙ ВОЗВРАЩЕН EIZO ИЛИ ДИСТРИБУТОРАМ ДЛЯ РЕМОНТА.

EIZO И ДИСТРИБУТОРЫ НЕ ДАЮТ НИКАКОЙ ДАЛЬНЕЙШЕЙ ГАРАНТИИ, ВЫРАЖЕННОЙ ИЛИ ПОДРАЗУМЕВАЕМОЙ, ОТНОСИТЕЛЬНО ПРОДУКТА И ЕГО КАЧЕСТВА, ТЕХНИЧЕСКИХ ХАРАКТЕРИСТИК, ТОВАРНОСТИ ИЛИ СООТВЕТСТВИЯ ДЛЯ КАКОГО-ЛИБО ОПРЕДЕЛЕННОГО ИСПОЛЬЗОВАНИЯ. НИ ПРИ КАКИХ УСЛОВИЯХ EIZO ИЛИ ДИСТРИБУТОРЫ НЕ НЕСУТ ОТВЕТСТВЕННОСТИ ЗА ЛЮБОЙ СЛУЧАЙНЫЙ, КОСВЕННЫЙ, СПЕЦИАЛЬНЫЙ, ПОБОЧНЫЙ ИЛИ ИНОЙ УЩЕРБ (ВКЛЮЧАЯ, БЕЗ ОГРАНИЧЕНИЙ, УЩЕРБ ИЗ-ЗА НЕПОЛУЧЕННОЙ ПРИБЫЛИ, ПРЕРЫВАНИЯ БИЗНЕСА, ПОТЕРИ КОММЕРЧЕСКОЙ ИНФОРМАЦИИ ИЛИ ЛЮБЫЕ ДРУГИЕ ФИНАНСОВЫЕ ПОТЕРИ), ВОЗНИКШИЙ ИЗ-ЗА ИСПОЛЬЗОВАНИЯ ИЛИ НЕВОЗМОЖНОСТИ ИСПОЛЬЗОВАТЬ ПРОДУКТ ИЛИ В ЛЮБОЙ ДРУГОЙ СВЯЗИ С ПРОДУКТОМ, ЛИБО ОСНОВАННЫЙ НА КОНТРАКТНЫХ ОТНОШЕНИЯХ, ГРАЖДАНСКИХ ПРАВОНАРУШЕНИЯХ, НЕБРЕЖНОСТИ, ПРИЧИНИЕНИЯ УЩЕРБА ТРЕТЬЕЙ СТОРОНЕ ИЛИ ЧЕМ-ЛИБО ЕЩЕ, ДАЖЕ ЕСЛИ EIZO ИЛИ ДИСТРИБУТОРЫ БЫЛИ УВЕДОМЛЕНЫ О ВОЗМОЖНОСТИ ТАКОГО УЩЕРБА. ЭТО ИСКЛЮЧЕНИЕ ТАКЖЕ ВКЛЮЧАЕТ ЛЮБЫЕ ОБЯЗАТЕЛЬСТВА, КОТОРЫЕ МОГУТ ВОЗНИКНУТЬ В РЕЗУЛЬТАТЕ ТРЕБОВАНИЙ ТРЕТЬЕЙ СТОРОНЫ В ОТНОШЕНИИ ПЕРВОНАЧАЛЬНОГО ПОКУПАТЕЛЯ. СУЩЕСТВОМ ЭТОГО ПОЛОЖЕНИЯ ЯВЛЯЕТСЯ ОГРАНИЧЕНИЕ ПОТЕНЦИАЛЬНОЙ ОТВЕТСТВЕННОСТИ EIZO И ДИСТРИБУТОРОВ, ВОЗНИКАЮЩЕЙ ИЗ-ЗА ЭТОЙ ОГРАНИЧЕННОЙ ГАРАНТИИ И/ЛИ ПРОДАЖ.

有限责任保证书

EIZO NANA O 有限公司（以下简称“EIZO”）和 EIZO 授权的经销商（以下简称“经销商”），接受并依照本有限责任保证书（以下简称“保证书”）之条款，向从 EIZO 和经销商购买本文中规定产品（以下简称“产品”）的原买方（以下称“原买方”）提供保证：在保证期内（规定如下），如果原买方发现按本产品所附使用说明书（以下简称“用户手册”）所述方式正常使用本产品过程中，本产品出现故障或损坏，EIZO 和经销商根据其独立的判断免费修理或更换该产品。

本保证期限定为 (i) 自本产品购买之日起的五 (5) 年期间或限定为到达 (ii) 使用本产品 3 万小时的期限（以下简称“保证期限”），但本产品的液晶显示屏 (LCD) 的保证期限定为自本产品购买之日起的三 (3) 年期间。EIZO 和经销商将不向原买方或任何第三方承担本保证书所规定之外的与本产品有关任何责任或义务。

本产品的任何部件停产七 (7) 年后，EIZO 和经销商将不再保留或保管任何这类部件。维修显示器时，EIZO 与经销商将使用符合我方质量控制标准的替换零件。

本保证书仅对于设有经销商的国家或地区有效。本保证书并不限定原买方的任何法律权利。

无论本保证书的任何其他条款如何规定，对于任何下列情况之一，EIZO 和经销商将不承担本保证书规定责任：

- (a) 由于运输损害、改装、改动、滥用、误用、意外事故、错误安装、灾害、维护不善和 / 或由除 EIZO 和经销商以外的第三方进行不适当的修理造成本产品的任何故障。
- (b) 由于可能发生的技术变更和 / 或调整造成本产品的任何不兼容性。
- (c) 传感器的任何劣化。
- (d) 由于诸如液晶显示屏 (LCD) 和 / 或背灯等消耗品部件的老化造成的任何显示性能低劣（如亮度变化、亮度均一性变化、色彩变化、色彩均一性变化、如烧伤像素等像素缺陷）。
- (e) 因外部设备造成本产品的任何故障。
- (f) 因本产品的原序号被改变或消除造成本产品的任何故障。
- (g) 因电池液体泄漏造成本产品的任何故障。
- (h) 本产品的任何正常老化，尤其是消耗品、附件和 / 或附加装置（如电池、按钮、旋转部件、遥控器、电缆、用户手册等）、以及
- (i) 本产品表面包括液晶显示屏 (LCD) 表面的任何变形、变色和 / 翘曲。

为了获得本保证书规定的服务，原买方必须使用原包装或其他具有同等保护程度的适当包装将本产品运送到当地的经销商，并且预付运费，承担运输中的损坏和 / 或损失的风险。要求提供本保证书规定的服务时，原买方必须提交购买本产品和标明此购买日期的证明。

按本保证书规定进行了更换和 / 或修理的任何产品的保证期限，将在原保证期限结束时终止。

在返回给 EIZO 和经销商进行修理后，任何产品的任何媒体或任何部件中储存的数据或其他信息发生任何损坏或损失，对此 EIZO 和经销商将不承担责任。

对于本产品及其质量、性能、可销售性以及对于特殊用途的适合性，EIZO 和经销商不提供其他任何明示或暗示的保证。因使用本产品或无法使用本产品或因与本产品有任何关系（无论是否根据合同）而造成：任何附带的、间接的、特殊的、随之发生的或其他的损害（包括但不限于：利润损失、业务中断、业务信息丢失或其他任何金钱损失）以及侵权行为、过失、严格赔偿责任或其他责任，即使已经向 EIZO 和经销商提出了发生这些损害的可能性，对此 EIZO 和经销商概不承担责任。本免责条款还包括因第三方向原买方提出索赔而可能发生的任何责任。本条款的本质是限定由于本有限责任保证书和 / 或销售本产品所发生的 EIZO 和经销商的潜在责任。

China Measures for RoHS Compliance in ChinaRoHS

关于电子信息产品污染控制标识



本标识根据「电子信息产品污染控制管理办法」，适用于在中华人民共和国销售的电子信息产品。标识中央的数字为环保使用期限的年数。只要您遵守该产品相关的安全及使用注意事项，在自制造日起算的年限内，不会产生对环境污染或人体及财产的影响。上述标识粘贴在机器背面。

• 有毒有害物质或元素的名称及含量

部件名称	有毒有害物质或元素					
	铅 (Pb)	汞 (Hg)	镉 (Cd)	六价铬 (Cr (VI))	多溴联苯 (PBB)	多溴二苯醚 (PBDE)
印刷电路板	×	○	○	○	○	○
机箱	○	○	○	○	○	○
液晶显示器	×	○	○	○	○	○
其他	×	○	○	○	○	○

○：表示该有毒有害物质在该部件所有均质材料中的含量均在 SJ/T 11363-2006 规定的限量要求以下。
×：表示该有毒有害物质至少在该部件的某一均质材料中的含量超出 SJ/T 11363-2006 规定的限量要求。
(企业可在此处，根据实际情况对上表中打“×”的技术原因进行进一步说明)

