



# Setup Manual

# DuraVision® DX0211-IP

IP Decoding Box

Software Version 5.5

## Important







Please read this “Setup Manual”, “Installation Manual”, and “Instruction Manual” carefully to familiarize yourself with safe and effective usage.

Please retain this manual for future reference.

- 
- For the latest product information including the “Setup Manual”, refer to our web site :  
[www.eizoglobal.com](http://www.eizoglobal.com)
-

# SAFETY SYMBOLS

This manual and this product use the safety symbols below. They denote critical information. Please read them carefully.

	<b>WARNING</b> Failure to abide by the information in a WARNING may result in serious injury and can be life threatening.		<b>CAUTION</b> Failure to abide by the information in a CAUTION may result in moderate injury and/or property or product damage.
	Indicates a warning or caution. For example,  indicates an “electrical shock” hazard.		
	Indicates a prohibited action. For example,  means “Do not disassemble”.		

## Related Manuals

<b>Setup Manual (this manual)</b>	Describes precautions and procedures for connecting network cameras and for displaying camera images on the monitor. (Installation and initialization guidance)
<b>Installation Manual*<sup>1</sup></b>	Describes network camera registration, function settings, and system settings. (Detail settings guidance)
<b>Instruction Manual*<sup>1</sup></b>	Describes operation of live image screen menus. (Operation guidance)

\*1 The Instruction Manual and Installation Manual for the latest software version used can be obtained from our web site. Select “Manuals” from “Support”, enter “DX0211-IP” in the “Enter model name” box, and click “Search”.

[www.eizo.com](http://www.eizo.com)

Installation of Adobe® Acrobat® Reader® is required.

This product has been adjusted specifically for use in the region to which it was originally shipped. If operated outside this region, the product may not perform as stated in the specifications.

No part of this manual may be reproduced, stored in a retrieval system, or transmitted, in any form or by any means, electronic, mechanical, or otherwise, without the prior written permission of EIZO Corporation.

EIZO Corporation is under no obligation to hold any submitted material or information confidential unless prior arrangements are made pursuant to EIZO Corporation’s receipt of said information. Although every effort has been made to ensure that this manual provides up-to-date information, please note that EIZO product specifications are subject to change without notice.

# PRECAUTIONS

## IMPORTANT

To ensure personal safety and proper maintenance, please read carefully this section and the caution statements on the product.

### Location of the Caution Statements

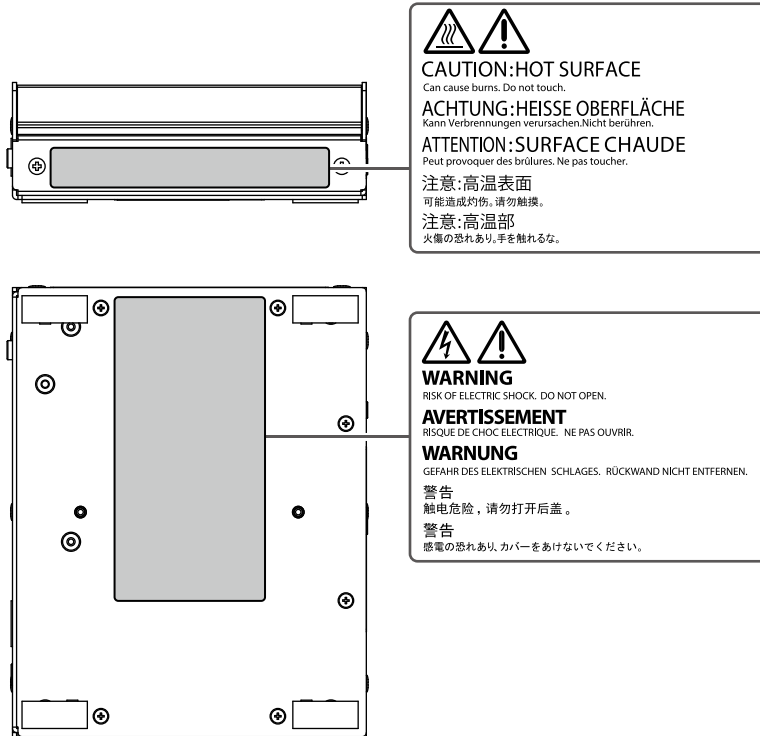

## **WARNING**

---

**If the unit begins to emit smoke, smells like something is burning, or makes strange noises, disconnect all power connections immediately and contact your local EIZO representative for advice.**

Attempting to use a malfunctioning unit may result in fire, electric shock, or equipment damage.

---

### **Do not disassemble or modify the product.**

Touching the internal components may result in electrical shock or burn, as this product contains internal components that may have high voltage or high temperature. Also, modifying the product may result in fire or electrical shock.



### **Refer all servicing to qualified service personnel.**

Do not attempt to service this product yourself as opening or removing covers may result in fire, electric shock, or equipment damage.

---

### **Keep small objects or liquids away from the unit.**

Small objects accidentally falling through the ventilation slots into the cabinet or spillage into the cabinet may result in fire, electric shock, or equipment damage. If an object or liquid falls/ spills into the cabinet, unplug the unit immediately. Have the unit checked by a qualified service engineer before using it again



### **Place the unit at the strong and stable place.**

A unit placed on an inadequate surface may fall and result in injury or equipment damage. If the unit falls, disconnect the power immediately and ask your local EIZO representative for advice. Do not continue using a damaged unit. Using a damaged unit may result in fire or electric shock.

---

### **Use the unit in an appropriate location.**

Not doing so may result in fire, electric shock, or equipment damage.

- Do not place outdoors.
- Do not place in a transportation system (ship, aircraft, train, automobile, etc.) where it may be affected by strong vibration or shock.
- Do not place in a dusty or humid environment.
- Do not place in environments with corrosive gases (such as sulfur dioxide, hydrogen sulfide, nitrogen dioxide, chlorine, ammonia, and ozone).
- Do not place in environments with dust, components that accelerate corrosion in the atmosphere (such as sodium chloride and sulfur), conductive metals, and so on.
- Do not place in a location where water is splashed on the product (bathroom, kitchen, etc.).
- Do not place in a location where the steam comes directly on the product.
- Do not place near heat generating devices or a humidifier.
- Do not place in a location where the product is subject to direct sunlight.
- Do not place in an inflammable gas environment.



**To avoid danger of suffocation, keep the plastic packing bags away from babies and children.**

---

## WARNING

**When using an AC adapter, use the AC adapter (DVAC-01) specified by our company.**

Using other AC adapters may result in fire or electrical shock.

The DVAC-01 is not provided with a power cord. Prepare a power cord that complies with the standards of the country or region where this product is used.

- Europe: Ratings: 250 VAC, 10 A; Cord type: H05VV-F, GTCE-3, 0.75 mm<sup>2</sup>
- USA: Ratings: 125 VAC, 10 A; Cord type: SVT, 3/18AWG (0.75 mm<sup>2</sup>)

**The AC adapter must be connected to a grounded main outlet.**

Failure to do so may result in fire or electric shock.



**Use the correct voltage.**

- The unit is designed for use with a specific voltage only. Connection to another voltage than specified in this User's Manual may cause fire, electric shock, or equipment damage.
- Do not overload your power circuit, as this may result in fire or electric shock.

**Handle the power cord with care.**

- Do not place the cord underneath the unit or other heavy objects.
- Do not pull on or tie the cord.

If the power cord becomes damaged, stop using it. Use of a damaged cord may result in fire or electric shock.



**When disconnecting the power cord, pull the plug.**

Pulling the cord section may damage it (exposure of the core wire, breaking, etc.) and may result in fire or electrical shock.



OK

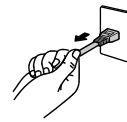

**Never touch the plug and power cord if it begins to thunder.**

Touching them may result in electric shock.



## CAUTION

---

### **Handle with care when carrying the unit.**

Disconnect the power cord and cables when moving the unit. Moving the unit with the cord attached is dangerous. It may result in injury.

---

### **Do not put any object on the product.**

- Do not put any object on or around the product.
- Do not place the product in a poorly-ventilated or narrow place.
- Do not use the product laid down on its side or upside down.

The temperature inside the product may rise and may result in fire, electrical shock, or equipment damage.

---



### **Do not touch the plug or AC adapter with wet hands.**

Doing so may result in electrical shock.

---



### **Use an easily accessible power outlet.**

This will ensure that you can disconnect the power quickly in case of a problem.

---

### **Be careful with the AC adapter because it becomes hot when used.**

- Do not put any objects on the AC adapter or cover the adapter. Also, do not put the AC adapter on carpet or bedding where heat tends to accumulate. Keep the AC adapter away from heat sources such as portable heaters or direct sunlight. Failure to do so may result in fire.
- Do not touch the product with bare hands. Doing so may result in burns.
- When moving the product, be sure to turn off the power switch, unplug the power plug from the outlet, and sufficiently cool down the product before moving.



### **Do not use the AC adapter hung dangling in the air.**

Using the AC adapter hung dangling in the air may result in fire or electrical shock.

---



### **Periodically clean the area around the plug.**

Dust, water, or oil on the plug may result in fire.

---

### **When cleaning the product, shut down the power input.**

Cleaning the unit while it is plugged into a power outlet may result in electric shock.

---

---

# Notice for this product

## About the Usage of This Product

This product is a device that outputs video images from network cameras to a monitor connected using HDMI cable.

When using the product in an application where extremely high reliability and safety are required as mentioned below, take measures to secure safety before using it.

- Transportation equipment (vessels, aircraft, trains, automobiles, etc.)
- Various safety devices such as disaster prevention devices and crime prevention devices
- Equipment and instruments that are directly associated with human life (medical instruments such as life support systems or the equipment used in the operating room)
- Nuclear control devices (nuclear control systems, safety protection systems used at nuclear power facilities, etc.)
- Main communication equipment (operation control systems for transportation systems, air traffic control systems, etc.)

This product may not be covered by warranty for uses other than those described in this manual.

The specifications noted in this manual are only applicable when the following are used:

- Power cords provided with the product
- Signal cables specified by us

Only use optional products manufactured or specified by us with this product.

## About the Installation

When the product is cold and brought into a room or the room temperature goes up quickly, dew condensation may occur on the interior and exterior surfaces of the product. In that case, do not turn the product on. Instead wait until the dew condensation disappears, otherwise it may cause some damage to the product.

Install this product on a stable surface such as a desk with its flat surface as the bottom in a horizontal orientation.

This product can be mounted on the monitor by using a special mounting bracket (separately sold option). The mounting bracket can be purchased from our web site.

[www.eizoglobal.com](http://www.eizoglobal.com)

With respect to the installation orientation when the mounting bracket is used, refer to the instruction sheet of the mounting bracket.

If this product is placed on a lacquer-finished desk, the color may adhere to the bottom of the product due to the composition of the rubber.

## Disclaimer

---

Our company shall bear no responsibility for any damage (including lost profits, etc.) incurred directly or indirectly by using this product or by malfunctions, etc. (including, but not limited to, those caused by the following).

1. Misuse or carelessness by the customer
2. Disassembly, repair, or modification by the customer
3. Inability to display images due to some reason or cause including malfunction or failure of this product
4. Use of the product in combination with a third-party device
5. Occurrence of an event such as infringement of privacy due to some cause with respect to the images monitored by the customer
6. Loss of registered or recorded information due to some cause

While this product displays camera surveillance images, the use of this product alone does not directly prevent crime.

## Network Security Request

---

Because this product is used by connecting to networks, the following risks apply

1. Leakage of information through this product.
2. Unauthorized operation of this product by a malicious third party.
3. Interference or suspension of the use of this product by a malicious third party.

In order to prevent the above described damage, it is the user's responsibility to implement adequate network security measures including the measures described below.

- Use this product with a safety-ensured network by using a firewall or other network security systems.
- Change the administrator password periodically.



# CONTENTS

<b>PRECAUTIONS</b> .....	<b>3</b>	<b>Appendix</b> .....	<b>41</b>
<b>IMPORTANT</b> .....	<b>3</b>	<b>Warning for Radio Interference</b> .....	<b>41</b>
<b>Notice for this product</b> .....	<b>7</b>	<b>LIMITED WARRANTY</b> .....	<b>43</b>
<b>About the Usage of This Product</b> .....	<b>7</b>	<b>Recycling Information / Informationen zum Thema</b>	
<b>About the Installation</b> .....	<b>7</b>	<b>Recycling /</b>	
<b>Disclaimer</b> .....	<b>8</b>	<b>Informations sur le recyclage / Сведения по утилизации</b> .....	<b>i</b>
<b>Network Security Request</b> .....	<b>8</b>		
<b>CONTENTS</b> .....	<b>9</b>		
<b>Package Contents</b> .....	<b>10</b>		
<b>Controls and Functions</b> .....	<b>10</b>		
<b>Setup</b> .....	<b>12</b>		
<b>Connecting the Network Camera(s)</b> .....	<b>13</b>		
<b>Connecting the Monitor</b> .....	<b>14</b>		
<b>Connecting Operating Devices</b> .....	<b>15</b>		
● Connecting a USB device .....	<b>15</b>		
● Connecting an AC Adapter			
(Separately Sold Option) .....	<b>15</b>		
<b>Turning On the Power</b> .....	<b>16</b>		
● Live Image Screen .....	<b>17</b>		
<b>Perform Initialization</b> .....	<b>19</b>		
● Log In .....	<b>19</b>		
● Setting the Date and Time .....	<b>21</b>		
● Performing Network Settings .....	<b>22</b>		
● Registering a Camera Using Auto			
Discovery .....	<b>24</b>		
● Registering a Camera Manually .....	<b>26</b>		
● Setting the Language .....	<b>30</b>		
<b>Reference</b> .....	<b>31</b>		
<b>Confirming the Software Version</b> .....	<b>31</b>		
<b>Specifications</b> .....	<b>32</b>		
● Compatible resolution .....	<b>33</b>		
● Outline Dimensions .....	<b>35</b>		
<b>Troubleshooting</b> .....	<b>36</b>		
<b>The Screen is not Displayed</b> .....	<b>36</b>		
<b>Imaging Problems</b> .....	<b>37</b>		
<b>Setting Problems</b> .....	<b>39</b>		
<b>Other Problems</b> .....	<b>40</b>		

# Package Contents

Check that all of the following parts are included. If any of these are missing or damaged, contact your dealer or local EIZO representative.

- DX0211-IP (this product)
- Setup Manual
- HH050HS  
HDMI cable (HDMI-HDMI)
- Contact Addresses

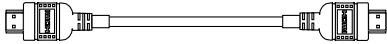

- Mounting screws for PCSK-03 / PCSK-03R  
Used for mounting PCSK-03 or PCSK-03R adapter for smaller device.

## Attention

- No power cord is supplied with this product. Use a power cord that complies with the rating and standards of the country or region where this product is used.

## Note

- It is recommended that the packing box and materials be kept for future usage such as for moving or transporting the product.

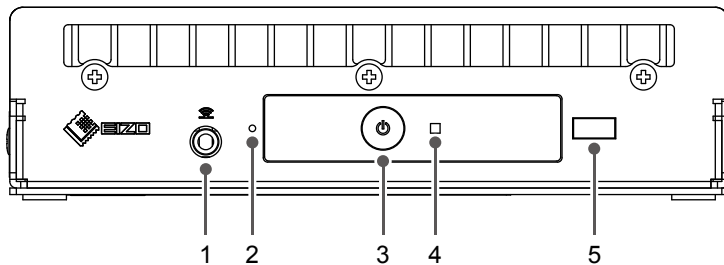

# Controls and Functions

Front

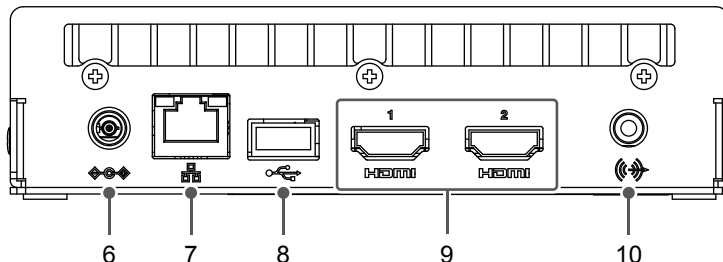

Rear



Names	Details			
<b>1. Connection terminal for the remote control light reception unit</b>	Use this terminal to connect the remote control light reception unit where the remote control light reception section on the main unit cannot be used. (Terminal for use with models with remote controls.)			
<b>2. Reset button</b>	Pressing and holding this button for 10 seconds will initialize the following information: <ul style="list-style-type: none"> <li>• Camera information</li> <li>• USB lock</li> <li>• User account setting</li> </ul>			
<b>3.  button</b>	Turns the power on or off.			
<b>4. Power indicator</b>	Indicates the product's operating status.			
	Blue	Normal operating mode		
	Flashing blue	Starting up		
	Red	Power off		
OFF	Power not connected			
<b>5. Remote control light reception section</b>	Receives signals from the remote control. (A function for use with models equipped with a remote control)			
<b>6. DC input</b>	Connects the AC adapter.			
<b>7. LAN port</b>	Connects the network cable. Inputs power when connected to a network hub that supports PoE+.			
		a) Status LED	Orange	Power is being supplied through the PoE+.
			OFF	Power is being supplied through the AC adapter.
		b) Link LED	Green	Network connection established
OFF			Network connection not established	
<b>8. USB downstream port</b>	Connects a USB mouse, USB keyboard, or joystick.			
<b>9. HDMI1 / HDMI2</b>	HDMI output connector. Connects to monitors that support HDMI.			
<b>10. Stereo mini jack</b>	This terminal emits the beep sound of the product main unit. Connects a commercial stereo mini jack cable. This terminal does not support the audio output of network cameras.			

# Setup

Set up the system until network camera images are displayed on the monitor.  
This product is operated or set using a USB mouse or USB keyboard.

## Setup Flow

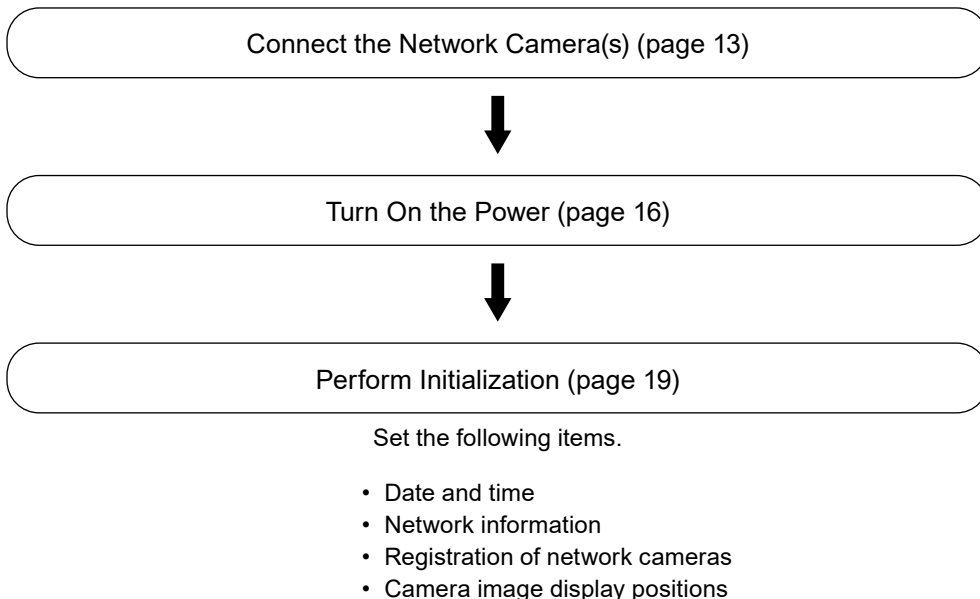

This completes the setup procedure.

---

**Attention**

- The language used in menus and messages displayed when the system of this product is started differs according to the sales region.

---

**Note**

- Initial settings can be made from the Web browser of a computer connected to the same network. For details on setting from a Web browser, refer to the “Installation Manual”.
-

# Connecting the Network Camera(s)

Connect the network cameras to this product according to the following procedure.

## 1. Connect the network camera to this product via the network hub.

1. Connect the network cable (straight cable, Cat 5e or higher) to this product and the LAN port of the network hub.

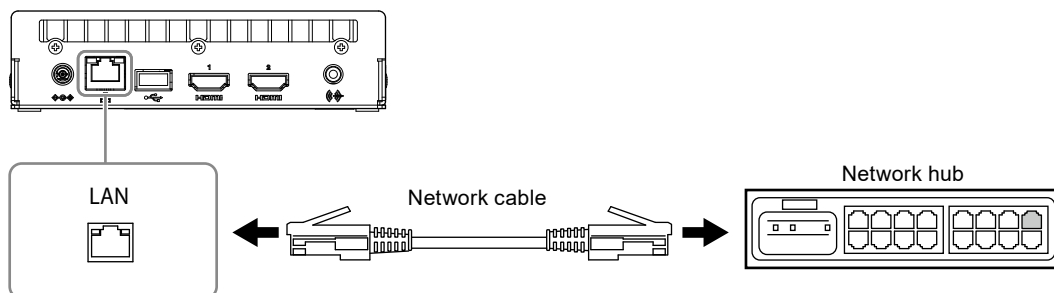

### Attention

- Use a 1000Base-T-compatible network hub.
- If the network hub supports PoE+, the product will operate from the network hub power supply.
- Use a straight cable of category 5e or above for the network cable.
- Configure the network in consideration of the communication performances of the various devices.
- Adjust the network camera settings so that the video image resolution reaches the level of resolution that can be input to this product. For the resolution that can be input, refer to "Input resolution" (page 33).

2. Connect the network camera to the network hub.

For connecting the network cameras and the network hub, refer to the network camera User's Manual.

### Connection example

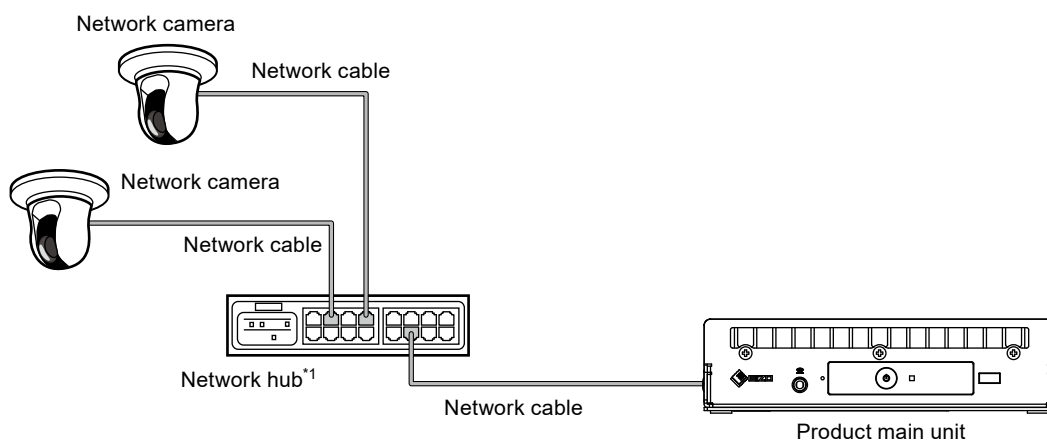

### Note

- A maximum of 48 network cameras can be registered.

# Connecting the Monitor

Connect a monitor that supports HDMI to this product. Connect the monitor that can display at a resolution listed in “Output resolution” (page 34).

## Attention

- This product has two HDMI terminals. (HDMI 1 and HDMI 2)
- Connect the monitor to HDMI 1 if “Multi-Monitor” under “Other” in “System” is set to “Single”. (The “Multi-Monitor” default value is set to “Extended”.)

## Connection example

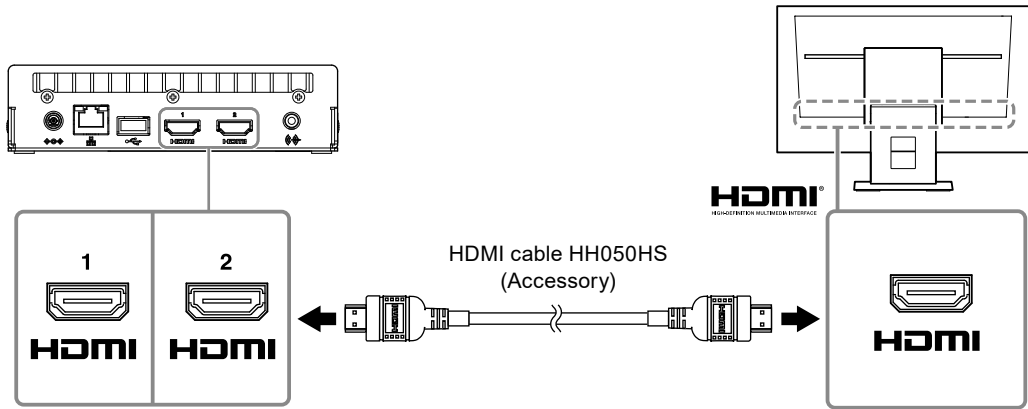

# Connecting Operating Devices

## ● Connecting a USB device

Connect a USB mouse, USB keyboard, or joystick to the USB downstream port.

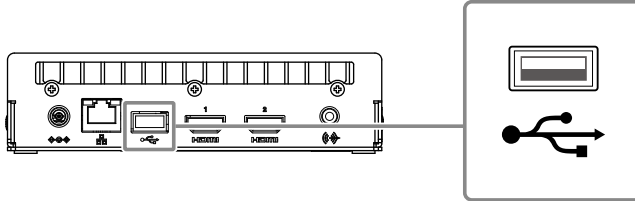

### Note

- Connecting to a device with USB hub function enables operation with multiple USB devices.
- Compatible joysticks are shown below.
  - AXIS T8311

## ● Connecting an AC Adapter (Separately Sold Option)

### Note

- This product supports the PoE+ function. If the connected network hub supports the PoE+ function, power is input from the LAN port. Therefore, there is no need to connect the AC adapter.
- When connected to both the AC adapter and a network hub that supports PoE+, power is supplied from the AC adapter.

- 1. Connect the power cord to the AC adapter.**
- 2. Connect the output terminal of the AC adapter to the DC input terminal of this product.**
- 3. Connect the power plug to the power outlet.**

### Attention

- Insert the power cord all the way into the power connector.
- Do not bundle cables when wiring.

# Turning On the Power

## 1. Press on the front of the product.

The power indicator lights up blue and the live image screen is displayed.

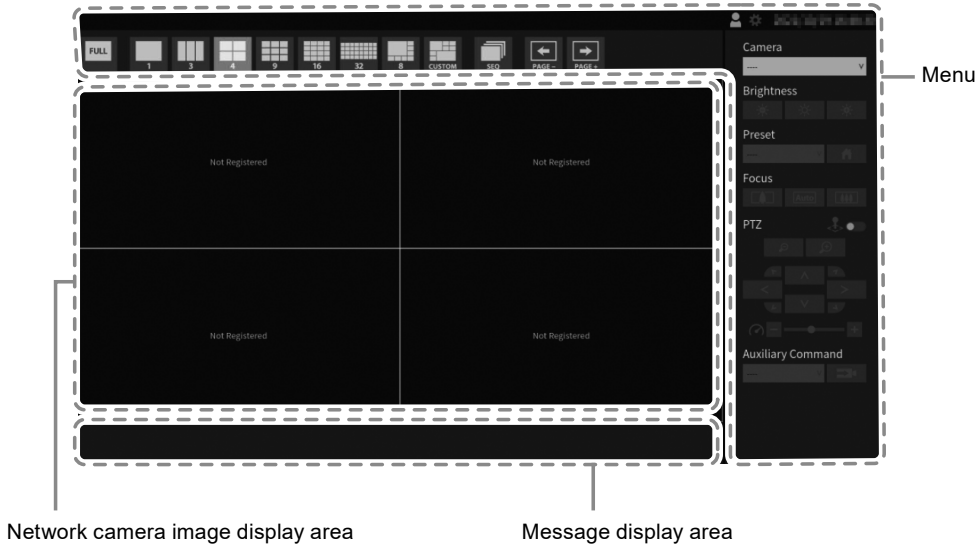

### Attention

- It takes approximately 1 minute for the live image screen to be displayed after the power is turned on. Do not turn off the power during startup.
- When no network camera is registered, a “Not Registered” message is displayed in the network camera image display area.

### Note

- By default, when power is input, the power indicator automatically flashes blue and the startup process takes place.
- To turn off the power, press  on the front of this product.



## ● Live Image Screen

Describes basic operation of live image screen. For details, refer to the “Instruction Manual”.

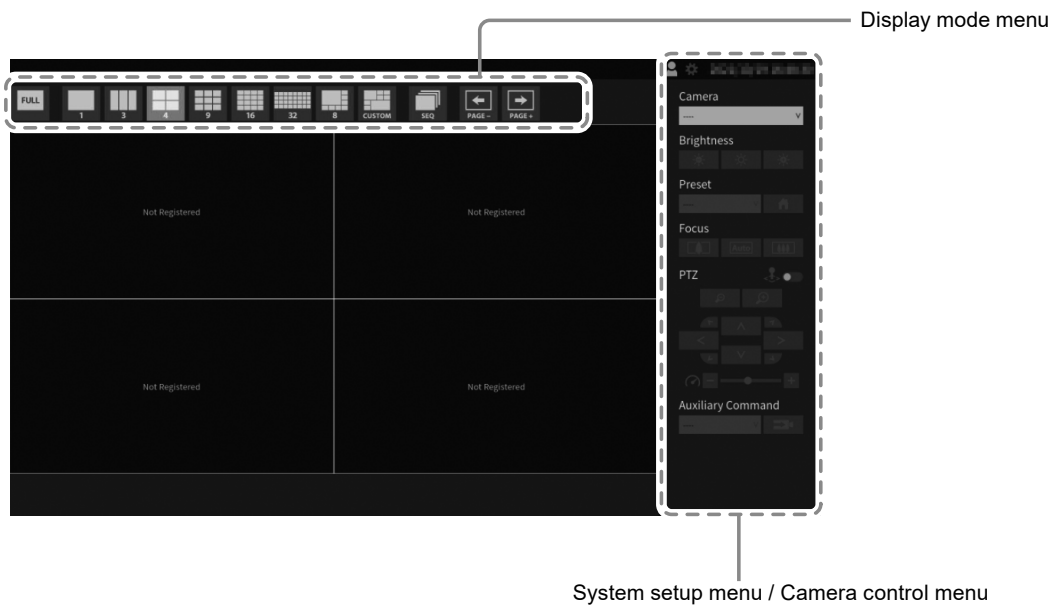

### Menu Operations

The various menus can be operated using a USB mouse, USB keyboard, or a joystick. If a menu is not displayed, click the screen with the USB mouse to display a menu.

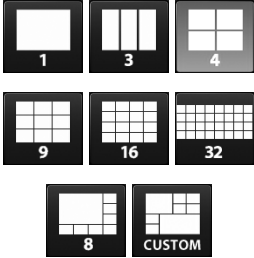

## Display mode menu

Camera images displayed on the live screen can be operated. With the Enterprise edition, the icons displayed can be changed from the setting screen. For details, see the “Installation Manual”.

Display mode menu (Default settings)	Shortcut key	Details
	F	Displays or hides the menu of the live image screen.
	L	Changes the live image screen layout.
	S	Turns the sequence of the camera image (mode that switches the display page at regular intervals) on or off.
	PageDown / PageUp	Changes the camera image page to display on the live image screen.

# Perform Initialization

This section describes settings to display network camera images on the monitor.

## Attention

- A USB mouse is required for initial settings. Settings cannot be performed with the remote control only.

## Note

- Initial settings can also be made from the Web browser of a computer connected to the same network. For details on setting from a Web browser, refer to the “Installation Manual”.

## ● Log In

### 1. Select (Login).

The login screen is displayed.

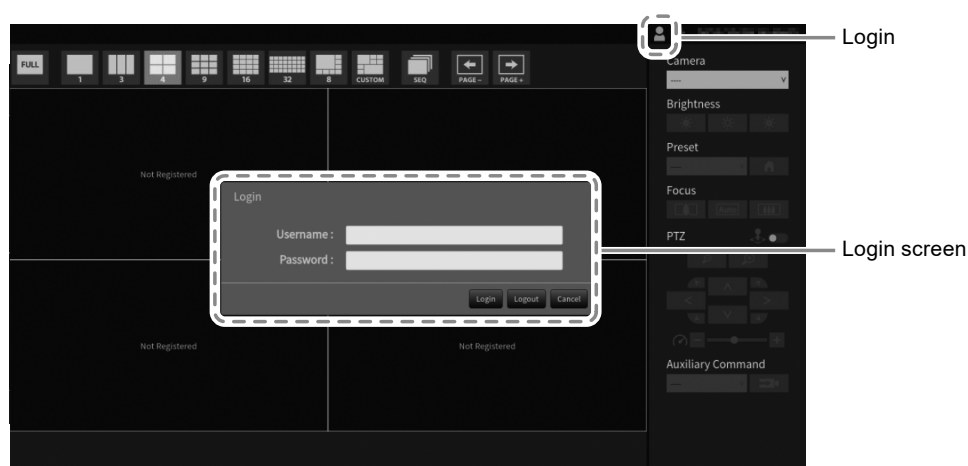

### 2. Enter “Username” and “Password”.

Enter the user name and password shown below and then press ENTER.

Username: “admin”

Password: “admin”

## Note

- The above user name and password are the default settings.
- When the “Account Type” is set to “LDAP”, you can temporarily change the account type when logging in by checking “Allow choosing of account type on the login dialog.” under “LDAP” in advance.

## Entering characters

- When entering using a USB mouse

Clicking an item that requires characters to be input, such as a text box, will display a software keyboard. When the focus is moved out of the software keyboard, the software keyboard is hidden.



- When entering using a USB keyboard

Entered characters are displayed in the text box.

## 3. Select “Login”.

The display returns to the live image screen where you can select  (Settings).

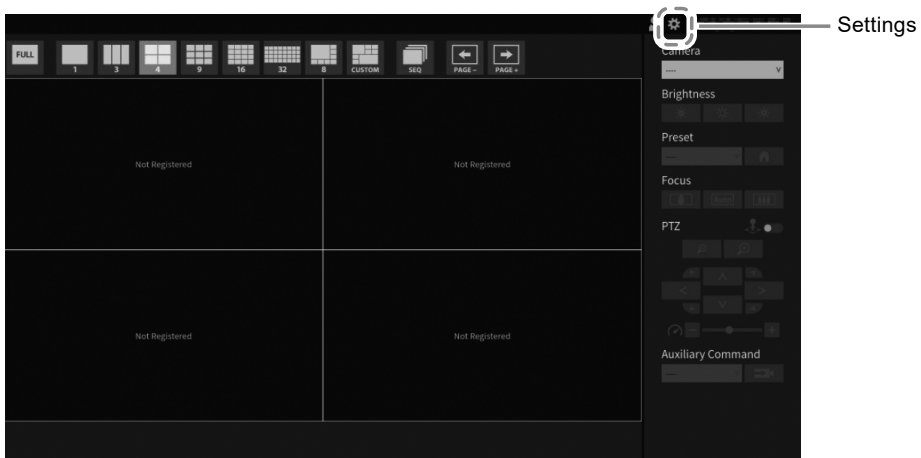

## ● Setting the Date and Time

### Attention

- Set the correct dates. Incorrect dates may result in failure of secure communication during certificate validation. If 802.1X is in use, or if you use SSL for LDAP settings or communication with the camera, avoid having the power turned off for an extended period and make sure the correct time is set using NTP.
- If secure LDAP communication is not established, you can not login. Reset the account setting using the Reset button.

### 1. Select (Settings).

The setting screen is displayed.

### 2. Select “Date and Time” under “System”.

The “Date and Time” screen is displayed.

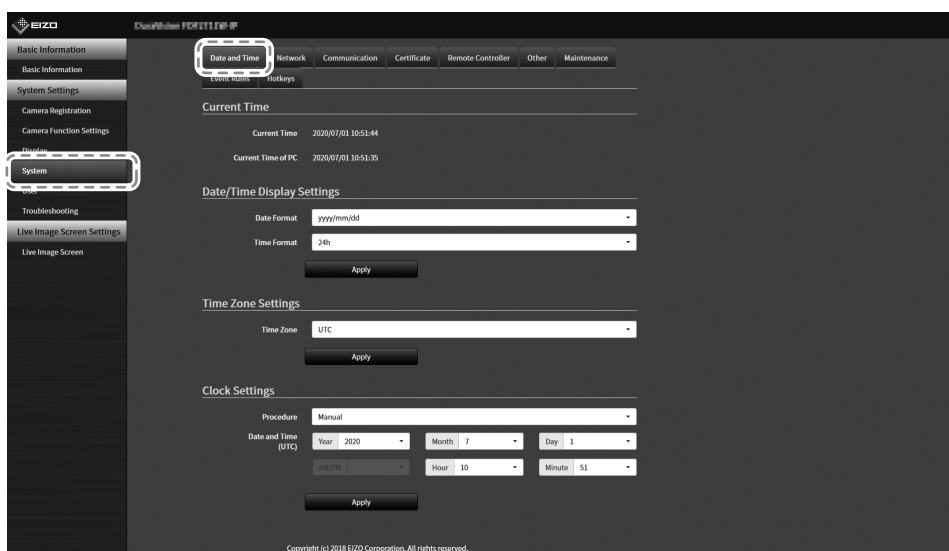

### 3. Set the current date and time.

#### Date/Time Display Settings

Item	Detail	Setting range
Date Format	Set the date format and time format.	yyyy/mm/dd, Mmm/dd/yyyy, dd/Mmm/yyyy, mm/dd/yyyy, dd/mm/yyyy
Time Format		

#### Time Zone Settings

Item	Detail	Setting range
Time Zone	Set the time zone.	Region / city

## Clock Settings

Item	Detail	Setting range
Procedure*1	Select the time setting procedure.	Manual / Synchronize with PC
Date and Time	Set the current time.	2018/1/1 0:00 to 2035/12/31 23:59

\*1 This can be set only when displayed on the web browser.

## 4. Select “Apply”.

The Setting Complete screen will be displayed, so select “OK”.

### Note

- When “Synchronize with PC” is selected for “Procedure”, the current date and time information of the computer is transmitted to this product.
- If the system is not connected to the power supply for one week or longer, the date and time displayed on this product will become incorrect. If such a situation occurs, reset the date and time.

## ● Performing Network Settings

### 1. Select (Settings).

The setting screen is displayed.

### 2. Select “Network” under “System”.

The “Network” screen is displayed.

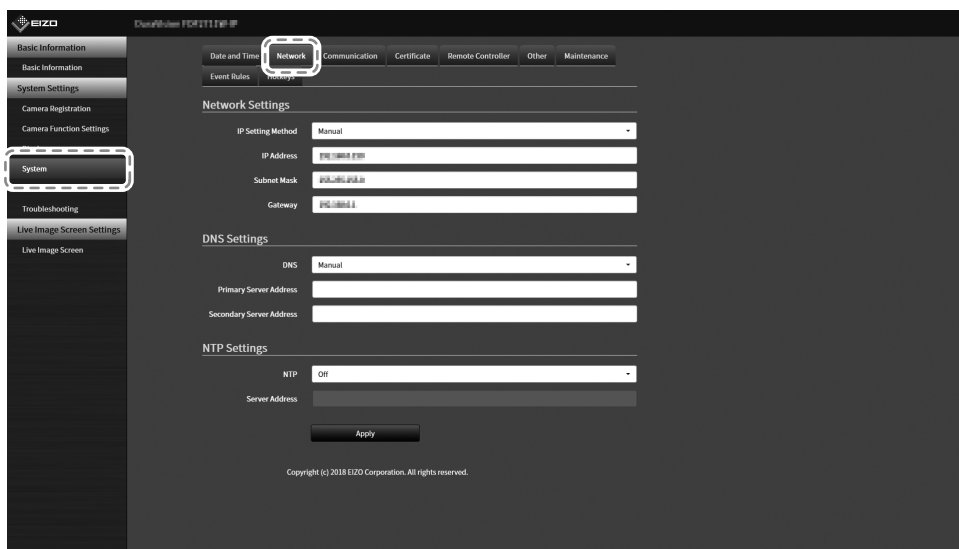

### 3. Set the following items.

#### Network Settings

Item	Detail	Setting range
IP Setting Method	Select "IP Setting Method".	DHCP / Manual
IP Address* <sup>1</sup>	When "Manual" is selected under "IP Setting Method", "IP Address", "Subnet Mask", and "Gateway" can be set.  <b>Attention</b> <ul style="list-style-type: none"> <li>• Avoid duplicate IP addresses for devices on the same network.</li> <li>• If multiple units of this product are connected on the same network, their IP addresses should be changed.</li> </ul>	0.0.0.1 to 255.255.255.254
Subnet Mask		
Gateway* <sup>2</sup>		

\*1 The initial address is "192.168.0.150".

\*2 If the environment does not include a gateway, it is not necessary to set "Gateway". Leave either as default setting or blank.

#### DNS Settings

Item	Detail	Setting range
DNS	(Only when "Manual" is selected under "IP Setting Method" of "Network Settings") Set "DNS".	Auto / Manual
Primary Server Address	When "Manual" is selected under "DNS", set "Primary Server Address" and "Secondary Server Address".	0.0.0.1 to 255.255.255.254
Secondary Server Address		

#### NTP Settings

Item	Detail	Setting range
NTP	Set whether to use the NTP server or not.	On / Off
Server Address	When "On" is selected, set the NTP server address.	Alphanumerics and symbols

For entering methods, refer to "Entering characters" (page 20).

### 4. Select "Apply".

The setting complete screen is displayed.

### 5. Select "OK".

## ● Registering a Camera Using Auto Discovery

Network cameras installed on the same network as this product can be automatically detected and registered.

### 1. Start network cameras.

For setting the network cameras, refer to the network camera User's Manual.

### 2. Select (Settings).

The setting screen is displayed.

### 3. Select “Camera Registration”.

A screen is displayed to show a list of camera registration information.

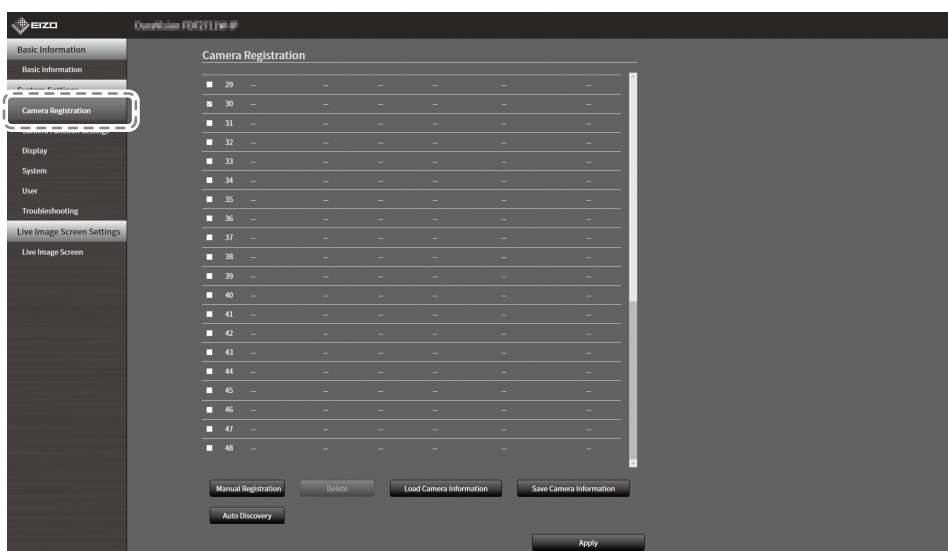

### 4. Select “Auto Discovery” in the lower part of the screen.

### 5. Select “Protocol”.

Select from “Panasonic”, “AXIS”, and “ONVIF”.

#### Attention

- To detect cameras with “AXIS” or “ONVIF”, it is necessary to build a network environment that enables Multicast communication in advance.

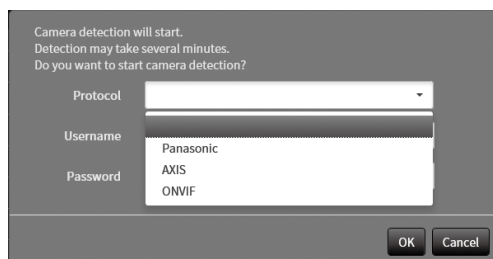



**6. Enter the network camera “Username” and “Password”, and select “OK”.**

Displays the detection results.

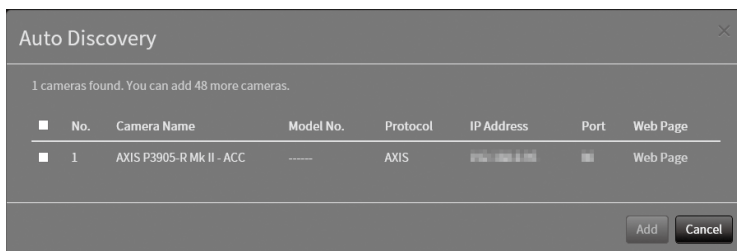

**7. Place a check in the camera to register, and select “Add”.**

The camera is registered.

**8. Select “Apply”.**

The setting complete screen is displayed.

**9. Select “OK”.**

## ● Registering a Camera Manually

Register manually if the camera does not support Auto Discovery.

### 1. Start network cameras.

For setting the network cameras, refer to the network camera User's Manual.

### 2. Select (Settings).

The setting screen is displayed.

### 3. Select “Camera Registration”.

A screen is displayed to show a list of camera registration information.

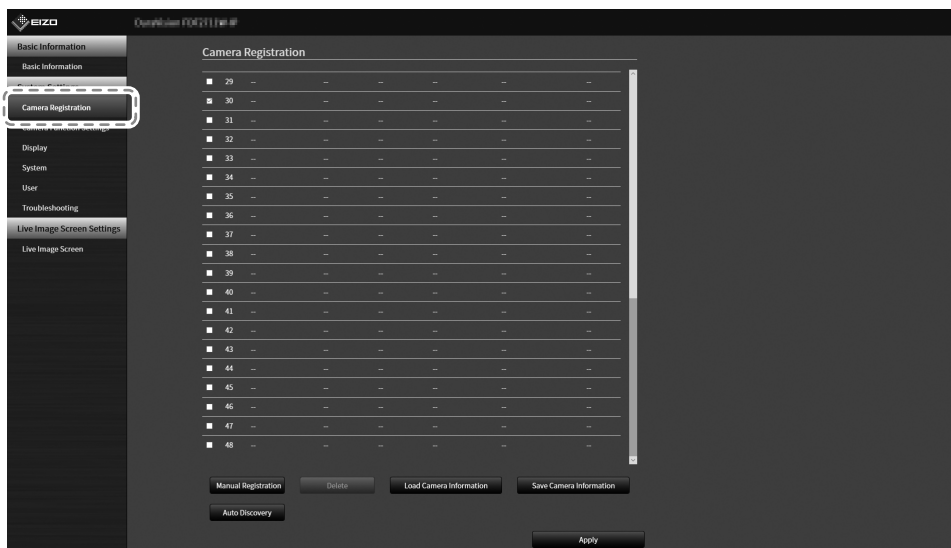

### 4. Select a position where the camera is to be registered.

Place a check mark on the check box of the position number where the camera is to be registered.

### 5. Select “Manual Registration”.

The “Camera Information Settings” dialog box is displayed.

## 6. Set each item and select “OK”.

Item	Detail	Setting range
Camera Name* <sup>1</sup>	Enter the camera name. If “Obtain Camera Name” is selected, the camera name is automatically obtained from the network camera.* <sup>2</sup> <b>Attention</b> • “Obtain Camera Name” cannot be used if Protocol is set to “DirectUri” or “SRT”.	Alphanumeric, kana* <sup>3</sup> , kanji* <sup>3</sup> (Up to 24 characters)
IP Address	Enter the IP address of the network camera.	0.0.0.1 to 255.255.255.254
“Ping” button	Executes a connection test with the camera (i.e. ping command).	-
Port	Enter the port number of the network camera.	1 to 65535* <sup>4</sup>
SSL* <sup>5</sup>	Provides secure communication.	-
Certificate Validation	Select certificate validation during SSL communication. <b>Attention</b> • If “Certificate Validation” is “On,” the Root Certificate of the network camera must be registered in “Root Certificate” of “Certificate”.	On / Off
Protocol	Select the protocol to control cameras.	Panasonic / AXIS / ONVIF / DirectUri / SRT* <sup>6</sup>
Username* <sup>7</sup>	Enter the user name to be used to access the network camera.	Alphanumerics and symbols (Up to 32 characters)
Password* <sup>7</sup>	Enter the password to be used to access the network camera.	Alphanumerics and symbols (Up to 32 characters)
Media Profile* <sup>8</sup>	Select the media profile of the network camera. If “Obtain Profile” is selected, the profile is automatically obtained from the network camera.	EIZO_Profile / Profile of each camera
Transmission Mode* <sup>8</sup>	Select the mode for transmitting camera images.	Unicast / Multicast

Item	Detail	Setting range
URI <sup>*9</sup>	When Protocol is set to "DirectURI", set a URI that starts with rtsp:// or rtp://. When Protocol is set to "SRT", set a URI that starts with srt://.	Alphanumerics (Up to 1023 characters)
Comm. Method <sup>*10</sup>	Select the communication method for camera video images.	RTP over UDP <sup>*11</sup> / RTP over RTSP / SRTP over UDP <sup>*12</sup> / MPEG2-TS over UDP <sup>*13</sup>
Stream <sup>*14</sup>	Select a stream format.	1 / 2 / 3 / 4
Channel <sup>*14</sup>	Select a stream channel.	1 / 2 / 3 / 4
RS485PTZ Control <sup>*14</sup>	Select whether or not PTZ operation is enabled for the camera that supports RS 485 communication.	On / Off
Video Stream <sup>*15</sup>	Select a video stream format.	Depends on the camera
Stream Profile <sup>*15</sup>	Select a stream profile.	Depends on the camera
Latency <sup>*16</sup>	Sets the latency.	20 ms to 8000 ms
Passphrase <sup>*16</sup>	Sets the passphrase.	Alphanumerics and symbols (Up to 79 characters)

\*1 Can only be acquired when "IP Address," "Port," "Username," and "Password" are entered.

\*2 The "Obtain Camera Name" does not display if Protocol is "DirectUri" or "SRT".

\*3 This can be used only when displayed on the Web browser.

\*4 When "Protocol" is set to "DirectUri" and "URI" starts with rtp://, the setting range will be 1824 to 65534 and an even number. When "Comm. Method" is "MPEG2-TS over UDP", the setting range will be 1024 to 65535.

\*5 Can only be set if "Protocol" is "Panasonic", "AXIS", or "ONVIF".

\*6 Can only be set in the Enterprise edition and when the extension "SRT" is enabled. In addition, only Caller is supported for the Connection mode.

\*7 Enter the username and password of the user who has the administrator's rights. For details, refer to the network camera User's Manual.

\*8 Can only be set if "Protocol" is "ONVIF".

\*9 Can only be set when Protocol is "DirectUri" or "SRT".

\*10 Can only be set if Protocol is "Panasonic", "AXIS", "ONVIF", or "DirectUri".

\*11 Only "RTP over UDP" can be set in the following situations.

- When "Protocol" is "ONVIF," and "Transmission Mode" is "Multicast"
- When "Protocol" is set to "DirectUri" and "rtp://Multicast Address" is correctly entered into URI

\*12 Can be set upon fulfilling all of the following conditions.

- Using "Enterprise" edition
- "Protocol" is "AXIS"
- "SSL" is checked
- Camera SRTP setting is enabled

\*13 This can be set only when "Protocol" is "DirectUri". When "Comm. Method" is set to "MPEG2-TS over UPD", items other than "Camera Name", "Port", "Protocol", and "Comm. Method" are disabled. To receive the stream in MPEG2-TS over UPD format, make the stream transmission settings for this product from the transmitter in advance.

\*14 This can be set only when "Protocol" is set to "Panasonic".

\*15 Can only be set if "Protocol" is "AXIS".

\*16 Can only be set if Protocol is "SRT".

---

**Note**

- To receive an MPEG2-TS stream with RTP, set “Protocol” to “DirectUri”, and set “Comm. Method” to “RTP over UDP” or “RTP over RTSP”.
  - To receive an MPEG2-TS stream with UDP, specify the port to receive the stream in “Port”, set “Protocol” to “DirectUri”, and set “Comm. Method” to “MPEG2-TS over UDP”. You should also make stream transmission settings for this product from the transmitter in advance.
- 

Returns to the screen that shows a list of camera registration information in the step 3 above.

## 7. Select “Apply”.

A confirmation message is displayed.

## 8. Select “OK”.

---

**Note**

- If there is a failure in obtaining “Obtain Camera Name” or “Obtain Profile” information, the following message is displayed. Check the settings again.

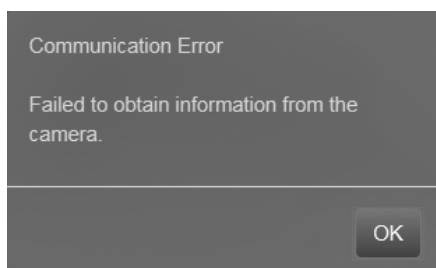

## ● Setting the Language

### 1. Select (Settings).

The setting screen is displayed.

### 2. Select “Other” under “System”.

The “Other” screen is displayed.

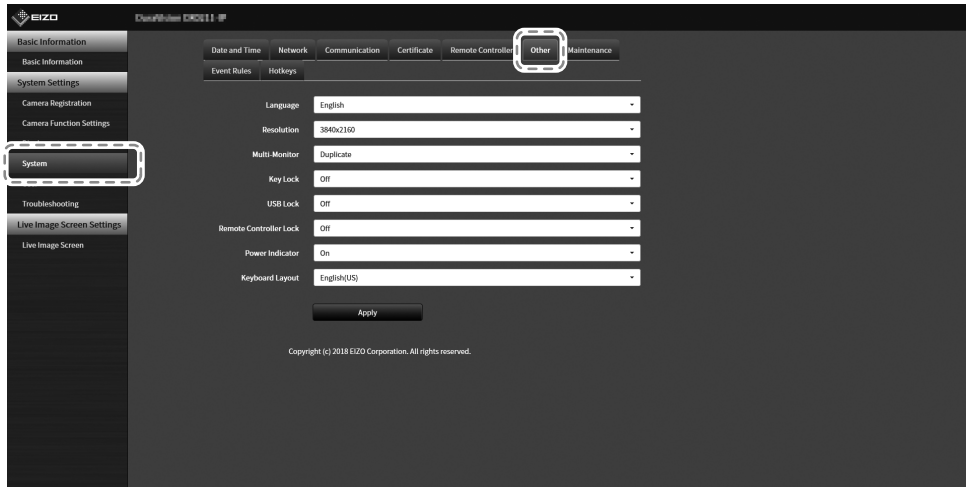

### 3. Select a language from the “Language” list box.

### 4. Select “Apply”.

The setting complete screen is displayed.

### 5. Select “OK”.

## Confirming the Software Version

### 1. Select (Settings).

The setting screen is displayed.

### 2. Select “Basic Information”.

The current software version is displayed in the system information.

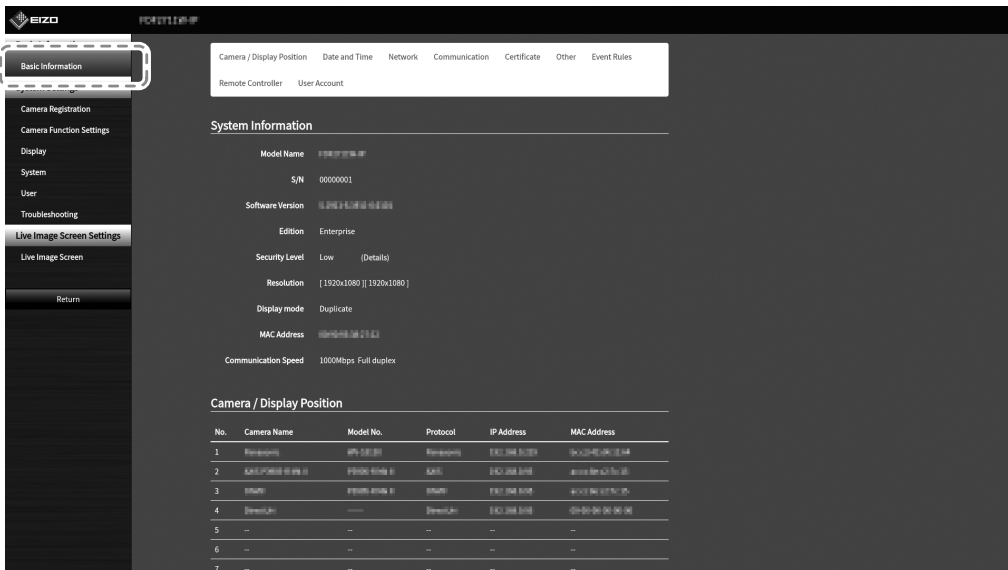

# Specifications

LAN	Standard	IEEE802.3ab (1000BASE-T), IEEE802.3u (100BASE-TX)		
	Communication speed	1000 Mbps, 100 Mbps		
Input signal (network)* <sup>1</sup>	Terminal	RJ-45		
	Video compression format	H.264 / H.265, MJPEG		
	Maximum resolution	H.264 / H.265	3840 × 2160* <sup>2</sup>	
		MJPEG	640 × 480	
	Maximum frame rate	60 fps* <sup>3</sup>		
	Maximum bit rate	8192 kbps		
	Number of displayed network cameras	Max. 32 units		
	Supported Protocols	RTSP, RTP, SRTP, SRT, DHCP, DNS, NTP, HTTP, HTTPS, LDAP, LDAPS, SNMP, 802.1X		
Supported streaming protocols	RTP (H.264, H.265, MJPEG, MPEG2-TS), SRTP (H.264, H.265), UDP (MPEG2-TS), SRT (H.264, H.265)			
Output signal (HDMI)	Output terminal	HDMI		
	Transmission system	TMDS (Single Link)		
USB	Port	Downstream port × 1		
	Standard	Compliant with USB Specification Revision 2.0		
	Communication speed	480 Mbps (high speed), 12 Mbps (full speed), 1.5 Mbps (low speed)		
	Power supply	Max. 500 mA		
Audio	Output Terminals* <sup>4</sup>	HDMI × 2 (shared with video signal)		
		Stereo mini jack × 1		
Power supply	Power supply input	12 VDC ±10 %, 2.0 A (DC input), IEEE 802.3at class 4 (PoE+ input)		
	Maximum power consumption	21.5 W or less (DC input), 25.5 W or less (PoE+ input)		
Physical specifications	Outside dimensions	165 mm × 44.2 mm × 130 mm (W × H × D)		
	Net weight	Approx. 770 g		
Operating environmental specifications	Temperature	0 °C to 40 °C		
	Humidity	20 % to 80 % R.H. (no condensation)		
	Air pressure	540 hPa to 1060 hPa		
Transportation/ storage environmental specifications	Temperature	-20 °C to 60 °C		
	Humidity	10 % to 90 % R.H. (no condensation)		
	Air pressure	200 hPa to 1060 hPa		

\*1 Interlaced video streaming cannot be displayed.

\*2 Images are not displayed when the maximum resolution is exceeded. Reduce the resolution and the bit rate for the network camera.

\*3 The maximum frame rate differs depending on the resolution. (Refer to “Input resolution” (page 33))

\*4 It is possible to output beep sounds when alerts are received.



## ● Compatible resolution

### Input resolution

This product supports the following resolutions of video images that can be displayed on the same screen.

#### H.264 / H.265 (when “Bit rate” is set to “4096 kbps”)

##### **The resolution of monitor : 1920 × 1080, 60 Hz**

1-screen display	3840 × 2160 / 30 fps, 1920 × 1080 / 60 fps, 1280 × 720 / 60 fps
4-screen display	3840 × 2160 / 20 fps, 1920 × 1080 / 60 fps, 1280 × 720 / 60 fps
9-screen display	1920 × 1080 / 30 fps, 1280 × 720 / 50 fps, 640 × 480 / 60 fps
12-screen display	1920 × 1080 / 20 fps, 1280 × 720 / 40 fps, 640 × 480 / 60 fps
16-screen display	1920 × 1080 / 20 fps, 1280 × 720 / 30 fps, 640 × 480 / 50 fps
32-screen display	1280 × 720 / 15 fps, 640 × 480 / 30 fps

##### **The resolution of monitor : 3840 × 2160, 60 Hz**

1-screen display	3840 × 2160 / 30 fps, 1920 × 1080 / 30 fps, 1280 × 720 / 30 fps
4-screen display	3840 × 2160 / 20 fps, 1920 × 1080 / 30 fps, 1280 × 720 / 30 fps
9-screen display	1920 × 1080 / 25 fps, 1280 × 720 / 30 fps, 640 × 480 / 30 fps
12-screen display	1920 × 1080 / 20 fps, 1280 × 720 / 25 fps, 640 × 480 / 30 fps
16-screen display	1920 × 1080 / 20 fps, 1280 × 720 / 25 fps, 640 × 480 / 30 fps
32-screen display	1280 × 720 / 15 fps, 640 × 480 / 20 fps

### MJPEG

640 × 480 / 30 fps

#### **Attention**

- The values above are provided for reference purposes. Video images are not displayed properly when display capability is exceeded because of network camera settings, network installation environment, or other reasons. If video images are not displayed properly, reduce the network camera resolution and the bit rate. Set the network cameras according to the User’s Manual of the camera used.
- MJPEG can only be supported when “Protocol” is “ONVIF”.

## Output resolution

The output resolutions from this product to the monitor are as follows.

Resolution	Vertical scan frequency [Hz]	Dot clock [MHz]
1920 × 1080	60	594.0 (max.)
1920 × 1080	59.94	
1920 × 1080	50	
2560 × 1440	59.951	
3840 × 2160	60	
3840 × 2160	59.94	
3840 × 2160	50	
3840 × 2160	30	
3840 × 2160	29.97	
3840 × 2160	25	

---

**Attention**

- When all of the following conditions are met, the refresh rate is limited to maximum 30Hz.
    - Two monitors are connected
    - Resolution is “3840 x 2160”
    - Multi-Monitor is set to “Extended”
    - Screen Orientation is set to “Portrait”
-

# ● Outline Dimensions

Unit: mm

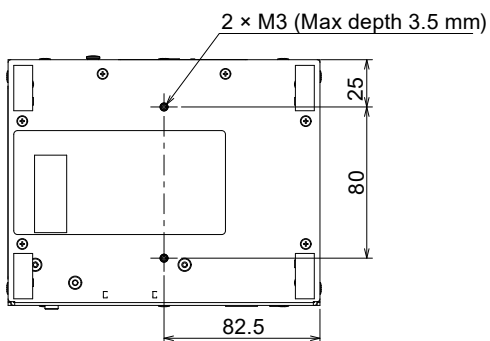
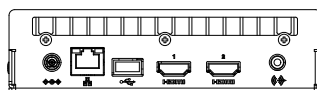
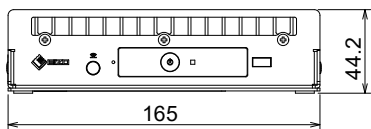
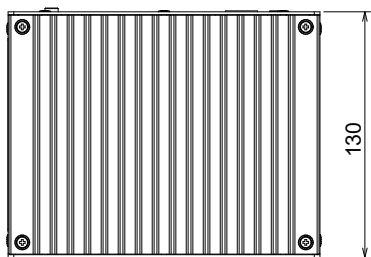

# Troubleshooting

## The Screen is not Displayed

Problem	Possible cause and remedy
<b>1. The screen is not displayed</b> <ul style="list-style-type: none"><li>Power indicator is not turned on</li></ul>	<ul style="list-style-type: none"><li>Is the power correctly connected? Connect to the AC adapter or to a network hub that supports PoE+.</li><li>Check whether the power cord of the AC adapter or the network hub is correctly connected.</li></ul>
<ul style="list-style-type: none"><li>Power indicator is on: red</li></ul>	<ul style="list-style-type: none"><li>Press  on the front of the product.</li></ul>
<ul style="list-style-type: none"><li>Power indicator is flashing red.</li></ul>	<ul style="list-style-type: none"><li>Connected to a PoE-compatible network hub but power is insufficient. Connect to a network hub that supports PoE+ or to the AC adapter (separately sold option).</li></ul>
<ul style="list-style-type: none"><li>Power indicator is on: blue</li></ul>	<ul style="list-style-type: none"><li>Check whether this product and the monitor are correctly connected using the HDMI cable. Connect to the HDMI 1 port, not the HDMI 2 port.</li><li>Pull out the HDMI cable and connect it again.</li><li>Check whether the input signal on the monitor is set to HDMI. Confirm that the monitor settings are correct. For details on the settings, refer to the User's Manual of the monitor.</li></ul>

# Imaging Problems

Problem	Possible cause and remedy
<b>1. The display images are not smooth / camera images are not displayed (when camera images are being displayed)</b>	<ul style="list-style-type: none"><li>• Reduce the resolution and/or bit rate set for the network camera. (For details, refer to the “Installation Manual”.)</li><li>• Check whether the used hubs and network cables are appropriate for handling the amount of information transmitted.</li><li>• Move to the setting screen and return to the live image screen.</li></ul>
<b>2. The camera images are not displayed properly on the live image screen about 30 seconds after turning the power off by pushing  on the main unit of the product</b>	<ul style="list-style-type: none"><li>• If the main power supply is turned on right after it is turned off, images may not be displayed properly for the first several minutes. After several minutes, the screen returns to a normal display.</li></ul>
<b>3. The time of the network camera and the time of the system do not match (when a camera images are being displayed)</b>	<ul style="list-style-type: none"><li>• On the setting screen, adjust the time of the network camera to match the time of this product. (For details, refer to the “Installation Manual”)</li></ul>

Problem	Possible cause and remedy
<p><b>4. An error message “E**-**” is displayed in the camera image display area</b></p>	<ul style="list-style-type: none"> <li>• When Communication failed (“E01-**”) <ul style="list-style-type: none"> <li>- A number of devices exceeding the allowable number of devices for simultaneous connection may be connected to the network camera. Disconnect other network devices accessing the camera or reduce the resolution of the camera. (For details, refer to the “Installation Manual”)</li> </ul> </li> <li>• When Communication failed (“E02-**”) <ul style="list-style-type: none"> <li>- Check whether a network cable is connected properly.</li> <li>- Check whether the network camera is turned on.</li> <li>- Check whether the username and password for the camera are set correctly in the system.</li> <li>- Isn't there an IP address conflict among this product and network cameras?</li> <li>- If “Certificate Validation” is enabled, is the certificate expiration date correct? (For details, refer to the “Installation Manual”)</li> </ul> </li> <li>• When Communication failed (“E03-**”) <ul style="list-style-type: none"> <li>- Network bandwidth may be overwhelmed or the display capability of this product may have been exceeded. Reduce the resolution and/or bit rate set for the network camera. (For details, refer to the “Installation Manual”.)</li> </ul> </li> <li>• When in Incompatible resolution (“E04-**”) <ul style="list-style-type: none"> <li>- A resolution which is incompatible with this product may be set. Try changing the resolution of the network camera.</li> </ul> </li> <li>• When Compression format is mismatched (“E05-**”) <ul style="list-style-type: none"> <li>- The streaming format from the network camera may be different from that of this product. Check the settings of the camera and this product and then restart this product.</li> </ul> </li> <li>• When Unapproved parameters (“E06-**”) <ul style="list-style-type: none"> <li>- The Multicast setting value may not be set correctly. Check the settings of the camera.</li> </ul> </li> <li>• If it is a network connection error (E07-**): <ul style="list-style-type: none"> <li>- This product may not be connected to the network, possibly LAN cable is not connected. Check the network connection.</li> </ul> </li> <li>• E08-** <ul style="list-style-type: none"> <li>- There is no available license for using network camera protocols. Please check the license.</li> </ul> </li> <li>• E09-** <ul style="list-style-type: none"> <li>- The size of the data you want to play back may exceed the download limit for this product. Try changing the recording time and settings for the network camera.</li> <li>- The data you want to play back may be in a format that this product does not support. Check the network camera settings.</li> </ul> </li> </ul>

# Setting Problems

Problem	Possible cause and remedy
1. Cannot log in	<ul style="list-style-type: none"> <li>• Enter the user name and password again.</li> <li>• Reset the account information using the Reset button and log in as the default setting account. (For details, refer to “Controls and Functions” (page 10))</li> </ul>
2. Cannot display the setting screen	<ul style="list-style-type: none"> <li>• It is necessary to log in as a user with a user level of “ADMIN”.</li> <li>• A USB mouse is required for initial settings. Settings cannot be performed with the remote control only.</li> </ul>
3. Only one camera is recognized when using a video encoder that supports multiple channels	<ul style="list-style-type: none"> <li>• Manually register the number of channels that will be used. (For details, refer to the “Installation Manual”)</li> </ul>
4. A communication error message is displayed when “Apply” is selected for network camera manual registration	<ul style="list-style-type: none"> <li>• There may be a problem with network camera communication.</li> <li>• Check the network connection status and camera registration details.</li> </ul>
5. Cannot register a new user	<ul style="list-style-type: none"> <li>• Duplicate user names cannot be registered.</li> <li>• Only up to 10 users can be registered. Check whether 10 users have already been registered. (For details, refer to the “Installation Manual”)</li> <li>• Check that you have entered correct user name and password for the security camera.</li> </ul>
6. Cannot delete a user	<ul style="list-style-type: none"> <li>• If only one user is registered as the “ADMIN” user level, it cannot be deleted. At least one user is required as the “ADMIN” user. Check the registered user information. (For details, refer to the “Installation Manual”)</li> </ul>
7. Cannot communicate with the camera	<ul style="list-style-type: none"> <li>• Check the settings of the network camera and the system. For details, contact the system administrator.</li> </ul>
8. The set date and time are not displayed correctly	<ul style="list-style-type: none"> <li>• If the system is not connected to the power supply for one week or longer, the date and time will not be displayed correctly. In such a case, set the date and time again. (For details, refer to the “Installation Manual”)</li> </ul>
9. Web browser screen cannot be displayed	<ul style="list-style-type: none"> <li>• Check if there is no conflict of IP addresses for devices on the same network. Connecting multiple units of this product to the same network without changing their default values will result in an IP address conflict. For information on network settings, refer to “Performing Network Settings” (page 22).</li> </ul>
10. Enterprise license activation failed	<ul style="list-style-type: none"> <li>• Please send the error code, model name, serial number, product firmware version, and failed activation file to the license provider.</li> </ul>

# Other Problems

Problem	Possible cause and remedy
<b>1. The mouse / keyboard does not work</b>	<ul style="list-style-type: none"><li>• Check whether the USB cable is connected properly.</li><li>• Pull out the USB cable and connect it again.</li><li>• Isn't the USB lock function enabled? (For details, refer to the "Installation Manual")</li></ul>
<b>2. The mouse / keyboard responses lag</b>	<ul style="list-style-type: none"><li>• Reduce the resolution and/or bit rate set for the network camera (for details, refer to your User's Manual of the network camera or Installation Manual of this product).</li></ul>
<b>3. The network camera display position cannot be changed</b>	<ul style="list-style-type: none"><li>• The user level authorized to operate the camera is "CAMERA CONTROL" or "ADMIN". (For details, refer to the "Installation Manual".)</li><li>• Display position of the network camera cannot be changed during sequential display. (For details, refer to the "Installation Manual".)</li></ul>
<b>4. Restarts all of a sudden</b>	<ul style="list-style-type: none"><li>• When the temperature inside the product rises high, this product may restart repeatedly. Check the temperature around this product. The internal temperature may rise high when the product is used in a narrow or poorly ventilated place or when the product is used with an object placed on top of it.</li></ul>



## Warning for Radio Interference

For U.S.A., Canada Only

### FCC Supplier's Declaration of Conformity

We, the Responsible Party

EIZO Inc.

5710 Warland Drive, Cypress, CA 90630

Phone: (562) 431-5011

declare that the product

Trade name: EIZO

Model: DuraVision DX0211-IP

is in conformity with Part 15 of the FCC Rules. Operation of this product is subject to the following two conditions: (1) this device may not cause harmful interference, and (2) this device must accept any interference received, including interference that may cause undesired operation.

### WARNING!

This equipment has been tested and found to comply with the limits for a Class A digital device, pursuant to Part 15 of the FCC Rules. These limits are designed to provide reasonable protection against harmful interference when the equipment is operated in a commercial environment. This equipment generates, uses, and can radiate radio frequency energy and if not installed and used in accordance with the instruction manual, may cause harmful interference to radio communications. Operation of this equipment in a residential area is likely to cause harmful interference in which case the user will be required to correct the interference at his own expense.

Changes or modifications not expressly approved by the party responsible for compliance could void the user's authority to operate the equipment.

### Note

Use the attached specified cable below or EIZO signal cable with this product so as to keep interference within the limits of a Class A digital device.

- AC Adapter
- Shielded Signal Cable (enclosed)

### Canadian Notice

This Class A information technology equipment complies with Canadian ICES-003.  
Cet équipement informatique de classe A est conforme à la norme NMB-003 du Canada.

## For Europe, Australia, New Zealand, etc Only

---

### **Warning**

Operation of this equipment in a residential environment could cause radio interference.

### **Warnung**

Der Betrieb dieses Geräts in einer Wohnumgebung konnte Funkstörungen verursachen.

### **Avertissement**

L'utilisation de cet équipement dans une zone résidentielle pourrait provoquer des interférences radio.

# LIMITED WARRANTY

EIZO Corporation (hereinafter referred to as “**EIZO**”) and distributors authorized by EIZO (hereinafter referred to as the “**Distributors**”) warrant, subject to and in accordance with the terms of this limited warranty (hereinafter referred to as the “**Warranty**”), to the original purchaser (hereinafter referred to as the “**Original Purchaser**”) who purchased the product specified in this document (hereinafter referred to as the “**Product**”) from EIZO or Distributors, that EIZO and Distributors shall, at their sole discretion, either repair or replace the Product at no charge if the Original Purchaser becomes aware within the Warranty Period (defined below) that the Product malfunctions or is damaged in the course of normal use of the Product in accordance with the description in the instruction manual of the Product (hereinafter referred to as the “**User’s Manual**”).

The period of this Warranty is two (2) years from the date of purchase of the Product (hereinafter referred to as the “**Warranty Period**”). EIZO and Distributors shall bear no liability or obligation with regard to the Product in relation to the Original Purchaser or any third parties other than as provided under this Warranty. EIZO and Distributors will cease to hold or store any parts (excluding design parts) of the Product upon expiration of seven (7) years after the production of the Product is discontinued. In repairing the monitor, EIZO and Distributors will use renewal parts which comply with our QC standards. If the unit cannot be repaired due to its condition or the stockout of a relevant part, EIZO and Distributors may offer the replacement by a product with equivalent performance instead of repairing it.

The Warranty is valid only in the countries or territories where the Distributors are located. The Warranty does not restrict any legal rights of the Original Purchaser.

Notwithstanding any other provision of this Warranty, EIZO and Distributors shall have no obligation under this Warranty whatsoever in any of the cases as set forth below:

- (a) Any defect of the Product caused by freight damage, modification, alteration, abuse, misuse, accident, incorrect installation, disaster, adherent dust, faulty maintenance and/or improper repair by third party other than EIZO and Distributors;
- (b) Any incompatibility of the Product due to possible technical innovations and/or regulations;
- (c) Any deterioration of the sensor, including measurement value of the sensor;
- (d) Any defect of the Product caused by external equipments;
- (e) Any defect of the Product caused by the use under environmental conditions other than EIZO and Distributors’ estimation;
- (f) Any deterioration of the attachments of the Product (e.g. cables, User’s Manual, CD-ROM, etc.);
- (g) Any deterioration of the consumables, and/or accessories of the Product (e.g. batteries, remote controller, touch pen, etc.);
- (h) Any deformation, discoloration, and/or warp of the exterior of the Product;
- (i) Any defect of the Product caused by placement in a location where it may be affected by strong vibration or shocks;
- (j) Any deterioration or malfunction of the cooling fan caused by adherent dust.

To obtain service under the Warranty, the Original Purchaser must deliver the Product, freight prepaid, in its original package or other adequate package affording an equal degree of protection, assuming the risk of damage and/or loss in transit, to the local Distributor. The Original Purchaser must present proof of purchase of the Product and the date of such purchase when requesting services under the Warranty.

The Warranty Period for any replaced and/or repaired product under this Warranty shall expire at the end of the original Warranty Period.

**EIZO OR DISTRIBUTORS ARE NOT RESPONSIBLE FOR ANY DAMAGE TO, OR LOSS OF, DATA OR OTHER INFORMATION STORED IN ANY MEDIA OR ANY PART OF ANY PRODUCT RETURNED TO EIZO OR DISTRIBUTORS FOR REPAIR.**

**EIZO AND DISTRIBUTORS MAKE NO FURTHER WARRANTIES, EXPRESSED OR IMPLIED, WITH RESPECT TO THE PRODUCT AND ITS QUALITY, PERFORMANCE, MERCHANTABILITY OR FITNESS FOR ANY PARTICULAR USE. IN NO EVENT SHALL EIZO OR DISTRIBUTORS BE LIABLE FOR ANY INCIDENTAL, INDIRECT, SPECIAL, CONSEQUENTIAL OR OTHER DAMAGE WHATSOEVER (INCLUDING, WITHOUT LIMITATION, DAMAGES FOR LOSS OF PROFIT, BUSINESS INTERRUPTION, LOSS OF BUSINESS INFORMATION, OR ANY OTHER PECUNIARY LOSS) ARISING OUT OF THE USE OR INABILITY TO USE THE PRODUCT OR IN ANY CONNECTION WITH THE PRODUCT, WHETHER BASED ON CONTRACT, TORT, NEGLIGENCE, STRICT LIABILITY OR OTHERWISE, EVEN IF EIZO OR DISTRIBUTORS HAVE BEEN ADVISED OF THE POSSIBILITY OF SUCH DAMAGES. THIS EXCLUSION ALSO INCLUDES ANY LIABILITY WHICH MAY ARISE OUT OF THIRD PARTY CLAIMS AGAINST THE ORIGINAL PURCHASER. THE ESSENCE OF THIS PROVISION IS TO LIMIT THE POTENTIAL LIABILITY OF EIZO AND DISTRIBUTORS ARISING OUT OF THIS LIMITED WARRANTY AND/OR SALES.**

# Recycling Information / Informationen zum Thema Recycling / Informations sur le recyclage / Сведения по утилизации

English

Deutsch

Français

Русский

## Recycling Information

This product, when disposed of, is supposed to be collected and recycled according to your country's legislation to reduce environmental burden. When you dispose of this product, please contact a distributor or an affiliate in your country.

The contact addressees are listed on the EIZO website below.

[www.eizoglobal.com](http://www.eizoglobal.com)

For recycling information for customers in Switzerland, please refer to the following website.

[www.swico.ch](http://www.swico.ch)

## Informationen zum Thema Recycling

Dieses Produkt muss gemäß den Vorschriften Ihres Landes zur Entlastung der Umwelt recyclet werden. Wenden Sie sich bei der Entsorgung dieses Produkts an einen Verteiler oder eine Tochtergesellschaft in Ihrem Land.

Die Adressen zur Kontaktaufnahme sind auf der unten angegebenen Website von EIZO aufgeführt.

[www.eizoglobal.com](http://www.eizoglobal.com)

Kunden in der Schweiz entnehmen Informationen zum Recycling der folgenden Website:

[www.swico.ch](http://www.swico.ch)

## Informations sur le recyclage

Ce produit doit être jeté aux points de collecte prévus à cet effet et recyclé conformément à la législation de votre pays, afin de réduire l'impact sur l'environnement. Lorsque vous jetez ce produit, veuillez contacter un distributeur ou une société affiliée de votre pays.

Les adresses des distributeurs sont répertoriées sur le site Web EIZO ci-dessous.

[www.eizoglobal.com](http://www.eizoglobal.com)

Pour les clients en Suisse, veuillez consulter le site Web suivant afin d'obtenir des informations sur le recyclage.

[www.swico.ch](http://www.swico.ch)

## Información sobre reciclaje

Este producto debe desecharse y reciclarse según la legislación del país para reducir el impacto medioambiental. Cuando desee deshacerse de este producto, póngase en contacto con un distribuidor o una filial de su país.

Encontrará las direcciones de contacto en el sitio web de EIZO que se indica a continuación.

[www.eizoglobal.com](http://www.eizoglobal.com)

## Informazioni sul riciclaggio

Per lo smaltimento e il riciclaggio del presente prodotto, attenersi alle normative vigenti nel proprio paese per ridurre l'impatto ambientale. Per lo smaltimento, rivolgersi ad un distributore o un affiliato presenti nel proprio paese.

Gli indirizzi sono elencati nel sito Web EIZO riportato di seguito.

[www.eizoglobal.com](http://www.eizoglobal.com)

Per informazioni sul riciclaggio per i clienti in Svizzera, consultare il sito Web riportato di seguito.

[www.swico.ch](http://www.swico.ch)

## Återvinningsinformation

När denna produkt kasseras ska den hanteras och återvinnas enligt landets föreskrifter för att reducera miljöpåverkan. När du kasserar produkten ska du kontakta en distributör eller representant i ditt land.

Kontaktadresserna listas på EIZO-webbplatsen nedan.

[www.eizoglobal.com](http://www.eizoglobal.com)

## Πληροφορίες ανακύκλωσης

Το προϊόν αυτό, όταν απορρίπτεται, πρέπει να συλλέγεται και να ανακυκλώνεται σύμφωνα με τη νομοθεσία της χώρας σας έτσι ώστε να μην επιβαρύνει το περιβάλλον. Για να απορρίψετε το προϊόν, επικοινωνήστε με έναν αντιπρόσωπο ή μια θυγατρική εταιρεία στη χώρα σας.

Οι διευθύνσεις επικοινωνίας αναγράφονται στην τοποθεσία web της EIZO παρακάτω.

[www.eizoglobal.com](http://www.eizoglobal.com)

## Сведения по утилизации

По истечении срока службы данного продукта его следует принести на сборный пункт и утилизировать в соответствии с действующими предписаниями в вашей стране, чтобы уменьшить вредное воздействие на окружающую среду. Прежде чем выбросить данный продукт, обратитесь к дистрибьютору или в местное представительство компании в вашей стране.

Контактные адреса можно найти на веб-узле EIZO.

[www.eizoglobal.com](http://www.eizoglobal.com)

## Informatie over recycling

Wanneer u dit product wilt weggooien, moet het uit milieu-overwegingen worden verzameld en gerecycled volgens de betreffende wetgeving van uw land. Wanneer u dit product wilt weggooien, moet u contact opnemen met een distributeur of een partner in uw land.

De contactadressen worden vermeld op de volgende EIZO-website.

[www.eizoglobal.com](http://www.eizoglobal.com)

## Informação sobre reciclagem

Este produto, quando o deitar fora, deve ser recolhido e reciclado de acordo com a legislação do seu país para reduzir a poluição. Quando deitar fora este produto, contacte um distribuidor ou uma filial no seu país. Os endereços de contacto estão listados no website do EIZO, abaixo.

[www.eizoglobal.com](http://www.eizoglobal.com)

## Oplysninger om genbrug

Dette produkt forventes ved bortskaffelse at blive indsamlet og genbrugt i overensstemmelse med lovgivningen i dit land for at reducere belastningen af miljøet. Når du bortskaffer denne produkt, skal du kontakte en distributør eller et tilknyttet selskab i dit land.

Adresserne på kontaktpersonerne er angivet på EIZO's websted nedenfor.

[www.eizoglobal.com](http://www.eizoglobal.com)

## Kierrätystä koskevia tietoja

Tuote tulee hävittää kierrättämällä maan lainsäädännön mukaisesti ympäristön kuormittumisen vähentämiseksi. Kun hävität tuotteen, ota yhteyttä jälleenmyyjään tai tytäryhtiöön maassasi.

Yhteystiedot löytyvät EIZO:n Internet-sivustolta.

[www.eizoglobal.com](http://www.eizoglobal.com)

## Wykorzystanie surowców wtórnych

Ten produkt po zużyciu powinien być zbierany i przetwarzany zgodnie z krajowymi przepisami dotyczącymi ochrony środowiska. Wyrzucając ten produkt, należy skontaktować się z lokalnym dystrybutorem lub partnerem. Adresy kontaktowe można znaleźć we wskazanej poniżej witrynie internetowej firmy EIZO.

[www.eizoglobal.com](http://www.eizoglobal.com)

## Informace o recyklaci

Při likvidaci produktu musí být produkt vyzvednut a recyklován podle zákonů příslušné země, aby nedocházelo k zatěžování životního prostředí. Zbavujete-li se produktu, kontaktujte distributora nebo pobočku ve své zemi. Kontaktní adresy jsou uvedeny na následující webové stránce společnosti EIZO.

[www.eizoglobal.com](http://www.eizoglobal.com)

## Ringlussevõtu alane teave

Keskonnakoormuse vähendamiseks tuleks kasutatud tooted kokku koguda ja võtta ringlusse vastavalt teie riigi seadustele. Kui kõrvaldate käesoleva toote, võtke palun ühendust turustaja või filiaaliga oma riigis.

Kontaktisikud on toodud EIZO veebilehel järgmisel aadressil:

[www.eizoglobal.com](http://www.eizoglobal.com)

## Újrahasznosítási információ

Jelen terméket, amikor eldobjuk, az illető ország törvényei alapján kell összegyűjteni és újrahasznosítani, hogy csökkentsük a környezet terhelését. Amikor ezt a terméket eldobja, kérjük lépjen kapcsolatba egy országon belül forgalmazóval vagy társvállalkozással.

A kapcsolat címei az EIZO alábbi weboldalán található felsorolva:

[www.eizoglobal.com](http://www.eizoglobal.com)

## Podatki o recikliranju

Ob koncu uporabe odslužen izdelek izročite na zbirno mesto za recikliranje v skladu z okoljevarstveno zakonodajo vaše države. Prosimo, da se pri odstranjevanju izdelka obrnete na lokalnega distributerja ali podružnico.

Kontaktne naslovi so objavljeni na spodaj navedenih spletnih straneh EIZO:

[www.eizoglobal.com](http://www.eizoglobal.com)

## Informácie o recyklácii

Pri likvidácii musí byť tento výrobok recyklovaný v súlade s legislatívou vašej krajiny, aby sa znížilo zaťaženie životného prostredia. Keď sa chcete zbaviť tohto výrobku, kontaktujte prosím distribútora alebo pobočku vo vašej krajine.

Zoznam kontaktných adries je uvedený na nasledovnej webovej stránke firmy EIZO:

[www.eizoglobal.com](http://www.eizoglobal.com)

## Pārstrādes informācija

Utilizējot šo produktu, tā savākšana un pārstrāde veicama atbilstoši jūsu valsts likumdošanas prasībām attiecībā uz slodzes uz vidi samazināšanu. Lai veiktu šī produkta utilizāciju, sazinieties ar izplatītāju vai pārstāvniecību jūsu valstī.

Kontaktadreses ir norādītas zemāk minētajā EIZO tīmekļa vietnē.

[www.eizoglobal.com](http://www.eizoglobal.com)

## Informacija apie gražinamąjį perdirbimą

Šalinant (išmetant) šiuos gaminius juos reikia surinkti ir perdirbti gražinamuoju būdu pagal jūsų šalies teisės aktus, siekiant sumažinti aplinkos teršimą. Kai reikia išmesti šį gaminį, kreipkitės į jūsų šalyje veikiančią gaminių pardavimo atstovybę arba jos filialą.

Kontaktiniai adresatai nurodyti EIZO interneto svetainėje.

[www.eizoglobal.com](http://www.eizoglobal.com)

## Информация относительно рециклиране

При изхвърлянето на този продукт се предлага събирането и рециклирането му съобразно законите на вашата страна за да се намали замърсяването на околната среда. Когато искате да се освободите от този продукт, моля свържете се с търговския му представител или със съответните органи отговарящи за това във вашата страна.

Данните за връзка с нас са описани на следния Интернет сайт на EIZO:

[www.eizoglobal.com](http://www.eizoglobal.com)

## Informație referitoare la reciclare

Acest produs, când debarasat, trebuie colectat și reciclat conform legislației țării respective ca să reducem sarcina mediului. Când se debarasează de acest produs, vă rugăm să contactați un distribuitor sau un afiliat al țării respective.

Adresele de contact le găsiți pe pagina de web al EIZO:

[www.eizoglobal.com](http://www.eizoglobal.com)

## معلومات عن إعادة التدوير

عند التخلص من هذا المنتج، من الضروري تجميعه وإعادة تدويره وفقاً للقوانين المتبعة في بلدك لتقليل العبء المسلط على البيئة. عندما تتخلص من هذا المنتج، يرجى الاتصال بموزع أو طرف متسبب إليه في بلدك. عناوين الاتصال مدرجة في موقع ايزو EIZO ادناه على شبكة الانترنت.

[www.eizoglobal.com](http://www.eizoglobal.com)

## Geri Dönüşüm Bilgisi

Bu ürünün, atılacağı zaman, ülkenizin çevre kirliliğinin azaltılması konusundaki mevzuatına göre toplanması ve yeniden değerlendirilmesi gerekmektedir. Ürünü atacağınız zaman lütfen ülkenizdeki bir distribütör veya ilgili kuruluşla temasa geçiniz.

İrtibat adresleri aşağıdaki EIZO web sitesinde verilmiştir.

[www.eizoglobal.com](http://www.eizoglobal.com)

English

Deutsch

Français

Русский





## **EIZO Corporation**

153 Shimokashiwano, Hakusan, Ishikawa 924-8566 Japan

## **EIZO Europe GmbH**

Belgrader Straße 2, 41069 Mönchengladbach, Germany

## **艺卓显像技术(苏州)有限公司**

中国苏州市苏州工业园区展业路 8 号中新科技工业坊 5B

[www.eizoglobal.com](http://www.eizoglobal.com)

00N0N120E1  
SUM-DX0211-IP-AL