

OUTLINE DIMENSIONS

MODEL EV2457

UNIT mm

EIZO Corporation

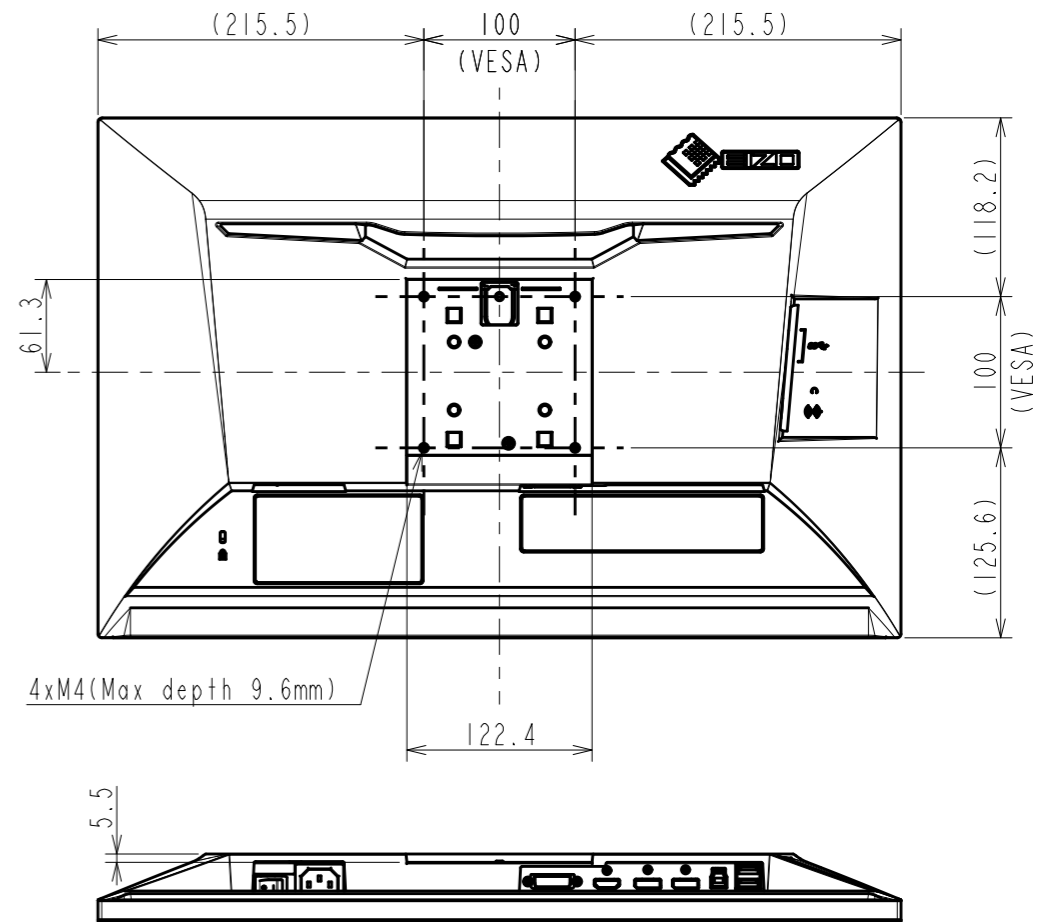
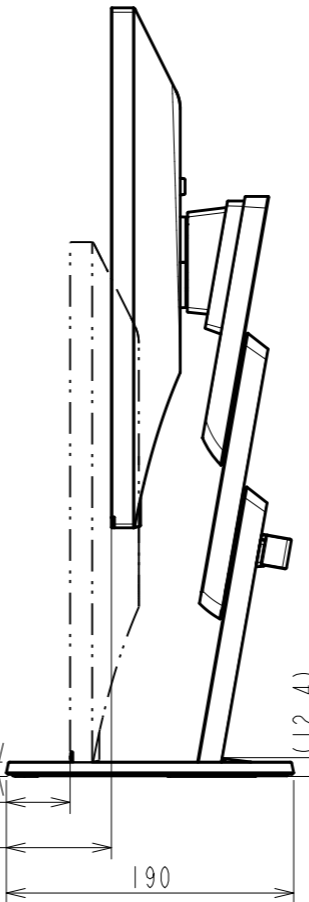
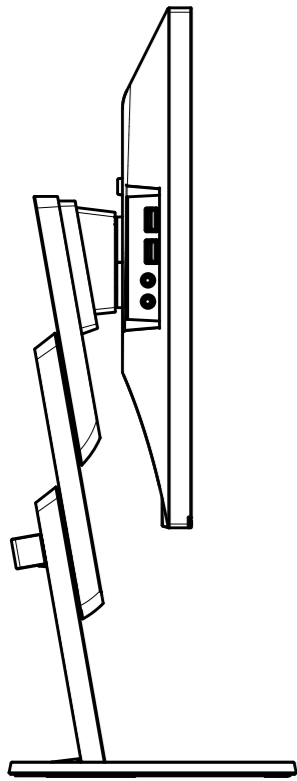
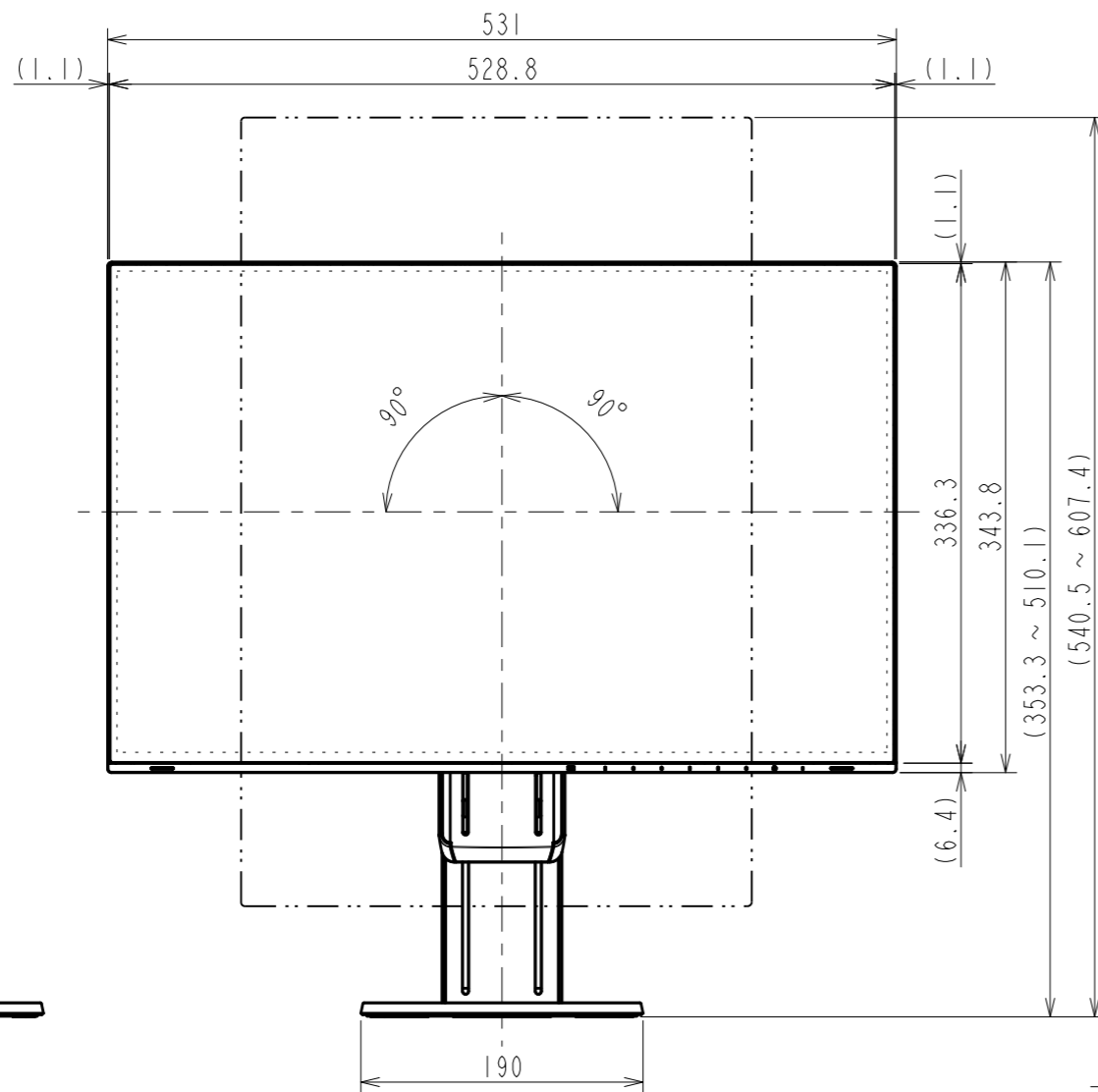
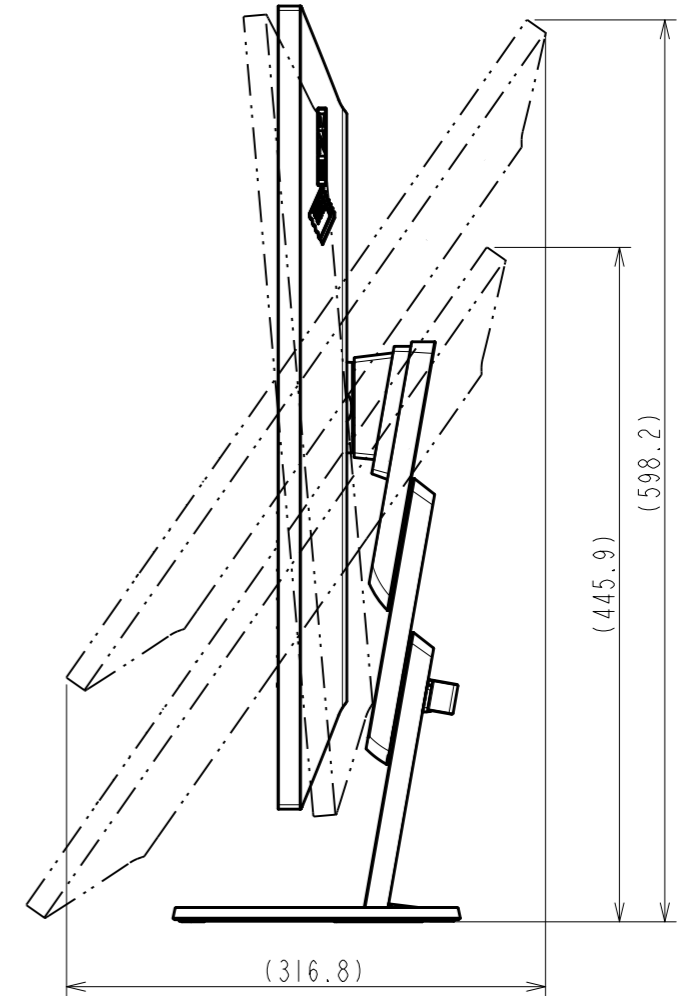
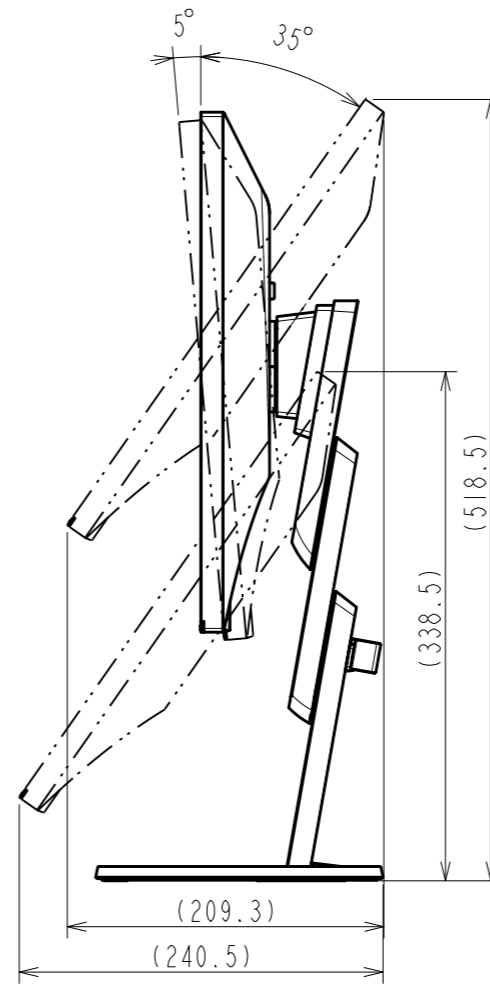
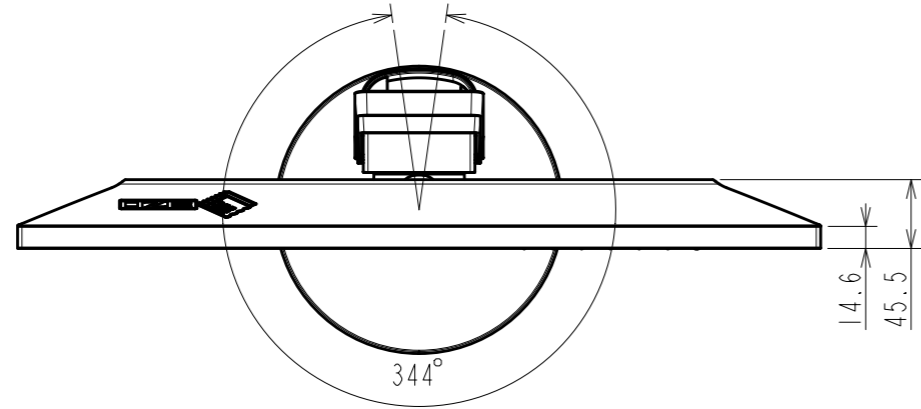

OUTLINE DIMENSIONS

MODEL EV2457

UNIT mm

EIZO Corporation

