



Setup Manual

DuraVision[®] *DX0231-IP*

IP Decoding Box

Software Version 7.3

Important

Carefully read this Setup Manual and User's Manual (downloaded from the website) before use to use the monitor correctly. Please retain this manual for future reference.

- You can check the latest product information, including the Setup Manual, from our web site.
www.eizoglobal.com

This product has been adjusted specifically for use in the region to which it was originally shipped.
If operated outside this region, the product may not perform as stated in the specifications.

No part of this manual may be reproduced, stored in a retrieval system, or transmitted, in any form or by any means, electronic, mechanical, or otherwise, without the prior written permission of EIZO Corporation.

EIZO Corporation is under no obligation to hold any submitted material or information confidential unless prior arrangements are made pursuant to EIZO Corporation's receipt of said information. Although every effort has been made to ensure that this manual provides up-to-date information, please note that EIZO product specifications are subject to change without notice.

About This Product

About the Usage of This Product

- This device outputs images from a network camera to a monitor connected with an HDMI® cable. If using this product for the following kinds of applications, where an extremely high degree of reliability and safety is required, then measures should be in place to maintain safety while using this product:
 - Transportation equipment (ships, aircraft, trains, and automobiles)
 - Safety devices (disaster prevention systems, security control systems, etc.)
 - Life-critical devices (medical devices, such as life-support devices and operating room devices)
 - Nuclear energy control devices (Nuclear energy control systems, security control systems of nuclear facilities, etc.)
 - Major system communication devices (operation control systems of transportation systems, air traffic control systems, etc.)
- This product has been adjusted specifically for use in the region to which it was originally shipped. If the product is used outside the region, it may not operate as specified in the specifications.
- This product may not be covered by warranty for uses other than those described in this manual.
- The specifications outlined in this document apply only when using the AC adapter and signal cables specified by EIZO.
- Only use optional products manufactured or specified by us with this product.

About the Installation

- If you place this product on a lacquer-coated desk, the color may adhere to the bottom of the product due to the composition of the rubber. Please check before use.
- Dew condensation may form on the surface or interior of this product when it is brought into a cold room, when the temperature suddenly rises, or when it is moved from a cold room to a warm room. In that case, do not turn the product on. Instead wait until the dew condensation disappears, otherwise it may cause some damage to the product.
- Please place this product horizontally on a stable surface, such as a desk, with the flat side facing down.
By using the dedicated mounting bracket (sold separately), this product can be mounted and used on a monitor. The mounting bracket can be purchased on the EIZO website. www.eizoglobal.com
Refer to the mounting bracket instruction manual for installation directions when using mounting brackets.

Cybersecurity Warnings and Responsibilities

- Please take the following measures to protect products and information assets from cyberattacks.
 - Prevent unauthorized physical access to the product by third parties.
 - Manage passwords so that they are not leaked.
 - Use this product on a secure network such as one that is isolated from the internet, a network within a firewall, or a VPN (Virtual Private Network).
- The latest software will be available on our website. Please review the update details and update the software as necessary, under your own responsibility.
- This product can be configured to log in automatically when the product starts without the need to enter a username and password. When setting up auto login, the administrator is responsible to take measures to prevent unauthorized access.
- This product encrypts and holds personal information, such as user names and passwords, and uses it for device authentication. In order to prevent information from being leaked, ensure proper disposal methods, such as erasing or destroying data when discarding the product.
- This product is equipped with various security features to prevent malicious access. To improve the security of the product, use these features properly.
 - USB lock function
 - Remote control lock function
 - HTTPS functionality
 - Web interface disable function
 - IP address filter function
 - IEEE 802.1X functionality
 - LDAP function
- For details on each function, refer to the User's Manual.

Cleaning

- Periodic cleaning is recommended to keep the product looking new and to prolong its operation lifetime.
- Gently wipe off any dirt on the product with a small amount of water or a soft cloth dampened with a mild detergent diluted in water.

Attention

- Never use a thinner, benzene, wax, or abrasive cleaner as they may damage the product.
- Use of alcohol or other chemicals for disinfection may lead to cracks, changes in gloss, discoloration, fading, or deterioration of display image quality. Be careful of the following points when using the product.
 - Do not let chemicals come into direct contact with the product.
 - Do not use wet wipers that have been impregnated with chemical solution, as they may contain a lot of liquid.
 - Do not allow chemicals to enter gaps or the interior of the product.
- For more information on cleaning and disinfection, please refer to our web site.
How to check: Access www.eizoglobal.com and type "disinfect" in the site search box to search.

Disclaimer

- EIZO shall not be held responsible for any direct or indirect damages (including, but not limited to, loss of anticipated profits) arising from the use or malfunction of this product, or any other related issues.
 - Misuse or negligence by the customer
 - Disassembly, repair, or modification by the customer
 - Inability to display images due to any reason or cause, including product malfunction or defects
 - Combination with third-party equipment or devices
 - Occurrence of privacy violations or other issues related to the customer's surveillance images due to any reason
 - Loss of registered or recorded information due to any reason
- This product can display images monitored by a camera, but this product alone does not prevent crime, etc.

CONTENTS

About This Product	3
About the Usage of This Product	3
About the Installation.....	3
Cybersecurity Warnings and Responsibilities	4
Cleaning	5
Disclaimer	5
1 Introduction	8
1.1 Package Contents.....	8
1.2 Controls and Functions	9
1.3 System Configuration.....	11
2 Setup	14
2.1 What to Prepare	14
2.2 Setting Cameras	14
2.3 Installation	17
2.4 Connecting Devices	17
2.5 Turn on the Power and Display the Live Image Screen.....	18
2.6 Displaying the Setting Screen	21
2.7 Setting the Date and Time	23
2.8 Setting the IP Address	24
2.9 Configuring the Language.....	25
2.10 Registering a Camera Using Auto Discovery.....	26
2.11 Preparing the Remote Control	27
3 Other Settings	28
3.1 Updating Software.....	28
3.2 Registering a License.....	28
3.3 Save and Load Settings Data to Other Products	29
3.4 Registering a Camera Manually.....	30
3.5 Registering Still Images	38
4 Troubleshooting	39
4.1 Power Problems.....	39
4.2 Camera Registration Problems	40
4.3 Video Problems.....	41
4.4 Other Problems	44
4.5 Checking a Camera Connection with Ping.....	45
4.6 Checking for Duplicate IP Addresses.....	45
4.7 Checking the IP Address of a Computer.....	45

Appendix	46
Warning for Radio interference	46
For U.S.A, Canada Only	46
For Europe, Australia, New Zealand, etc Only.....	47
LIMITED WARRANTY	47

1 Introduction

This document explains the settings required to display camera (network camera) images on a monitor.

1.1 Package Contents

Check that all of the following items are included in the package. If any of these are missing or damaged, contact your dealer or local EIZO representative listed separately.

Note

- The User's Manual is not included with the product. Please download it from our web site using the steps below.
 1. Access www.eizoglobal.com.
 2. From the menu, select "Support" > "Manuals."
 3. In the "Enter model name" text box, enter "DX0231-IP," and then press the "Search" button.
 4. Click the icon for the User's Manual.
- It is recommended that the box and packing materials be stored so that they can be used to move or transport this product.

- DX0231-IP (product main unit)
- HDMI cable (HDMI - HDMI, 0.5 m): HH050HS x 1

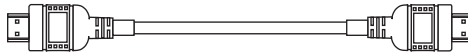

- PCSK-04 / PCSK-03 / PCSK-03R mounting screws (M3 x 6) x 2
Used when attaching the small terminal mounting adapter (PCSK-04 / PCSK-03 / PCSK-03R).
- Setup Manual (this document)
- PRECAUTIONS

1.2 Controls and Functions

1.2.1 Front

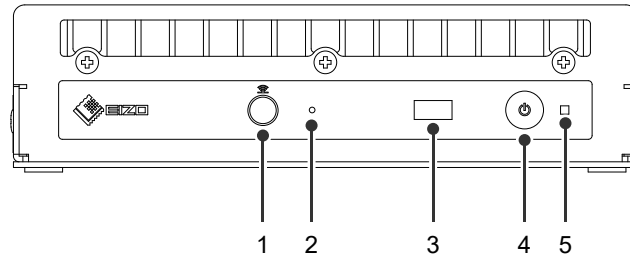

1. Connection terminal for remote control receiver unit	<p>If the remote control receiver unit cannot be used due to the installation location, use the remote control receiver cable to connect the receiver unit.</p> <p>When using the remote control receiver unit, the remote control receiver on the main unit is disabled.</p>
2. Reset button	<p>Press and hold for 10 seconds to reset all settings to their defaults, except for the system log, operation log, current time, time zone settings, license authentication information, and software version.</p>
3. Remote control receiver	<p>Receives signals from the remote control. For details on the receiver range, refer to the User's Manual.</p>
4.  button	<p>Turns the power on or off.</p>
5. Power indicator	<p>Displays the operating status of the product.</p> <p>Blue: Normal operation mode</p> <p>Flashing blue: Starting up</p> <p>Red: Power off</p> <p>Off: Main power is off</p>

1.2.2 Back

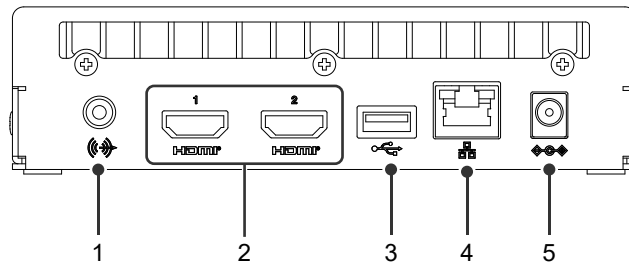

1. Stereo mini jack	This terminal emits the beep sound of the product main unit or audio from a network camera. Connects a commercially available stereo mini jack cable.	
2. HDMI 1 / HDMI 2	HDMI signal output connector. Connects to monitors that support HDMI® signal.	
3. USB downstream port	Connects a USB mouse, USB keyboard, or joystick.	
4. LAN port		Connects the network cable. Supplies power when connected to a network hub that supports PoE+. a) Active LED Off: No data communication Flashing orange: Data communication in progress b) Link LED Off: Network connection not established Green: Network connection established
5. DC input	Connects the AC adapter (sold separately).	

1.3 System Configuration

This product is used by connecting to a network.

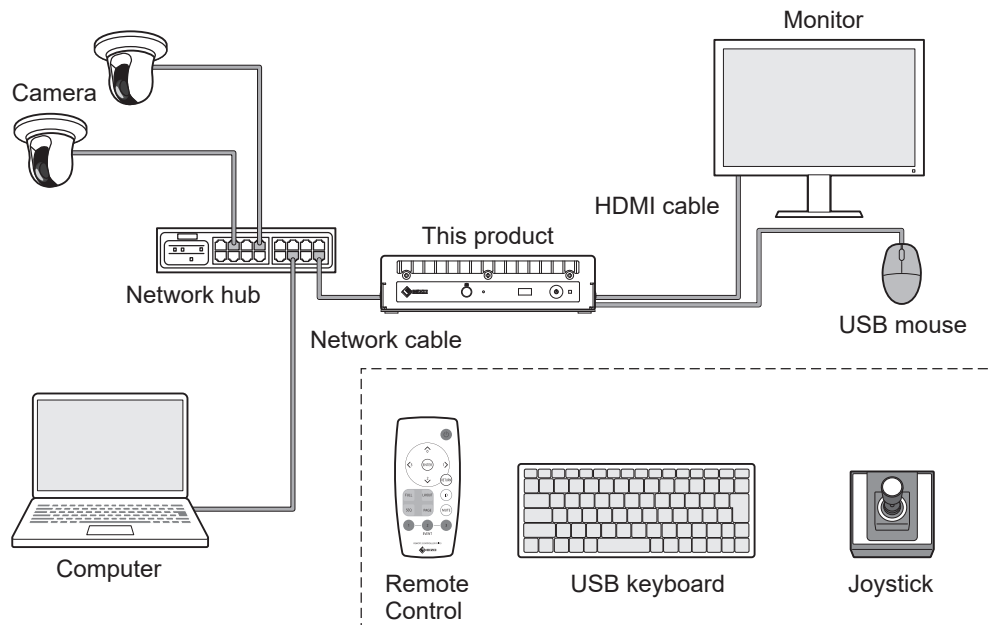

Note

IP addresses

- Since an IP address corresponds to an address on the network, each device must be set with a unique IP address (refer to [2.8 Setting the IP Address](#) [▶ 24]). If an IP address that overlaps with another device is set, communication will not work properly.

IP address: 192.168.0.10
Subnet mask: 255.255.255.0
Gateway: Blank

IP Address: 192.168.0.11
Subnet mask: 255.255.255.0
Gateway: Blank

IP Address: 192.168.0.2
Subnet mask: 255.255.255.0
Gateway: Blank

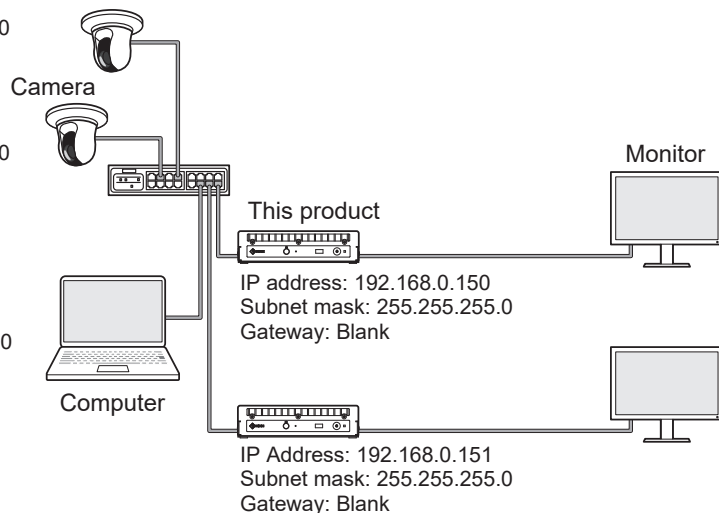

- If your network environment does not include a gateway (default gateway), you do not need to set the "Gateway" address.
- The default IP address of this product is "192.168.0.150." When installing multiple units, set unique IP addresses (refer to [4.6 Checking for Duplicate IP Addresses](#) [▶ 45]).

1.3.1 Camera (Network camera)

Cameras compliant with ONVIF® Profile S, Axis cameras, or Panasonic/i-PRO cameras

Attention
Camera compatibility <ul style="list-style-type: none">• In addition to displaying video, this product supports PTZ control and setting changes of cameras. However, not all functions may be available due to reasons such as the required API not being provided. For functions that are not available from this product or do not work as expected, please operate them directly on the camera.• If you need to control the PTZ settings of the camera from this product, please refer to the compatibility information of verified cameras. www.eizoglobal.com/support/db/products/model/DX0231-IP

1.3.2 Network hub

1000BASE-T / 100BASE-TX compatible network hub

When choosing a network hub, check the following:

- This product supports PoE+. By connecting to a PoE+ compatible network hub, this product can receive power through the network cable.
- If your network hub does not support PoE+, you will need to use an AC adapter (sold separately) to supply power to this product.
- When supplying power to the camera through a network cable, use a PoE-compatible network hub.

Attention
<ul style="list-style-type: none"> • This product supports only the PoE+ 2-Event Classification method. If your network hub does not support the 2-Event Classification method, supply power from an AC adapter (sold separately).

1.3.3 Network cable

Category 5e or higher straight cable

1.3.4 USB mouse

Used to control the live screen and setting screen.

Attention
<ul style="list-style-type: none"> • Only the live image screen can be controlled with the remote control.

1.3.5 Computer

Used to configure the product and cameras. After configuring, it can be removed from the network.

The following settings are available only if you are using a computer.

- Entering characters other than alphanumeric characters and symbols in the camera name
- Updating software
- Registering a license
- Saving/loading system information
- Saving logs
- Registering still images

If your computer does not have a LAN port, consider using a USB LAN adapter.

1.3.6 Video display monitor

Connect to the product with an HDMI cable to display camera images. Use a monitor that supports HDMI and can display the output resolution of this product. When connecting two monitors, prepare monitors with the same resolution. For information on the output resolution, refer to the User's Manual.

2 Setup

2.1 What to Prepare

Prepare a USB mouse and computer.

If you do not have an Internet connection at your work location, please have the following files on your computer in advance.

File	Where to get it
Set of user manuals <ul style="list-style-type: none"> • Setup Manual (this document) • User's Manual 	Please download the necessary files from the EIZO web page. www.eizoglobal.com/support/db/products/model/DX0231-IP
Latest version of system software	
License file	Additional features are available with the purchase of a license. For details on features, refer to the User's Manual. For details on purchasing a license, contact your dealer or local EIZO representative.

2.2 Setting Cameras

The camera must be configured in advance.

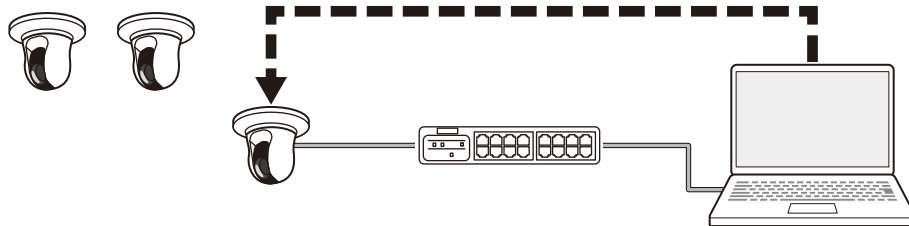

Refer to the User's Manual of the camera and perform the following settings.

2.2.1 Username and Password

Set a password of up to 32 characters using alphanumeric characters and symbols for a user with administrative privileges.

2.2.2 Date and Time

Select a time zone and set the correct date and time.

2.2.3 IP Address

Set an IP address that does not overlap with another device.

2.2.4 Stream

Set the stream to match the decoding performance of this product.

- Check if the stream is enabled.
- When using the "Panasonic/i-PRO" protocol, it connects to stream 2 by default.

Note

Camera stream

Typically, cameras support multiple streams and can transmit video at different resolutions and frame rates simultaneously.

The diagram shows a camera on the left. Two arrows originate from the camera, representing Stream 1 and Stream 2. Stream 1 is directed to a 'Video recorder' device. Stream 2 is split, with one arrow pointing to a device labeled 'This product' which is connected to a monitor, and another arrow pointing to a second identical device also connected to a monitor.

Stream 1

- Compression format: H.265
- Resolution: 1920 x 1080
- Frame rate: 30 Hz
- Bit rate: 4096 kbps

Stream 2

- Compression format: H.264
- Resolution: 1280 x 720
- Frame rate: 20 Hz
- Bit rate: 4096 kbps

- By separating stream 1 for recording and stream 2 for live image viewing, you can prevent changes in stream settings from affecting other devices.
- When registering a camera with "Panasonic/i-PRO" protocol, it connects to stream 2 by default.
- The stream to connect to can be changed by manual registration (refer to [3.4 Registering a Camera Manually](#) [▶ 30]).

Video compression format

Select the video compression format according to the "Protocol" used for camera registration.

- "ONVIF"
H.264 or MJPEG (when "Media Type" is "Media1"), or H.265 or H.264 (when "Media Type" is "Media2"^{*1}).
- "AXIS®"
H.265 or H.264
- "Panasonic/i-PRO"
H.265 or H.264

*1 The camera must comply with both ONVIF Profile S and ONVIF Profile T.

Note
<ul style="list-style-type: none"> • For the latest operating status for H.265, refer to the camera compatibility information on the EIZO website.

Bit Rate

Set a value to 8192 kbps or less. (4096 kbps recommended)

Resolution / Frame Rate

Set the "Resolution" and "Frame Rate" according to the number of cameras to be simultaneously displayed on the live image screen.

H.265 / H.264 (when "Bit Rate" is set to "4096 kbps")

Resolution of the video display monitor is 1920 x 1080, 60 Hz

1 Screen Layout	3840 x 2160 / 30 fps, 1920 x 1080 / 60 fps, 1280 x 720 / 60 fps
4 Screens Layout	3840 x 2160 / 20 fps, 1920 x 1080 / 60 fps, 1280 x 720 / 60 fps
9 Screens Layout	1920 x 1080 / 30 fps, 1280 x 720 / 50 fps, 640 x 480 / 60 fps
12 Screens Layout	1920 x 1080 / 20 fps, 1280 x 720 / 40 fps, 640 x 480 / 60 fps
16 Screens Layout	1920 x 1080 / 20 fps, 1280 x 720 / 40 fps, 640 x 480 / 60 fps
32 Screens Layout	1280 x 720 / 15 fps, 640 x 480 / 30 fps

The resolution of the video display monitor is 3840 x 2160, 60 Hz

1 Screen Layout	3840 x 2160 / 30 fps, 1920 x 1080 / 30 fps, 1280 x 720 / 30 fps
4 Screens Layout	3840 x 2160 / 20 fps, 1920 x 1080 / 30 fps, 1280 x 720 / 30 fps
9 Screens Layout	1920 x 1080 / 25 fps, 1280 x 720 / 30 fps, 640 x 480 / 30 fps
12 Screens Layout	1920 x 1080 / 20 fps, 1280 x 720 / 25 fps, 640 x 480 / 30 fps
16 Screens Layout	1920 x 1080 / 20 fps, 1280 x 720 / 25 fps, 640 x 480 / 30 fps
32 Screens Layout	1280 x 720 / 15 fps, 640 x 480 / 20 fps

MJPEG

640 x 480 / 30 fps

Attention
<ul style="list-style-type: none"> • The values above are provided for reference purposes. • If the stream exceeds the display capabilities of this product, the frame rate of the camera footage will be forcibly reduced. Reduce the resolution and/or bit rate.

2.3 Installation

Place this product on a stable surface, such as a desk, or install it using the dedicated mounting bracket (sold separately).

To protect the product and information assets from cyber attacks, take measures under your responsibility to prevent third parties from physically accessing the product.

The possible installation orientations are as follows.

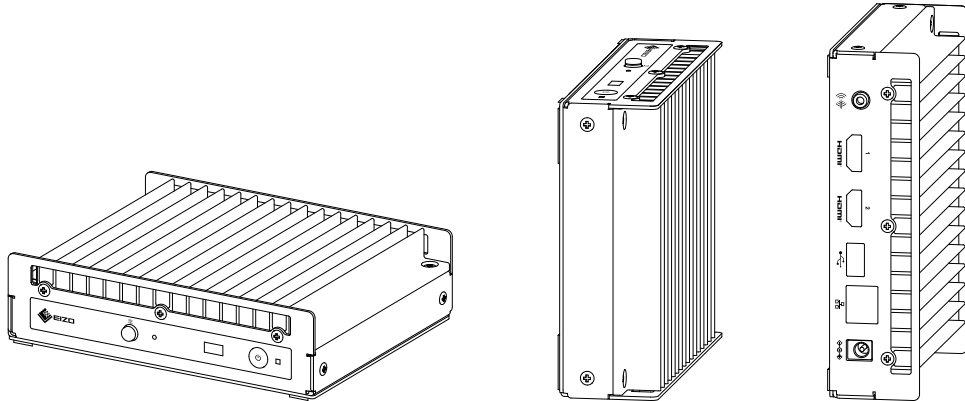

2.4 Connecting Devices

Note

- This product supports PoE+. If the network hub supports PoE+, it is operated by supplying power from the network hub, so there is no need to connect an AC adapter.
- If your network hub does not support PoE+, use an AC adapter (sold separately). Follow the steps below to complete the connection.
 1. Connect the power cord to the AC adapter.
 2. Connect the output terminal of the AC adapter to the DC input terminal of the product (insert it firmly all the way in).
 3. Connect the power plug to the power outlet.
- When the AC adapter is used while connected to a network hub that supports PoE+ compatible, power is supplied from the AC adapter.

1. Connect this product and the cameras to a network hub with network cables.

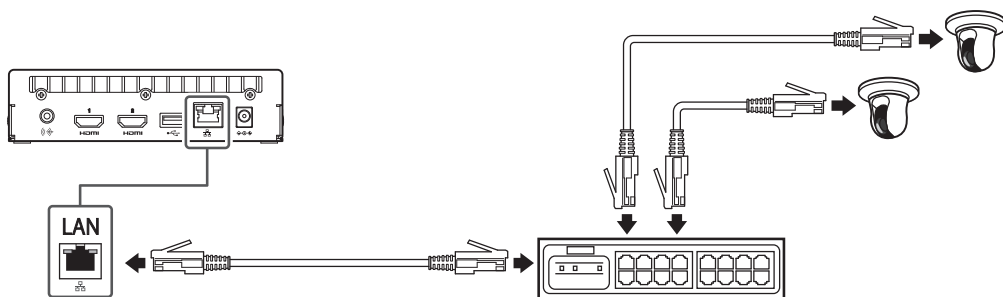

2. Connect this product and a video display monitor with an HDMI cable.

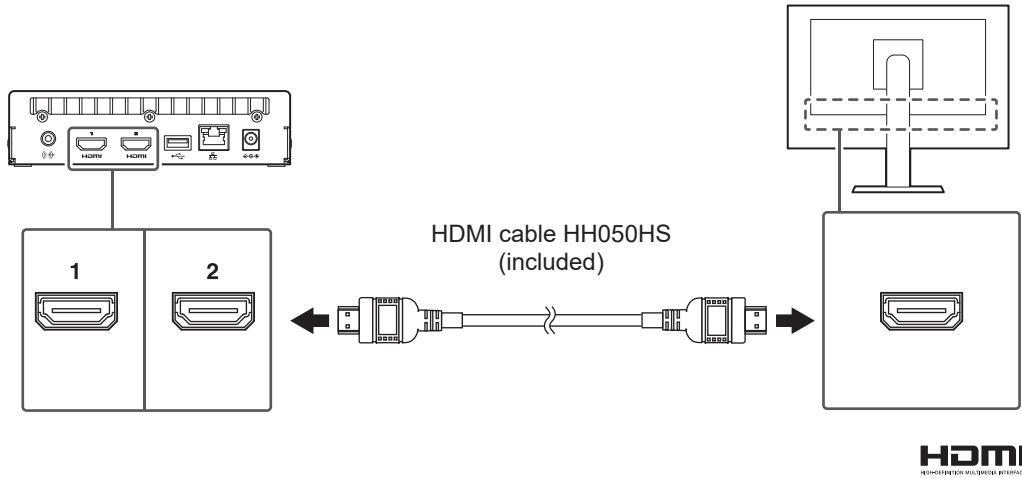

3. Connect the USB mouse to the USB downstream port.

Note

- Connecting to a device with USB hub function enables operation with multiple USB devices.

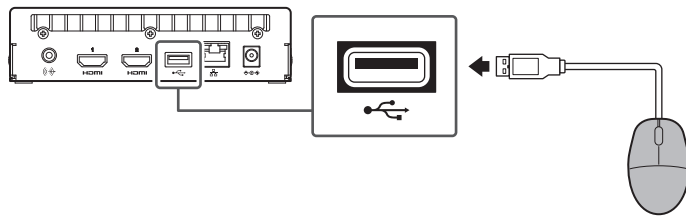

2.5 Turn on the Power and Display the Live Image Screen

1. Press the power button (⏻) on the front of the product.
While preparing to start, the power indicator blinks blue. It takes about 1 minutes for the device to start up.

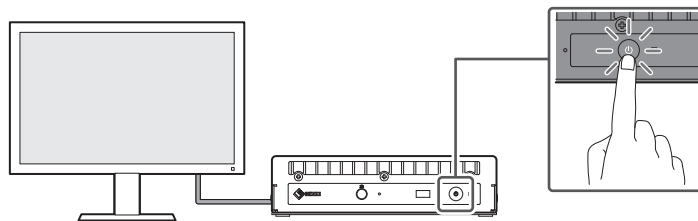

When it starts up, the power indicator turns blue and the screen is displayed. If the initial user registration is complete, the live screen is displayed.

2. When this product is started for the first time, the initial user registration screen is displayed. Set each item.
 - "Language" ([Language \[▶ 20\]](#))
 - "Keyboard Layout" ([Keyboard Layout \[▶ 20\]](#))
 - "User Level"
The user level cannot be selected when registering for the first time (fixed to "ADMIN").
 - "Username" ([Username \[▶ 20\]](#))
 - "Password" ([Password \[▶ 21\]](#))
 - "Confirm Password"
For confirmation, re-enter the same password.

DuraVision

Initial User Registration

Language English

Keyboard Layout English(US)

Apply

User Level ADMIN

Username

Your username must satisfy the following conditions:

- 1-16 characters
- Contain alphanumeric characters only
- May not contain the following characters: # & : " < > \

Password

Confirm Password

Your password must satisfy the following conditions:

- 8-16 characters
- At least one upper case and one lower case letter
- At least one number
- Contain no \ characters

Apply

Note

- Initial user registration can also be performed from the web console (refer to [When Using the Web Console \[▶ 22\]](#)).

3. Click "Apply."

- Click "OK" in the confirmation dialog box.
After restarting, the live screen is displayed.

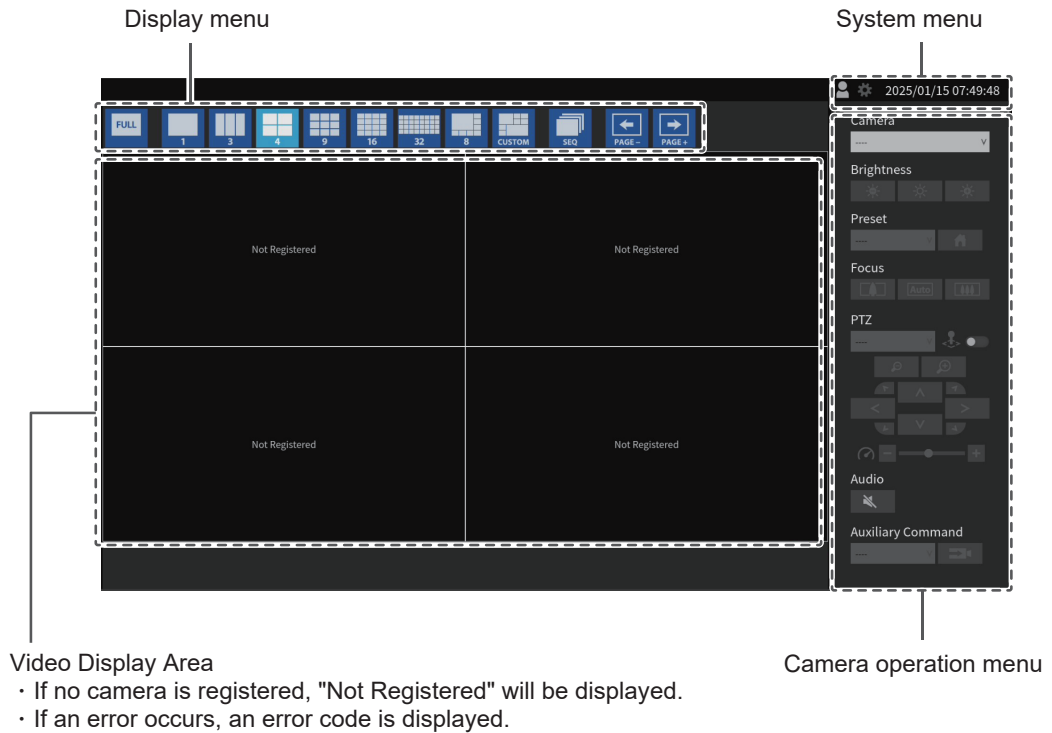

Note

- To turn off the power, press the power button (⏻) on the front of the product.
- You can also turn the power on/off with the power button (⏻) on the remote control.

Language

Settings: "日本語" / "English" / "Deutsch"

Select the language.

Keyboard Layout

Settings: "Japanese" / "English(US)" / "English(UK)" / "German"

Select the keyboard layout.

Username

Enter the username. Set the username so that it meets the following conditions.

- At least 1 character, 16 characters or less
- Alphanumeric characters only
- At least 1 number
- Does not contain the characters # &: "<>\

The following username cannot be set.

- "." / ".." / "auto-login"

Password

Enter the password. Set a password that is difficult for a third party to guess.

- 8 to 16 characters
- At least one uppercase and lowercase English letter
- At least one number
- Does not contain the character \

2.6 Displaying the Setting Screen

The setting screen can be operated using the monitor console (screen displayed on the monitor) or the web console (screen displayed on the browser).



To display the setting screen, it is necessary to log in as a user with a user level of "ADMIN."

2.6.1 When Using the Monitor Console

Use a mouse to perform operations. The setting screen cannot be operated using the remote control.

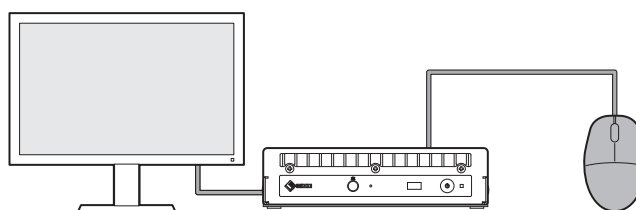
Clicking an item that requires characters to be input will display a software keyboard.



1. On the live image screen, click the login icon ().
2. Enter a username and a password.
3. Click "Login."
The setting icon () can then be selected.
4. Click the setting icon ().

2.6.2 When Using the Web Console

Perform operations from a computer connected to the network.

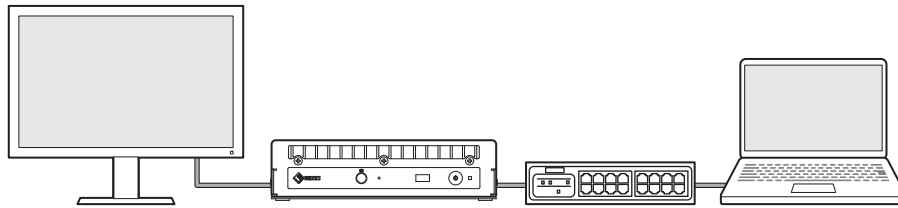

Note

- For information on computer network settings, refer to [4.7 Checking the IP Address of a Computer \[▶ 45\]](#).
- It is recommended to use Microsoft Edge version 79 or later.
- Since communication via HTTP is not encrypted, there is a risk that data may be intercepted by a third party. To ensure secure communication, it is recommended to use HTTPS.
- When accessing via https:// during the initial startup, a warning may appear in your browser due to the use of a self-signed certificate. This is normal behavior. If a warning appears, click "Advanced Settings" or "More Information" and select "Access this site (not secure)." After logging in, register "CA-Signed Certificate" and the warning will no longer be displayed.

1. Launch the browser.
2. Enter the following address to access the site.
Address: http://<IP address of this product> or https://<IP address of this product>
In the default settings, the IP address is http://192.168.0.150/ or https://192.168.0.150/
If you cannot display the web console, refer to [4.4 Other Problems \[▶ 44\]](#).
3. Enter a username and a password.

- Click "OK."
The setting screen appears.

Note

- If you cannot log in, try the following address.
<http://<IP address of product>/index.html> or <https://<IP address of product>/index.html>

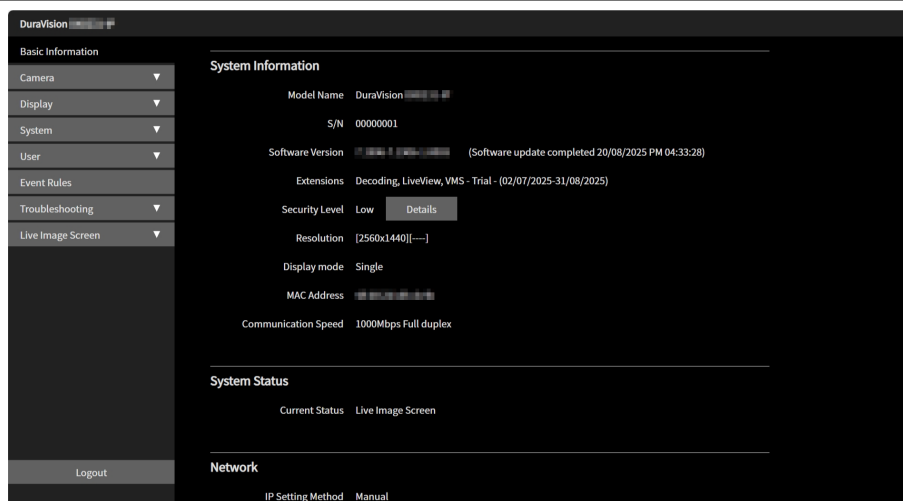

On the monitor console, the "Logout" menu at the bottom left of the screen changes to the "Return" menu.

2.7 Setting the Date and Time

Setting the correct date and time in the system will prevent problems communicating with cameras.

- Select "System" > "Date and Time."
- Set each item.
 - "Current Time" ([Current Time \[▶ 23\]](#))
 - "Date/Time Display Settings" ([Date/time display settings \[▶ 24\]](#))
 - "Time Zone Settings" ([Time Zone Settings \[▶ 24\]](#))
 - "Clock Settings" ([Clock Settings \[▶ 24\]](#))
- Click "Apply."

2.7.1 Current Time

Current Time

The current date and time of the product are displayed.

Current Time of PC

It is displayed when using the web console.

When "Sync with PC" is clicked, the current date and time of the computer is set on this product.

2.7.2 Date/time display settings

Date Format

Settings: "yyyy/mm/dd" / "Mmm/dd/yyyy" / "dd/Mmm/yyyy" / "mm/dd/yyyy" / "dd/mm/yyyy" / "No Date Display"

Select the date display format.

Time Format

Settings: "24h" / "12h"

Select the time display format.

2.7.3 Time Zone Settings

Time Zone

Select the time zone.

2.7.4 Clock Settings

Date and Time

Set the current time.

2.8 Setting the IP Address

1. Select "System" > "Network."
2. Set each item.
 - "IP Setting Method" ([IP Setting Method \[▶ 24\]](#))
 - "IP Address" ([IP Address \[▶ 24\]](#))
 - "Subnet Mask" ([Subnet Mask \[▶ 25\]](#))
 - "Gateway" ([Gateway \[▶ 25\]](#))
 - "Hostname" ([Hostname \[▶ 25\]](#))
3. Click "Apply."

2.8.1 Network

IP Setting Method

Settings: "DHCP" / "Manual"

Select the IP address setting method.

Note
<ul style="list-style-type: none">• If you have a DHCP server, select "DHCP" and the IP address will be set automatically. Since the configured IP address cannot be viewed on the web console, check it on the monitor console.

IP Address

Settings: "0.0.0.1" – "255.255.255.254"

Set an IP address that does not overlap with another device.

Note

- The default IP address is "192.168.0.150." When installing multiple units of this product, set unique IP addresses.
For information on how to check for duplicates, refer to [4.6 Checking for Duplicate IP Addresses \[▶ 45\]](#).

Subnet Mask

Settings: "0.0.0.1" to "255.255.255.254"

Set the subnet mask.

Gateway

Settings: "0.0.0.1" to "255.255.255.254"

Set the default gateway.

If your network environment does not have a gateway, you do not need to set "Gateway."
Leave either as default setting or blank.

Hostname

Settings: Alphanumeric characters and hyphens (up to 63 characters)

If "IP Setting Method" is set to "DHCP," enter the host name to be registered in the DHCP server. The default setting is "Product name - MAC address." Automatic registration to DNS depends on the DHCP/DNS server settings.

2.9 Configuring the Language

1. Select "System" > "Language."
2. Set each item.
 - "Language" ([Language \[▶ 25\]](#))
 - "Keyboard Layout" ([Keyboard Layout \[▶ 25\]](#))
3. Click "Apply."

Language

Settings: "日本語" / "English" / "Deutsch"

Select the language.

Keyboard Layout

Settings: "Japanese" / "English(US)" / "English(UK)" / "German"

Select the keyboard layout.

2.10 Registering a Camera Using Auto Discovery

Cameras connected to the network can be automatically detected and registered.

Attention

- The following cameras and video encoders must be registered manually (refer to [3.4 Registering a Camera Manually \[▶ 30\]](#)).
 - Cameras that cannot be discovered automatically
 - Cameras on different subnets cannot be discovered automatically.
 - Some cameras can be set to deny auto discovery or allow auto discovery only for a certain period of time after the camera is turned on.
 - Fisheye/panoramic cameras with multiple video streams
 - Video encoder with multiple cameras connected

1. Select "Camera" > "Camera Registration."
2. Click "Camera Auto Discovery."
3. Set each item.
 - "Protocol" ([Protocol \[▶ 26\]](#))
 - "User Name" ([User Name \[▶ 26\]](#))
 - "Password" ([Password \[▶ 26\]](#))
4. Click "OK."
A list of detected cameras is displayed.
Whether a camera can be automatically detected depends on the camera and network.
Cameras that do not appear in the list must be registered manually.
5. Check the camera to register, and select "Add."
6. Click "Apply."
7. Click "OK" in the confirmation dialog box.
If a communication error is displayed, refer to [4.2 Camera Registration Problems \[▶ 40\]](#).
If the video is not displayed correctly, refer to [4.3 Video Problems \[▶ 41\]](#).

Protocol

Select the protocol to control the camera.

- "ONVIF"^{*1}
ONVIF Profile S compatible cameras
- "AXIS"
Axis cameras (VAPIX®)
- "Panasonic/i-PRO"
Panasonic/i-Pro cameras

*1 When "Protocol" is set to "ONVIF," the "Media Type" will be "Media1."

User Name

Enter the username of the camera. A user with administrative privileges is required.

Password

Enter the password for the camera.

2.11 Preparing the Remote Control

Note

- The remote control is a separately sold optional accessory.

How to attach and remove batteries

1. Turn the bottom of the remote control upwards and slide it in the direction of the arrow to remove the cover.
2. Insert batteries (AAA size x 2) according to the "+" (positive)" and "-" (negative)" poles indicated on the remote control.
3. Place the cover back on.

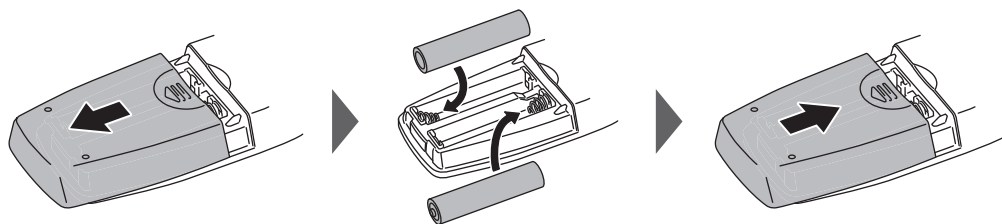

*To remove the battery, remove it in Step 2.

3 Other Settings

3.1 Updating Software

Use the web console to perform operations.

You can perform a software version upgrade. Please download the version update file from the EIZO website (www.eizoglobal.com) in advance. For stable operation of the system, it is recommended to use the latest software. It is not possible to revert to an older version.

1. Select "System" > "Maintenance."
2. Click "Software Update" > "File" > "Browse."
3. Select the software file (extension: duraup4).
4. Click "Start."
5. Click "OK" in the confirmation dialog box.

The process starts.

During processing, the power indicator flashes red. Do not turn off the power. It takes approximately 5 minutes to update the software.

3.2 Registering a License

Perform this operation on the web console.

1. Select "System" > "Maintenance."
2. Click "License Activation" > "Extensions" > "Activate."
3. Click "Browse" and select the license file (extension: duralic).
4. Click "OK."

The process starts.

Close the browser and wait 2 minutes before accessing again.

Attention

- | |
|--|
| <ul style="list-style-type: none">• Selecting "Deactivate" will remove all additional registered licenses. |
|--|

3.3 Save and Load Settings Data to Other Products

This operation is performed in the web console.

You can save the settings data from a configured product and load them onto other products on the network. This helps reduce the effort of setting up each device individually.

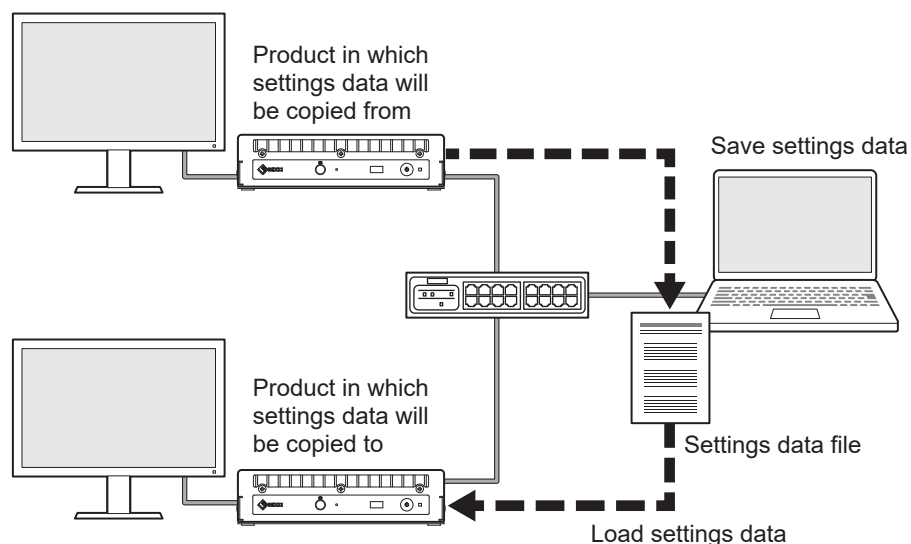

Attention

- Please set a unique IP address for each product in advance. If IP addresses are duplicated, the web console cannot be displayed.

1. Access the web console of the product whose settings you want to copy.
Address: <http://<IP address of the source product>/> or <https://<IP address of the source product>/>
2. Select "System" > "Maintenance."
3. Click "Save" under "Settings Data Migration" > "Settings Data."
4. In the "Settings Data Migration" dialog box, enter a Password to set for the file.
5. Click "OK."
6. Specify where to save the file.
The settings data file will be saved.
7. Access the web console of the product to which you want to copy the settings.
Address: <http://<IP address of the destination product>/> or <https://<IP address of the destination product>/>
8. Select "System" > "Maintenance."
9. Click "Load" under "Settings Data Migration" > "Settings Data."
10. Select the settings data file and enter the password you set.
Do not check "Include network settings."
11. Click "OK."
12. Click "OK" in the confirmation dialog box.
The process will begin.
Close the browser and access it again after 2 minutes.

3.4 Registering a Camera Manually

The following cameras and video encoders must be registered manually.

- Cameras that cannot be detected automatically
- Fisheye/panoramic cameras multiple streams of different images
 - Register multiple fisheye/panoramic cameras with the same IP address and specify the stream to be displayed.
- Video encoder with multiple cameras connected
 - Register multiple video encoders with the same IP address and specify the streams to be displayed. For Panasonic/i-PRO video encoders that support multiple channels, specify the camera to be displayed in "Channel."

Attention

- The camera must be connected to the network even when registering it manually.

1. Select "Camera" > "Camera Registration."
2. Check the position number to register, and click Edit ()
3. Set each item.
The displayed items vary depending on the protocol. First, select "Protocol" (refer to [Protocol \[▶ 30\]](#)).
 - Common items ([Common items \[▶ 30\]](#))
 - "ONVIF" ([ONVIF \[▶ 31\]](#))
 - "AXIS" ([AXIS \[▶ 32\]](#))
 - "Panasonic/i-PRO" ([Panasonic/i-PRO \[▶ 33\]](#))
 - "EIZO Streaming Gateway" ([EIZO Streaming Gateway \[▶ 34\]](#))
 - "DirectUri" ([DirectUri \[▶ 36\]](#))
 - "SRT" ([SRT \[▶ 37\]](#))
 - "Still Image File" ([Still Image File \[▶ 37\]](#))
 - "Qognify" ([Qognify \[▶ 37\]](#))
4. Click "OK."
5. Click "Apply."
The camera image is displayed on the live screen.
If a communication error is displayed, refer to [4.2 Camera Registration Problems \[▶ 40\]](#).
If the video is not displayed correctly, refer to [4.3 Video Problems \[▶ 41\]](#).

3.4.1 Common items

Protocol

Settings: "ONVIF" / "AXIS" / "Panasonic/i-PRO" / "EIZO Streaming Gateway" / "DirectUri" / "SRT"^{*1} / "Still Image File" / "Qognify"^{*1}

^{*1} This can be selected when the corresponding extended functionality license are registered for this product.

Select the protocol to control the camera.

- "ONVIF"
ONVIF Profile S compatible cameras
- "AXIS"
Axis cameras (VAPIX)
- "Panasonic/i-PRO"
Panasonic/i-PRO cameras

- "EIZO Streaming Gateway"
Select if you want to connect to a product that has the streaming gateway feature enabled.
- "DirectUri"
Select when connecting to an RTSP stream URI (URI starting with rtsp://) or an RTP stream URI (URI starting with rtp://).
- "SRT"
Select to connect to an SRT stream URI.
- "Still Image File"
Select this option to select an uploaded still image.
- "Qognify"
Select this when linking with a Qognify VMS.

Camera Name

Settings: Any character (up to 100 characters)

Enter the camera name. To enter characters other than alphanumeric characters and symbols, use the web console. If you want to insert a line break in the camera name, enter \n at the position where you want the line to break.

Enter "IP Address," "Port," "Username," "Password" and click "Obtain Camera Name" to get the camera name from the camera.

3.4.2 ONVIF

IP Address

Settings: "0.0.0.1" – "255.255.255.254"

Enter the IP address of the camera.

Click "Ping" to perform a connection test on the camera.

Port

Settings: "1" – "65535"

Enter the port number of the camera.

The typical port number is "80" ("443" if SSL is enabled).

SSL

Configures secure settings.

The camera must have a server certificate set up.

Since communication via HTTP is not encrypted, there is a risk that data may be intercepted by a third party. To ensure secure communication, it is recommended to use SSL (HTTPS).

Certificate Validation

Performs certificate validation during SSL communication.

The camera's root certificate must be registered in "Certificate" > "Root Certificate."

Username

Settings: Alphanumeric characters and symbols (up to 32 characters)

Enter the username of the camera. A user with administrative privileges is required.

Password

Settings: Alphanumeric characters and symbols (up to 32 characters)

Enter the password for the camera.

Media Type

Settings: "Media1" / "Media2"

Select the media type.

- "Media1" (default setting)
Select to connect to H.264 and MJPEG streams.
- "Media2"
Select to connect to H.265 and H.264 streams. The camera must comply with both ONVIF Profile S and ONVIF Profile T.

Media Profile

Settings: Depends on the camera

Specify the stream to connect to by selecting a media profile. Click "Obtain Profile" to get a list of profiles from the camera.

Transmission Mode

Settings: "Unicast" / "Multicast"

Select the transmission mode

Comm. Method

Settings: "RTP over UDP" / "RTP over RTSP"

Select the communication method for camera video images.

3.4.3 AXIS

IP Address

Settings: "0.0.0.1" – "255.255.255.254"

Enter the IP address of the camera.

Click "Ping" to perform a connection test on the camera.

Port

Settings: "1" – "65535"

Enter the port number of the camera.

The typical port number is "80" ("443" if SSL is enabled).

SSL

Configures secure settings.

The camera must have a server certificate set up.

Since communication via HTTP is not encrypted, there is a risk that data may be intercepted by a third party. To ensure secure communication, it is recommended to use SSL (HTTPS).

Certificate Validation

Performs certificate validation during SSL communication.

The camera's root certificate must be registered in "Certificate" > "Root Certificate."

Username

Settings: Alphanumeric characters and symbols (up to 32 characters)

Enter the username of the camera. A user with administrative privileges is required.

Password

Settings: Alphanumeric characters and symbols (up to 32 characters)

Enter the password for the camera.

Video Stream

Settings: Depends on the camera

Select the view area for the stream. Click "Obtain Stream" to get a list of view areas from the camera.

The view area is used to stream a portion of the entire image. Refer to the User's Manual of the camera for details.

Stream Profile

Settings: Depends on the camera

Specify the stream to connect to by selecting a stream profile. Click "Obtain Profile" to get a list of profiles from the camera.

If no profile is registered on the camera, this product will automatically register the "EIZO_Profile" profile to the camera.

Transmission Mode

Settings: "Unicast" / "Multicast"

Select the transmission mode

Comm. Method

Settings: "RTP over UDP" / "RTP over RTSP"

Select the communication method for camera video images.

3.4.4 Panasonic/i-PRO

Unicast/Multicast cannot be set from this product. Change the transmission mode on the camera.

IP Address

Settings: "0.0.0.1" – "255.255.255.254"

Enter the IP address of the camera.

Click "Ping" to perform a connection test on the camera.

Port

Settings: "1" – "65535"

Enter the port number of the camera.

The typical port number is "80" ("443" if SSL is enabled).

SSL

Configures secure settings.

The camera must have a server certificate set up.

Since communication via HTTP is not encrypted, there is a risk that data may be intercepted by a third party. To ensure secure communication, it is recommended to use SSL (HTTPS).

Certificate Validation

Performs certificate validation during SSL communication.

The camera's root certificate must be registered in "Certificate" > "Root Certificate."

Username

Settings: Alphanumeric characters and symbols (up to 32 characters)

Enter the username of the camera. A user with administrative privileges is required.

Password

Settings: Alphanumeric characters and symbols (up to 32 characters)

Enter the password for the camera.

Stream

Settings: "1" / "2" / "3" / "4"

Select the stream to connect to.

Channel

Settings: "1" / "2" / "3" / "4"

Select a stream channel.

Comm. Method

Settings: "RTP over UDP" / "RTP over RTSP"

Select the communication method for camera video images.

3.4.5 EIZO Streaming Gateway

IP Address

Settings: "0.0.0.1" – "255.255.255.254"

Enter the IP address of the Streaming Gateway.

Click "Ping" to perform a connection test.

Port

Settings: "1" – "65535"

Enter the port number of the Streaming Gateway.

If "Protocol" is set to "EIZO Streaming Gateway," enter the access port of the Streaming Gateway web server (default: "80," or "443" if SSL is enabled).

SSL

Ensures secure communication.

A server certificate must be configured on the Streaming Gateway.

Since communication via HTTP is not encrypted, there is a risk that data may be intercepted by a third party. To ensure secure communication, it is recommended to use SSL (HTTPS).

Certificate Validation

Performs certificate validation during SSL communication.

The root certificate for the Streaming Gateway must be registered in "Certificate" > "Root Certificate."

Username

Settings: Alphanumerics and symbols (up to 32 characters)

Enter the user name of the Streaming Gateway. A user with administrative privileges is required.

Password

Settings: Alphanumerics and symbols (up to 32 characters)

Enter the password of the Streaming Gateway.

Stream List

Specify the stream to connect to. Click the "Obtain Stream List" button to get a list of streams from the transmitter.

If "Streaming Gateway" > "Streaming settings" > "Protocol" of the source is set to "RTP," you cannot select that stream.

RTSP Username

Settings: Alphanumeric characters and symbols (up to 79 characters)

The RTSP username is automatically set. It can also be changed.

RTSP Password

Settings: Alphanumeric characters and symbols (up to 79 characters)

The RTSP password is automatically set. It can also be changed.

RTSP Comm. Method

Settings: "RTP over RTSP"

Select the communication method for camera video images.

SRT Latency

Settings: "20 ms" to "8000 ms"

Set the latency.

This can be selected when the corresponding extended functionality license are registered for this product.

SRT Passphrase

Settings: Alphanumeric characters and symbols (up to 79 characters)

Set the passphrase.

This can be selected when the corresponding extended functionality license are registered for this product.

3.4.6 DirectUri

Note

- To receive an MPEG2-TS stream with RTP, select "Comm. Method" or "RTP over UDP" in "RTP over RTSP."
- To receive an MPEG2-TS stream over UDP, check the following points.
 - Specify the port number (1024 to 65535) that receives the stream in "Port" and select "MPEG2-TS over UDP" in "Comm. Method."
 - You should make stream transmission settings for this product from the transmitter in advance.
 - For non-multicast communication, leave the IP address blank.

IP Address

Settings: "0.0.0.1" – "255.255.255.254"

Enter the IP address of the camera.

Click "Ping" to perform a connection test on the camera.

Port

Settings: "1" – "65535"

Enter the port number of the camera.

Typical port numbers are "554" when "Protocol" is "DirectUri," and "URI" is an RTSP stream URI.

Username

Settings: Alphanumeric characters and symbols (up to 32 characters)

Enter the username of the camera. A user with administrative privileges is required.

Password

Settings: Alphanumeric characters and symbols (up to 32 characters)

Enter the password for the camera.

URI

Settings: Alphanumeric characters (up to 1023 characters)

Enter an RTSP stream URI (starting with rtsp://, http://, or https://) or an RTP stream URI (starting with rtp://).

Transmission Mode

Settings: "Unicast" / "Multicast" / "Source-Specific Multicast"

Select the transmission mode.

Comm. Method

Settings: "RTP over UDP" / "RTP over RTSP" / "MPEG2-TS over UDP" / "RTSP over HTTP" / "RTSP over HTTPS"

Select the communication method for camera video images.

3.4.7 SRT

IP Address

Settings: "0.0.0.1" – "255.255.255.254"

Enter the IP address of the camera.

Click "Ping" to perform a connection test on the camera.

Port

Settings: "1" – "65535"

Enter the port number of the camera.

Latency

Settings: "20 ms" to "8000 ms"

Set the latency.

Passphrase

Settings: Alphanumeric characters and symbols (up to 79 characters)

Set the passphrase.

3.4.8 Still Image File

Content number

Settings: "1" – "4"

Select an image uploaded using the "Still Image Registration" function ([3.5 Registering Still Images ▶ 38](#)). A preview of the selected image is displayed.

3.4.9 Qognify

IP Address

Settings: "0.0.0.1" – "255.255.255.254"

Enter the IP address of the camera.

Click "Ping" to perform a connection test on the camera.

Port

Settings: "1" – "65535"

Enter the port number of the camera.

If "Protocol" is set to "Qognify," enter the server access port of the Qognify VMS (default: 62000).

Username

Settings: Alphanumeric characters and symbols (up to 32 characters)

Enter the username of the camera. A user with administrative privileges is required.

Password

Settings: Alphanumeric characters and symbols (up to 32 characters)

Enter the password for the camera.

Camera List

Click "Obtain Camera Name" to retrieve a list of camera names.

Comm. Method

Settings: "RTP over RTSP"

Select the communication method for camera video images.

3.5 Registering Still Images

[Only for the web console]

Upload images to the product. If you specify an image uploaded during camera registration, it can be displayed in the camera display area (see [3.4 Registering a Camera Manually](#) [▶ 30]).

1. Select "Camera" > "Still Image Registration."
2. Click "Upload."
3. Select the image to register, then click "Open."

4 Troubleshooting

4.1 Power Problems

4.1.1 The live image screen is not displayed

- The power indicator is not turned on
 - Is the power correctly connected? Connect the AC adapter or network hub that supports PoE+.
 - Are the power cords of the AC adapter and network hub properly connected?
- The power indicator is red
 - Press the POWER button (⏻) on the front of the product.
- The power indicator is flashing red
 - Connected to a PoE-compatible network hub but power is insufficient. Connect to a network that supports PoE+ or to an AC adapter (sold separately).
- The power indicator is blue
 - Check whether the product is properly connected to the monitor with an HDMI cable. Connect to HDMI 1 instead of HDMI 2.
 - Pull out the HDMI cable and connect it again.
 - Check whether the input signal of the monitor is set to HDMI. Check if the monitor settings are correct. For details, refer to the User's Manual of the monitor.

4.1.2 After a power outage, the camera image is no longer displayed

- If the error code "E**-**" is displayed, refer to [4.3 Video Problems \[▶ 41\]](#).
- Request the camera to stream again.
 - For the monitor console, click the setting icon (⚙️) with the mouse to display the settings screen, then select "Return" to return to the live image screen.
 - For the web console, select "Live Image Screen" > "Stream Refresh" > "Stream Refresh" > "Execute."
- Depending on the camera, the settings may be reset when the power is turned off and on again. Check if the camera settings are correct (refer to [2.2 Setting Cameras \[▶ 14\]](#)).

4.1.3 Restarts all of a sudden

- When the temperature inside the product rises high, this product may restart repeatedly. Check the temperature around this product. The internal temperature may rise high when the product is used in a narrow or poorly ventilated place or when the product is used with an object placed on top of it.

4.2 Camera Registration Problems

4.2.1 Camera cannot be detected automatically

- Whether a camera can be automatically detected depends on the camera and network. Cameras that do not appear in the list must be registered manually (refer to [3.4 Registering a Camera Manually \[▶ 30\]](#)).

4.2.2 Communication error appears when clicking "Apply" in auto discovery

Auto discovery also detects cameras that do not have an IP address, username, or password set. To register, the camera must be configured correctly.

- Make sure you can connect to the camera (refer to [4.5 Checking a Camera Connection with Ping \[▶ 45\]](#)).
- Check that a password is set for the camera (refer to [2.2 Setting Cameras \[▶ 14\]](#)).
- Make sure the user you entered has administrative privileges.
- If different user names and passwords are set for each camera, check the position number where the error is displayed, click the edit icon () and re-enter the username and password.

4.2.3 Communication error appears when clicking "Apply" in manual registration

- Make sure you can connect to the camera (refer to [4.5 Checking a Camera Connection with Ping \[▶ 45\]](#)).
- Check that a password is set for the camera (refer to [2.2 Setting Cameras \[▶ 14\]](#)).
- Make sure the user account you entered has administrative privileges.
- Make sure the IP address, port (typically "80," or "443" if SSL is enabled), username and password of the camera are correct.
- Depending on the camera, there are settings to disable the ONVIF profile, and settings for the relevant port, user, and password. Check if there are settings related to the ONVIF profile on the camera.
- Cameras not verified by EIZO may not be compatible with this product. Consider registering cameras with the "DirectUri" protocol. For the RTSP stream URI (URI starting with rtsp://) to be entered as the URI, refer to the User's Manual of the camera or contact the camera manufacturer. When connected via the "DirectUri" protocol, video can be displayed, but PTZ control and setting changes cannot be performed on the camera.

4.3 Video Problems

4.3.1 Error message "E**-**" is displayed

If the problem is not resolved, refer to [Correct image is not displayed \[▶ 43\]](#).

- E01-**
 - Check if the camera streaming settings are correct (refer to [2.2 Setting Cameras \[▶ 14\]](#)).
 - There is a possibility that the camera is not working properly due to the high load. Disconnect other network devices accessing the camera or reduce the resolution or bit rate of the camera.
 - If the camera is connected to a different subnet, check that TCP and UDP communication is permitted on the router connecting the subnets.
- E02-**

E02-02

 - Authentication has failed. Make sure the username and password of the camera are correct.

E02-03

 - Streaming has stopped. If the error is caused by the camera being turned off or disconnection of the camera, the error changes to E02-04.
 - If the camera is connected to a different subnet, check that TCP and UDP communication is permitted on the router connecting the subnets.

E02-04

 - Check if the power of the camera is on.
 - Make sure you can connect to the camera (refer to [4.5 Checking a Camera Connection with Ping \[▶ 45\]](#)).
 - Make sure there are no duplicate IP addresses for the product or camera (refer to [4.6 Checking for Duplicate IP Addresses \[▶ 45\]](#)).
If the IP addresses of the products are duplicated, the camera image will be sent to only one device.

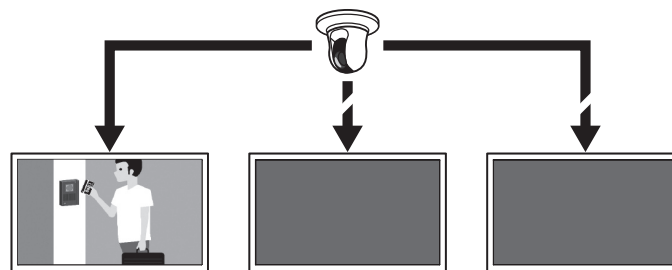

Products with duplicate IP addresses

E02-07

- If "Certificate Validation" is enabled, make sure that the certificate expiration date and other information are correct.

E03-**

- The network bandwidth may be under pressure or the display performance of this product may be exceeded. Reduce the resolution and/or bit rate of the camera (refer to [2.2 Setting Cameras \[▶ 14\]](#)).

E04-**

- A resolution which is incompatible with this product may be set. Try changing the resolution of the camera (refer to [2.2 Setting Cameras \[▶ 14\]](#)).

E05-**

- The stream format from the camera may be different from that of this product. Check the settings of the camera and this product and then restart this product.

E06-**

- The multicast setting value may not be set correctly. Check the settings of the camera.

E07-**

- The network may not be connected, such as the network cable is not connected to this product. Check the network connection.

E08-**

- There is no available license to use the camera protocol. Check the license.

4.3.2 Moving object slows down or speeds up

If the problem is not resolved, refer to [Correct image is not displayed \[▶ 43\]](#).

- The stream may contain B frames.
 - Select "Live Image Screen" > "Advanced" and turn "B frame decode buffer" to "Enable." If the problem does not resolve, uncheck the box.
 - Select "Live Image Screen" > "Advanced" and turn "Skip non-reference frames" to "Enable." If the problem does not resolve, uncheck the box.
- If B frames are the cause, disabling B frames on the camera can also resolve the problem.
- Frames may not be output according to the timestamp from the camera. Select "Live Image Screen" > "Advanced" and turn "Sync timestamp" to "Enable." If the problem does not resolve, uncheck the box.

4.3.3 Correct image is not displayed

Images are distorted

Displayed images are not smooth

Black images are displayed

Images are displayed or distorted at different times

- Select "Live Image Screen" > "Advanced" and turn "Network traffic condition" to "On." A circle indicating the communication status is displayed in the upper right corner of the image. If the circle is green, communication is normal.



If the circle is yellow or red, packets are not received successfully. There is a problem with the camera or network path.

- There is a possibility that the camera is not working properly due to the high load. Disconnect other network devices accessing the camera or reduce the resolution of bit rate of the camera.
- Make sure there are no problems with the router, hubs, or network cables in the network path.

If the circle is gray, the stream exceeds the indicated performance of this product.

- Reduce the resolution and/or bit rate of the camera.
- Make sure there are no duplicate IP addresses for the product or camera (refer to [4.6 Checking for Duplicate IP Addresses \[▶ 45\]](#)).
- Make sure the camera user entered has administrative privileges.
- Check if the camera streaming settings are correct (refer to [2.2 Setting Cameras \[▶ 14\]](#)).
- If the protocol is "ONVIF," "AXIS" or "Panasonic/i-PRO" and the transmission mode is "Unicast," select "RTP over RTSP" as the connection method. Since TCP is used for streaming, the problem may resolve with packet control.
- Check whether the used hubs and network cables are appropriate for handling the amount of information transferred. If the transmission mode is unicast, the amount of information transferred is (camera bit rate) x (number of connections).
- Select "Troubleshooting" > "Network Connection Status," and check the current communication bandwidth (sending, receiving).

4.4 Other Problems

4.4.1 Cannot log in

- Re-enter the username and password.
- Reset the account information using the Reset button and log in as the default setting account (refer to [1.2 Controls and Functions \[▶ 9\]](#)).

4.4.2 Cannot display the setting screen

- It is necessary to log in as a user with a user level of "ADMIN."
- A USB mouse is required to perform settings. Settings cannot be performed with the remote control.

4.4.3 The set date and time are not displayed correctly

- If the system is not connected to the power supply for one week or longer, the date and time will not be displayed correctly. In such a case, set the date and time again (refer to [2.7 Setting the Date and Time \[▶ 23\]](#)).

4.4.4 Unable to view web console in browser

- Make sure there are no duplicate IP addresses for the product (refer to [4.6 Checking for Duplicate IP Addresses \[▶ 45\]](#)).
- Check if the IP address of the computer is correct (refer to [4.7 Checking the IP Address of a Computer \[▶ 45\]](#)).

4.4.5 License registration fails

- Make sure the system is set to the correct date and time (refer to [2.7 Setting the Date and Time \[▶ 23\]](#)).
- Please send the error code, product name, serial number, product software version, and erroneous license file to your license dealer.

4.4.6 The mouse / keyboard does not work

- Connect the USB cable correctly.
- Pull out the USB cable and connect it again.
- Make sure that the USB lock function is not enabled (refer to "User's Manual" for details).

4.4.7 The camera display position cannot be changed

- "CAMERA CONTROL" or "ADMIN" users can operate the camera (refer to "User's Manual" for details).
- Display position of the camera cannot be changed during sequential display (refer to "User's Manual" for details).

4.4.8 No audio output

- Check whether the stereo mini jack cable is connected properly.
- Is the volume of the output device set to "0"?
- Check the settings of the camera.
 - Is the audio input configured correctly?
 - Is audio streaming enabled?
 - Have you selected an audio compression format that this product supports?

4.5 Checking a Camera Connection with Ping

To execute a Ping, perform one of the following.

- Click "Ping" in the "Camera Registration" edit screen.
- Select "Troubleshooting" > "Connection Confirmation," then select the camera and click "ping" > "Run."

If the camera cannot be connected, "Destination Host Unreachable" will be displayed. Make sure the camera is turned on and there are no problems with the router, hubs, or network cables in the network path.

- Example) Execution result

- If the camera can be connected

```
PING 192.168.0.27 (192.168.0.27) 56(84) bytes of data.
64 bytes from 192.168.0.27: icmp_seq=1 ttl=64 time=0.741 ms
64 bytes from 192.168.0.27: icmp_seq=2 ttl=64 time=0.771 ms
64 bytes from 192.168.0.27: icmp_seq=3 ttl=64 time=0.797 ms
```

- If the camera cannot be connected

```
PING 192.168.0.27 (192.168.0.27) 56(84) bytes of data.
From 192.168.0.150 icmp_seq=1 Destination Host Unreachable
From 192.168.0.150 icmp_seq=2 Destination Host Unreachable
From 192.168.0.150 icmp_seq=3 Destination Host Unreachable
```

4.6 Checking for Duplicate IP Addresses

a. Select "Troubleshooting" > "Network Connection Status" and click "Current Status." If the IP address of this product is duplicated with other devices, "Unicast reply from" will be displayed for the number of duplicated units. Set unique IP addresses.

- Example) Execution result

- If there are no duplicate IP addresses

```
ARPING 192.168.0.150 from 0.0.0.0 eth0
Sent 2 probes (2 broadcast(s))
Received 0 response(s)
```

- If there are duplicate IP addresses

```
ARPING 192.168.0.150 from 0.0.0.0 eth0
Unicast reply from 192.168.0.150 [00:00:00:00:00:00] *1
Sent 2 probes (2 broadcast(s))
Received 0 response(s)
```

*1 The MAC address of duplicate device is displayed.

4.7 Checking the IP Address of a Computer

For Windows computers, you can check and change the LAN port network settings by following the steps below.

1. Press Windows + R key.
2. Enter ncpa.cpl in the "Run" window and click "OK."
3. Select "Ethernet" from the list and double-click.
If there are multiple LAN ports, "Ethernet 2" and "Ethernet 3" are displayed.
4. Select "Internet Protocol Version 4 (TCP/IPv4)" and click "Properties."
5. Change the network settings and click "OK."

For setting details, contact the computer manufacturer.

Appendix

Warning for Radio interference

For U.S.A, Canada Only

FCC Supplier's Declaration of Conformity

We, the Responsible Party

Company: EIZO Inc.

Address: 5710 Warland Drive, Cypress, CA 90630

Phone: (562) 431-5011

declare that the product

Trade name: EIZO

Model: DuraVision DX0231-IP

is in conformity with Part 15 of the FCC Rules. Operation of this product is subject to the following two conditions: (1) this device may not cause harmful interference, and (2) this device must accept any interference received, including interference that may cause undesired operation.

WARNING!

This equipment has been tested and found to comply with the limits for a Class A digital device, pursuant to Part 15 of the FCC Rules. These limits are designed to provide reasonable protection against harmful interference when the equipment is operated in a commercial environment. This equipment generates, uses, and can radiate radio frequency energy and if not installed and used in accordance with the instruction manual, may cause harmful interference to radio communications. Operation of this equipment in a residential area is likely to cause harmful interference in which case the user will be required to correct the interference at his own expense.

Changes or modifications not expressly approved by the party responsible for compliance could void the user's authority to operate the equipment.

Note

Use the attached specified cable below or EIZO signal cable with this monitor so as to keep interference within the limits of a Class A digital device.

- AC Adapter
- Shielded Signal Cable (enclosed)

Canadian Notice

This Class A information technology equipment complies with Canadian ICES-003.

Cet équipement informatique de classe A est conforme à la norme NMB-003 du Canada.

For Europe, Australia, New Zealand, etc Only**Warning**

Operation of this equipment in a residential environment could cause radio interference.

Warnung

Der Betrieb dieses Geräts in einer Wohnumgebung könnte Funkstörungen verursachen.

Avertissement

L'utilisation de cet équipement dans une zone résidentielle pourrait provoquer des interférences radio.

LIMITED WARRANTY

EIZO Corporation (hereinafter referred to as "EIZO") and distributors authorized by EIZO (hereinafter referred to as the "Distributors") warrant, subject to and in accordance with the terms of this limited warranty (hereinafter referred to as the "Warranty"), to the original purchaser (hereinafter referred to as the "Original Purchaser") who purchased the product specified in this document (hereinafter referred to as the "Product") from EIZO or Distributors, that EIZO and Distributors shall, at their sole discretion, either repair or replace the Product at no charge if the Original Purchaser becomes aware within the Warranty Period (defined below) that the Product malfunctions or is damaged in the course of normal use of the Product in accordance with the description in the instruction manual of the Product (hereinafter referred to as the "User's Manual").

The period of this Warranty is two (2) years from the date of purchase of the Product (hereinafter referred to as the "Warranty Period").

EIZO and Distributors shall bear no liability or obligation with regard to the Product in relation to the Original Purchaser or any third parties other than as provided under this Warranty.

EIZO and Distributors will cease to hold or store any parts (excluding design parts) of the Product upon expiration of five (5) years after the production of the Product is discontinued.

In repairing the Product, EIZO and Distributors will use renewal parts which comply with our QC standards. If the unit cannot be repaired due to its condition or the stockout of a relevant part, EIZO and Distributors may offer the replacement by a product with equivalent performance instead of repairing it.

The Warranty is valid only in the countries or territories where the Distributors are located. The Warranty does not restrict any legal rights of the Original Purchaser.

Notwithstanding any other provision of this Warranty, EIZO and Distributors shall have no obligation under this Warranty whatsoever in any of the cases as set forth below:

1. Any defect of the Product caused by freight damage, modification, alteration, abuse, misuse, accident, incorrect installation, disaster, adherent dust, faulty maintenance and/or improper repair by third party other than EIZO and Distributors;
2. Any incompatibility of the Product due to possible technical innovations and/or regulations;
3. Any deterioration of the sensor, including measurement value of the sensor;
4. Any defect of the Product caused by external equipments;
5. Any defect of the Product caused by the use under environmental conditions other than EIZO and Distributors' estimation;
6. Any deterioration of the attachments of the Product (e.g. cables, User's Manual, CD-ROM, etc.);
7. Any deterioration of the consumables, and/or accessories of the Product (e.g. batteries, remote controller, touch pen, etc.);
8. Any deformation, discoloration, and/or warp of the exterior of the Product;

9. Any defect of the Product caused by placement in a location where it may be affected by strong vibrations or shocks;

10. Any deterioration or malfunction of the cooling fan caused by adherent dust.

To obtain service under the Warranty, the Original Purchaser must deliver the Product, freight prepaid, in its original package or other adequate package affording an equal degree of protection, assuming the risk of damage and/or loss in transit, to the local Distributor. The Original Purchaser must present proof of purchase of the Product and the date of such purchase when requesting services under the Warranty.

The Warranty Period for any replaced and/or repaired product under this Warranty shall expire at the end of the original Warranty Period.

EIZO OR DISTRIBUTORS ARE NOT RESPONSIBLE FOR ANY DAMAGE TO, OR LOSS OF, DATA OR OTHER INFORMATION STORED IN ANY MEDIA OR ANY PART OF ANY PRODUCT RETURNED TO EIZO OR DISTRIBUTORS FOR REPAIR.

EIZO AND DISTRIBUTORS MAKE NO FURTHER WARRANTIES, EXPRESSED OR IMPLIED, WITH RESPECT TO, INCLUDING, WITHOUT LIMITATION, THE PRODUCT AND ITS QUALITY, PERFORMANCE, MERCHANTABILITY OR FITNESS FOR ANY PARTICULAR USE.

IN NO EVENT SHALL EIZO OR DISTRIBUTORS BE LIABLE FOR ANY INCIDENTAL, INDIRECT, SPECIAL, CONSEQUENTIAL OR OTHER DAMAGE WHATSOEVER (INCLUDING, WITHOUT LIMITATION, DAMAGES FOR LOSS OF PROFIT, BUSINESS INTERRUPTION, LOSS OF BUSINESS INFORMATION, OR ANY OTHER PECUNIARY LOSS) ARISING OUT OF THE USE OR INABILITY TO USE THE PRODUCT OR IN ANY CONNECTION WITH THE PRODUCT, WHETHER BASED ON CONTRACT, TORT, NEGLIGENCE, STRICT LIABILITY OR OTHERWISE, EVEN IF EIZO OR DISTRIBUTORS HAVE BEEN ADVISED OF THE POSSIBILITY OF SUCH DAMAGES.

THIS EXCLUSION ALSO INCLUDES ANY LIABILITY WHICH MAY ARISE OUT OF THIRD PARTY CLAIMS AGAINST THE ORIGINAL PURCHASER. THE ESSENCE OF THIS PROVISION IS TO LIMIT THE POTENTIAL LIABILITY OF EIZO AND DISTRIBUTORS ARISING OUT OF THIS LIMITED WARRANTY AND/OR SALES.

