



User's Manual

EIZO IP Decoder Utility

Ver.1.0

Important

Please read this "User's Manual" carefully to familiarize yourself with safe and effective usage.

No part of this manual may be reproduced, stored in a retrieval system, or transmitted, in any form or by any means, electronic, mechanical, or otherwise, without the prior written permission of EIZO Corporation. EIZO Corporation is under no obligation to hold any submitted material or information confidential unless prior arrangements are made pursuant to EIZO Corporation's receipt of said information. Although every effort has been made to ensure that this manual provides up-to-date information, please note that EIZO product specifications are subject to change without notice.

CONTENTS

CONTENTS	3
About the EIZO IP Decoder Utility	4
IP Decoder Registration and Deletion	5
Register an IP Decoder.....	5
Confirming Registered IP Decoders	7
Deleting an IP Decoder.....	8
Exporting IP Decoder Information	10
Importing IP Decoder Information	11
Software Updates	13
License Activation	15
Diagnostic Reporting	17
EIZO IP Decoder Utility Settings	20
EIZO IP Decoder Utility Information	21
Error Codes	22
Appendix	23
Trademark	23

About the EIZO IP Decoder Utility

The EIZO IP Decoder Utility is a software designed to centrally manage multiple EIZO decoders (IP Decoding Box/IP Monitor).

The administrator can check lists of information about multiple IP decoders, or carry out bulk updates for IP decoders. In addition, the Diagnostic Reporting function makes it possible to create files that include information required for problem analysis through simple operations.

System Configuration

The system centrally manages information about multiple IP decoders by communicating with them via the network.

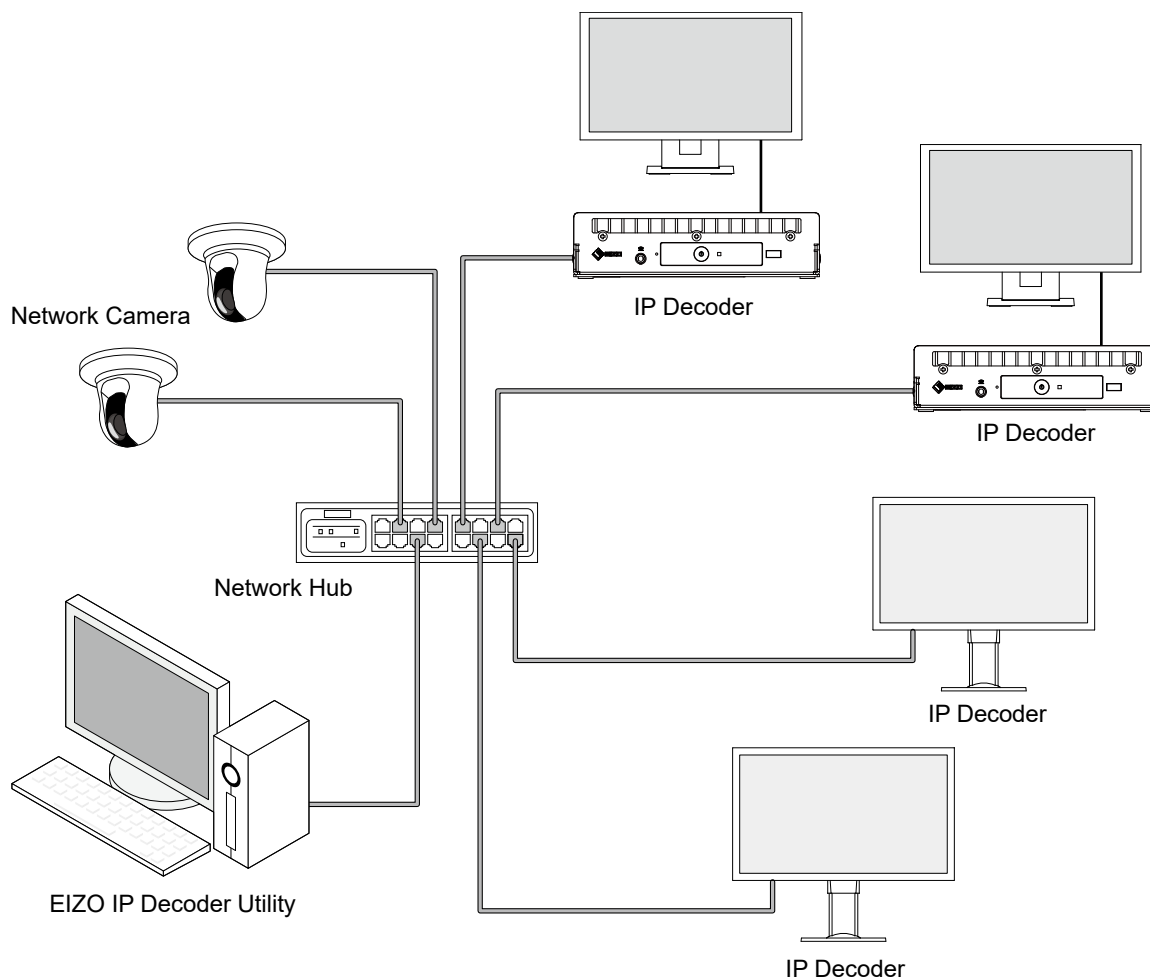

IP Decoder Registration and Deletion

Register an IP Decoder

Register the IP Decoder you administer. The following IP Decoders can be registered.

- FDF2711W-IP
- DX0211-IP

As the EIZO IP Decoder Utility does not store the registered information in its software, exiting the software means all registered IP Decoder information will be deleted. If you wish to continue using the same information the next time the software is launched, you need to use the "Export" and "Import" functions. (See ["Exporting IP Decoder Information" \(P.10\)](#) and ["Importing IP Decoder Information" \(P.11\)](#).)

1. Click "Register" on the main screen.

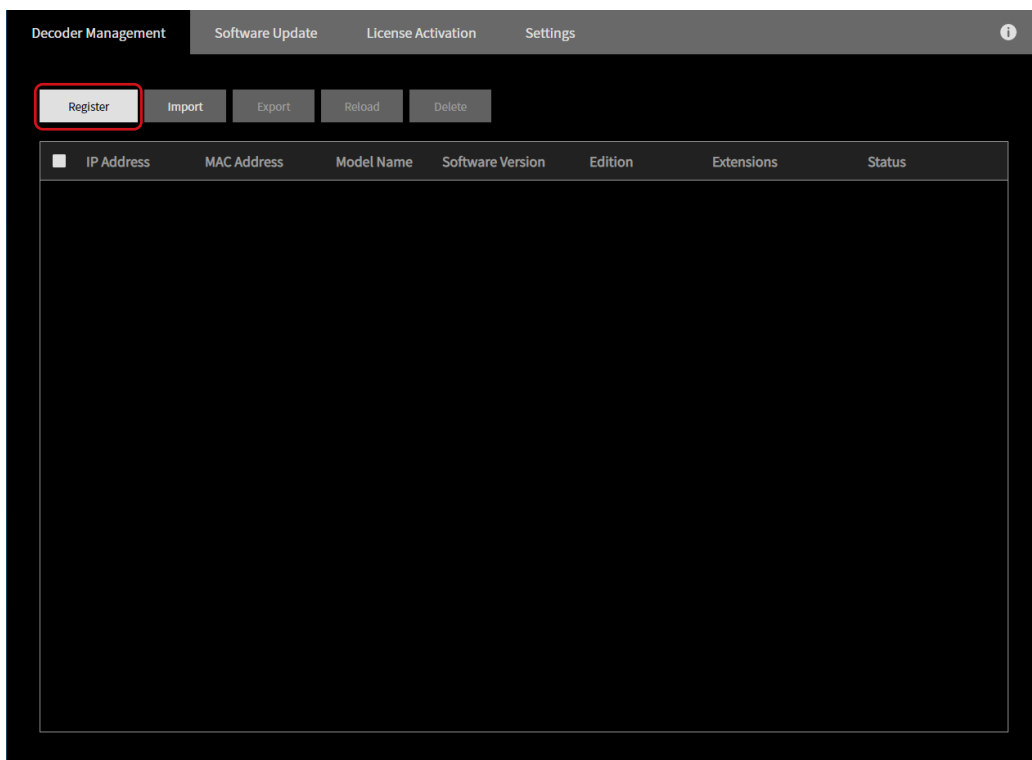

This displays the Manual Registration screen.

2. Set the IP Decoder information to register and click "OK".

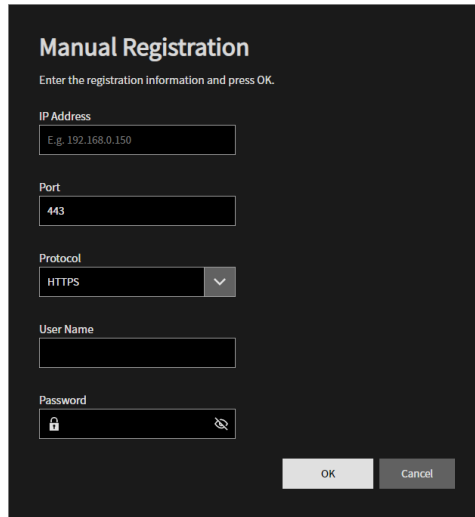

The image shows a 'Manual Registration' dialog box with a dark background. It contains the following fields: 'IP Address' with a text box containing 'E.g. 192.168.0.150', 'Port' with a text box containing '443', 'Protocol' with a dropdown menu showing 'HTTPS', 'User Name' with an empty text box, and 'Password' with a text box containing a lock icon and a clear icon. At the bottom right, there are 'OK' and 'Cancel' buttons.

Item	Description	Range
IP Address	Enter the IP address of the IP Decoder.	-
Port	Enter the port number of the IP Decoder.	0 to 65535
Protocol	Select the protocol to control the IP Decoder.	HTTPS / HTTP
User Name	Enter the user name set in the IP Decoder.	-
Password	Enter the password set in the IP Decoder.	-

Once registration has completed successfully, a message saying so is displayed.

3. Click "OK".

Confirming Registered IP Decoders

You can see the registered IP Decoder information in a list on the main screen.

- IP Address
Displays IP address.
- MAC Address
Displays MAC address.
- Model
Displays model name.
- Software Version
Displays software version.
- Edition
Displays edition. (Displayed if the software version is 5.2000 or later.)
- Extensions
Check marks signify valid extensions. (Displayed if the software version is 5.4000 or later.)
- Status
Confirms the status of communication with the IP Decoder every minute, and displays the results. Displays "Error" if normal communication is not possible. You can also click "Reload" to confirm the current status.

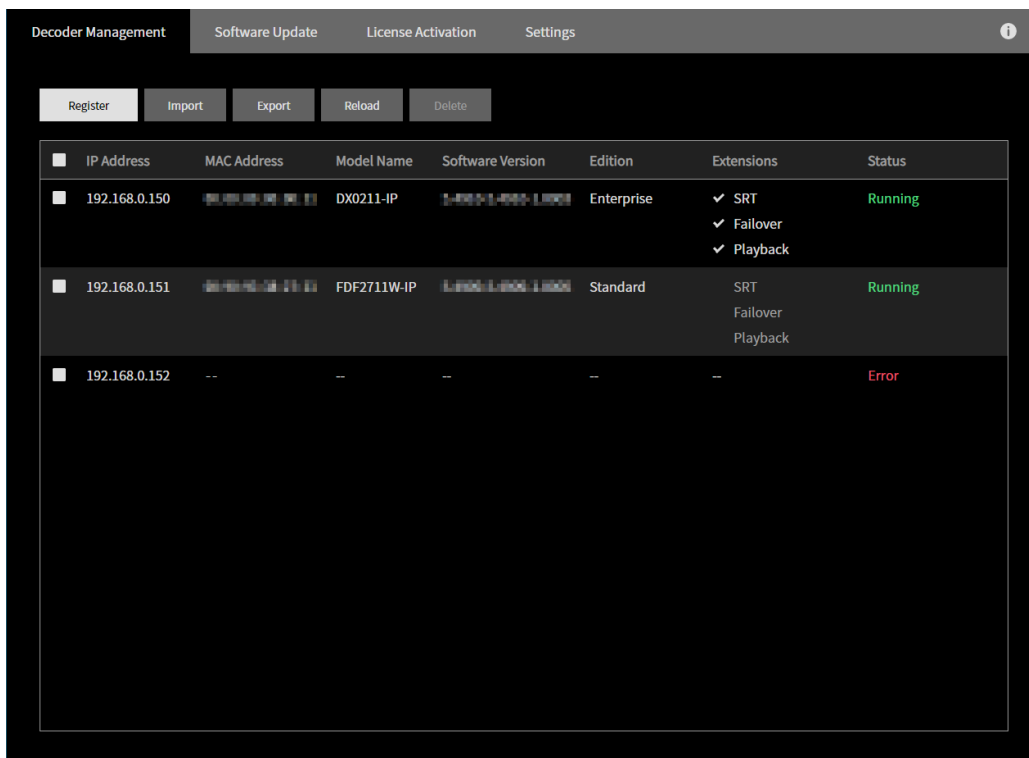

The screenshot shows the 'Decoder Management' interface with a table of registered IP decoders. The table has columns for IP Address, MAC Address, Model Name, Software Version, Edition, Extensions, and Status. There are three rows of data. The first row shows a decoder at IP 192.168.0.150 with model DX0211-IP, software version 5.4000-1.0000, Enterprise edition, and Running status. The second row shows a decoder at IP 192.168.0.151 with model FDF2711W-IP, software version 5.4000-1.0000, Standard edition, and Running status. The third row shows a decoder at IP 192.168.0.152 with dashes for all other fields and an Error status.

IP Address	MAC Address	Model Name	Software Version	Edition	Extensions	Status
192.168.0.150	08:00:27:00:00:01	DX0211-IP	5.4000-1.0000	Enterprise	✓ SRT ✓ Failover ✓ Playback	Running
192.168.0.151	08:00:27:00:00:02	FDF2711W-IP	5.4000-1.0000	Standard	SRT Failover Playback	Running
192.168.0.152	--	--	--	--	--	Error

Deleting an IP Decoder

Delete a registered IP Decoder. You can either delete multiple decoders at once, or one at a time.

Deleting multiple decoders

1. Select the IP Decoders to delete from the main screen. Check the topmost check box to select all IP Decoders in the list.
2. Click "Delete".

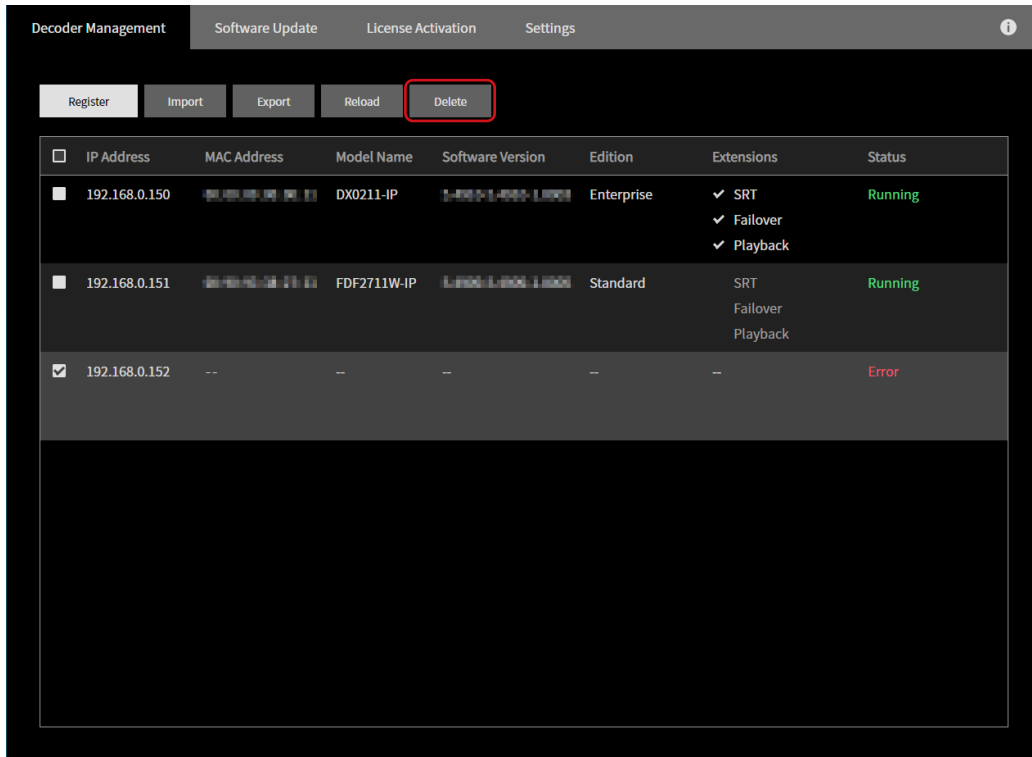

A confirmation message is displayed.

3. Click "OK".

Delete individual decoders

1. Move your mouse over the IP Decoder to delete on the main screen, and click the  mark.

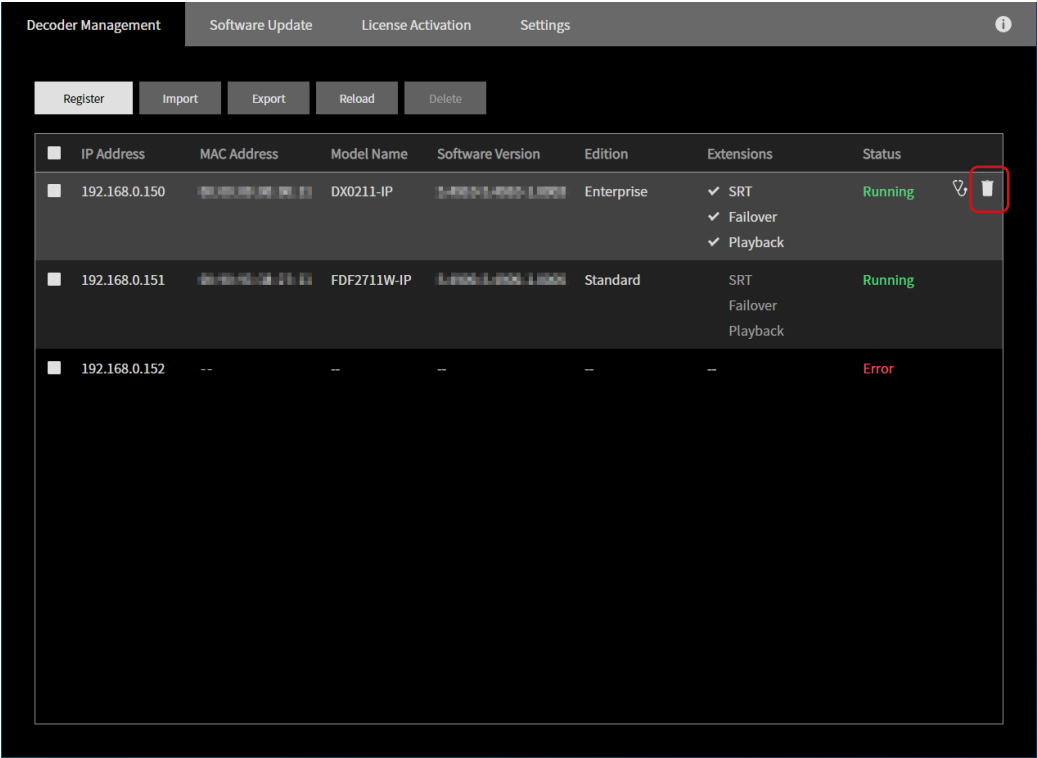

A confirmation message is displayed.

2. Click "OK".

Exporting IP Decoder Information

Save the information of all registered IP Decoders to a file. The file will include the following information about the IP Decoders.

- IP Address
- Port number
- Protocol
- User name
- Password

1. Click "Export".

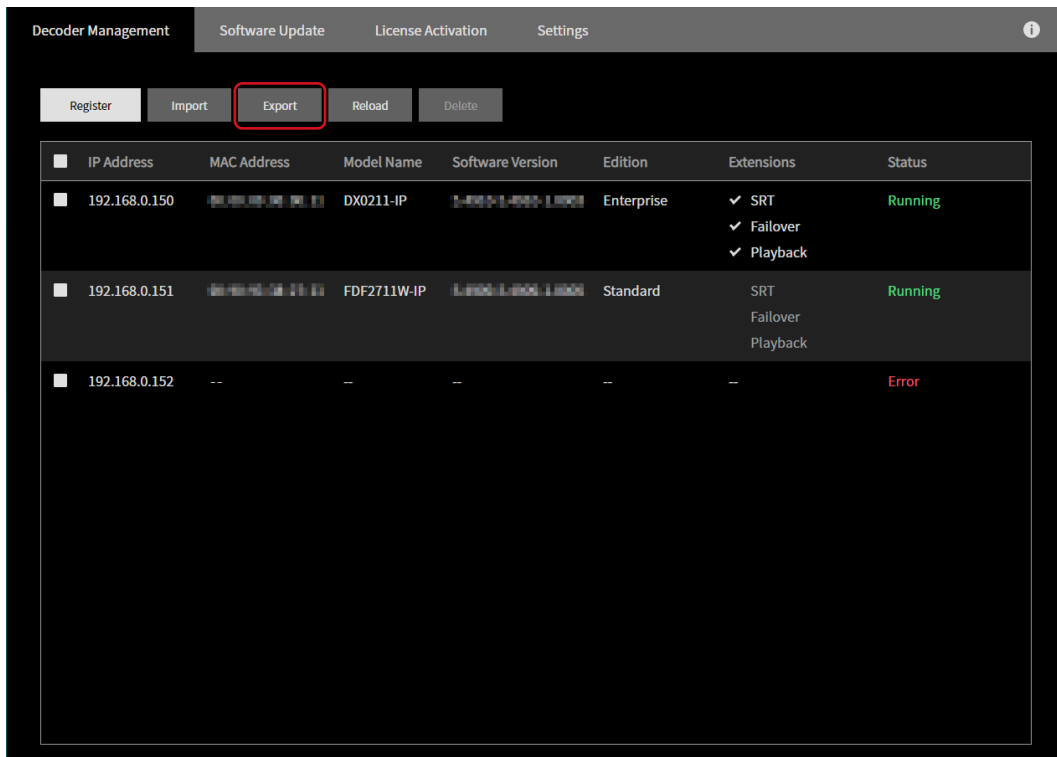

This displays the setting screen.

2. Click "Select".

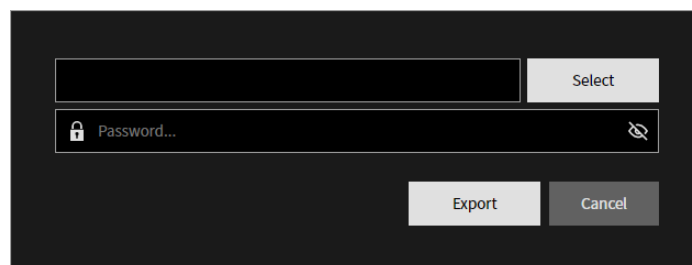

This opens the file selection dialog box.

3. Enter the file name and click "Save".

This returns you to the setting screen.

4. Enter the password to set for the file, then click "Export".

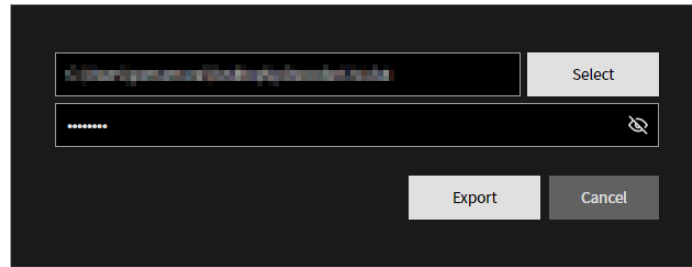

Item	Description	Range
Password	Set the password for the file to be exported.	Alphanumerics and symbols (1 to 64 characters)

Once export has completed successfully, a message saying so will be displayed.

Importing IP Decoder Information

Import an exported file and register in bulk the information for all IP Decoders saved in that file. Information about IP Decoders registered prior to importing the file will be deleted.

1. Click "Import" on the main screen.

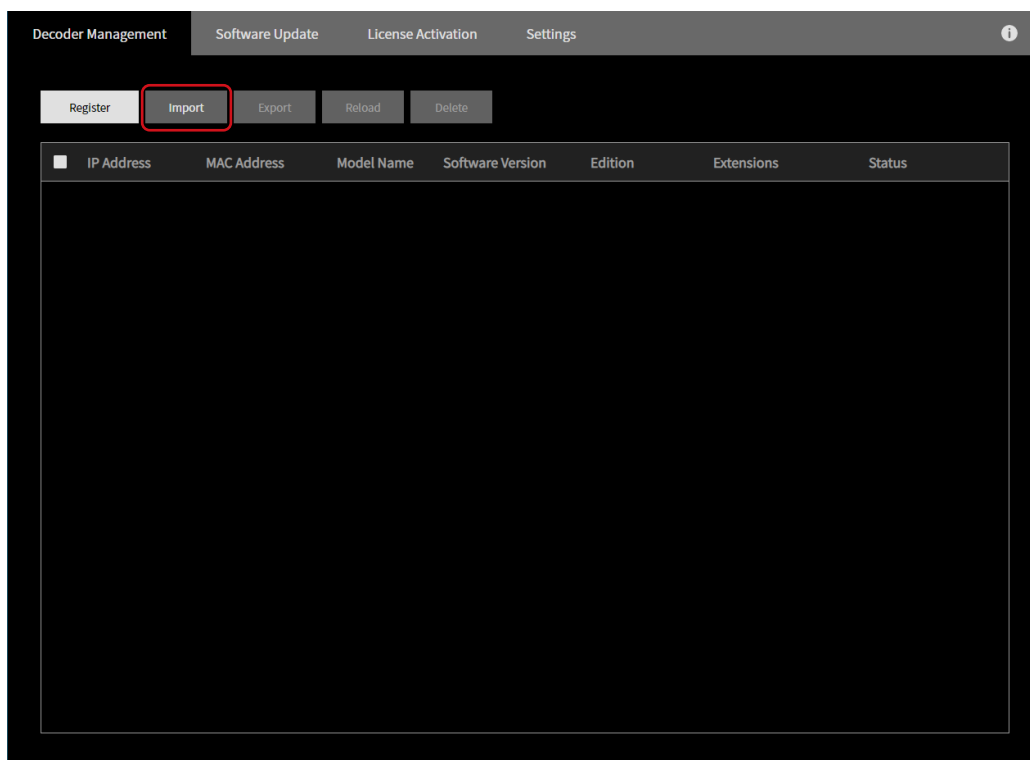

This displays the setting screen.

2. Click "Select".

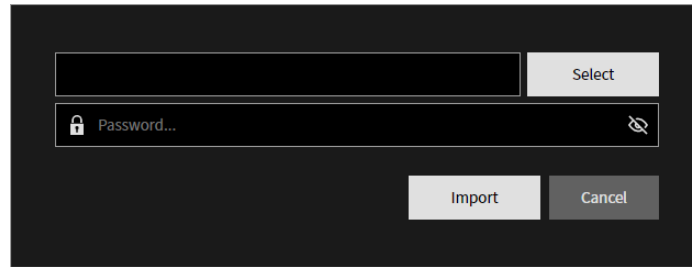

This opens the file selection dialog box.

3. Select the file to import and click "Open".

This returns you to the setting screen.

4. Enter the password set when the file was exported, then click "Import".

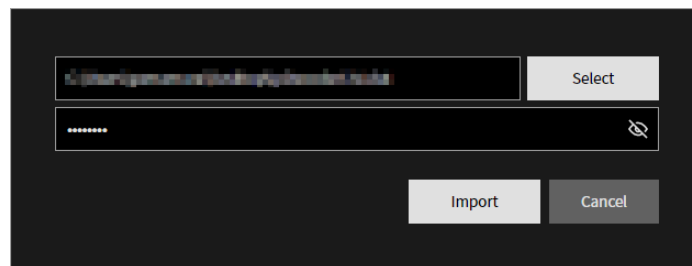

Once import has completed successfully, a message saying so will be displayed.

Software Updates

You can upgrade the software in bulk for multiple IP Decoders. Download the upgrade file from the EIZO website (www.eizoglobal.com) ahead of time.

1. Select the "Software Update" tab from the main screen.

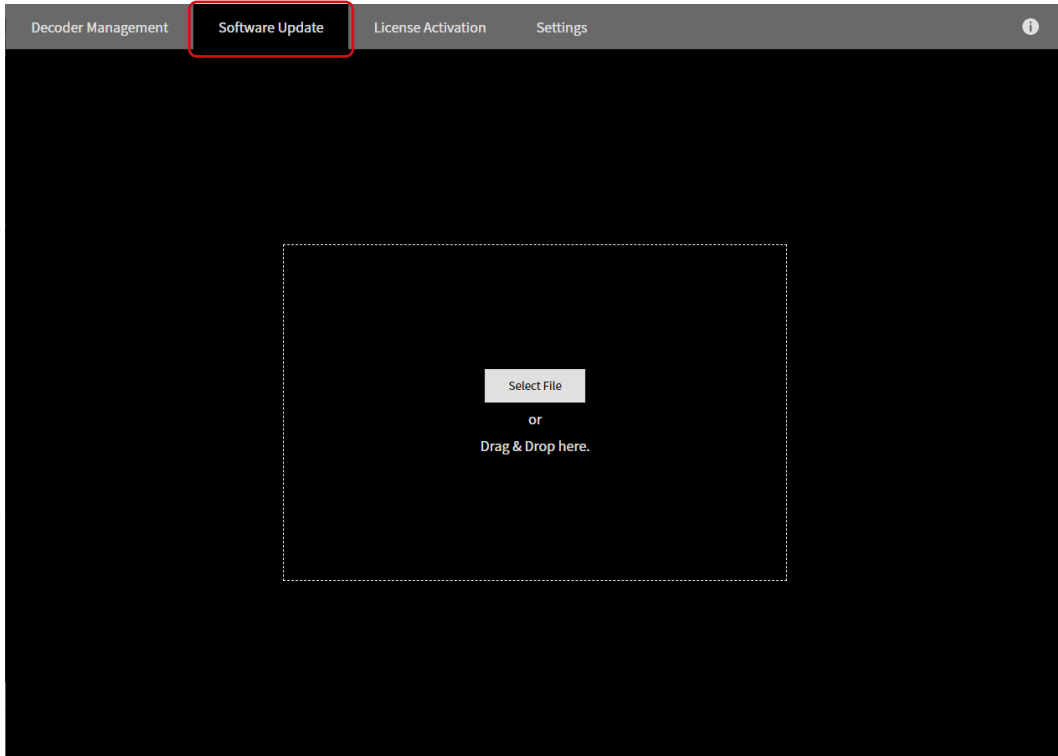

2. Drag and drop the upgrade file into the frame in the middle of the screen. You can also specify the file by clicking "Select File".

The IP Decoders that can be upgraded with this selected update are shown in the list.

3. Select the IP Decoders to upgrade. Check the topmost check box to select all IP Decoders in the list.

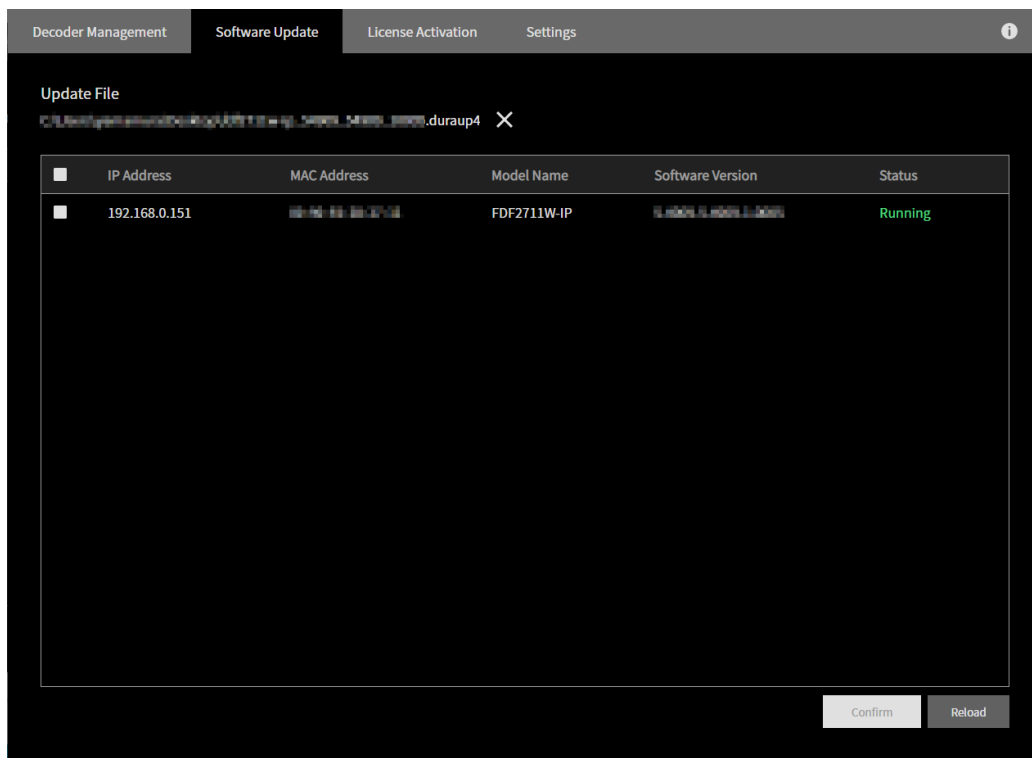

4. Click "Confirm".
A confirmation message is displayed.
5. Click "OK".
Once the upgrade has completed successfully, a message saying so will be displayed. Any IP Decoders that failed to upgrade will be displayed in a message.

License Activation

You can change the software edition to "Enterprise" or activate the license for extensions in bulk for multiple IP Decoders.

1. Select the "License Activation" tab from the main screen.

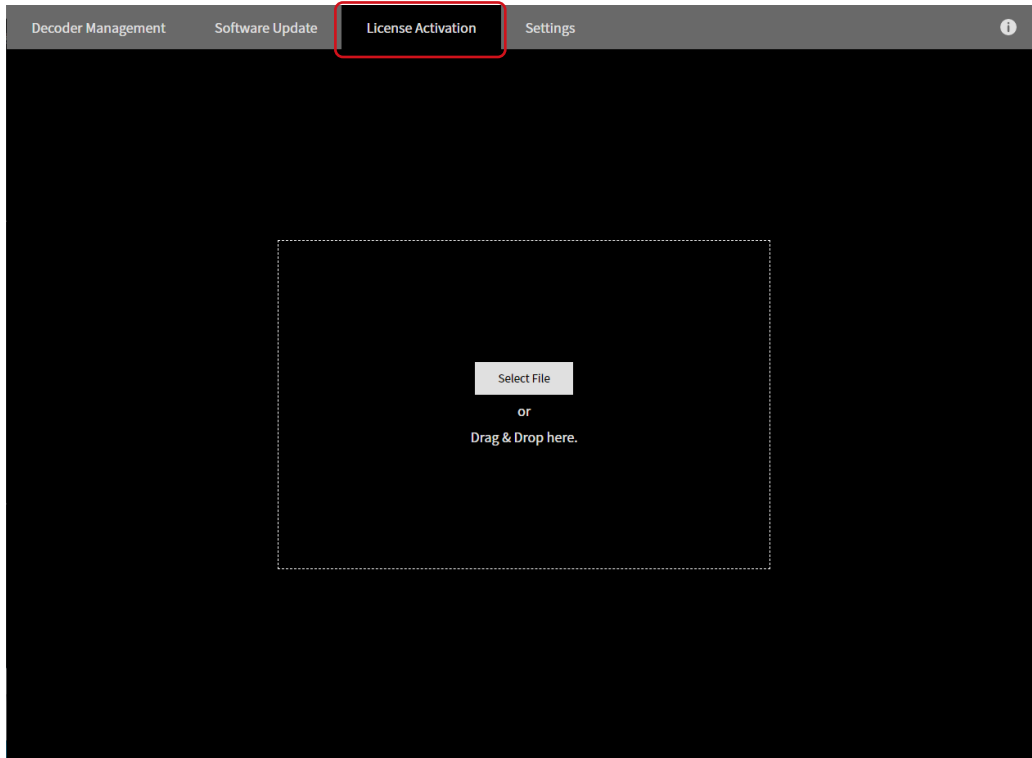

2. Drag and drop the license file into the frame in the middle of the screen, or specify the file with the "Select File" button.

Displays the list of registered IP Decoders.

3. Select the IP Decoder(s) for license activation. Check the topmost check box to select all IP Decoders in the list.

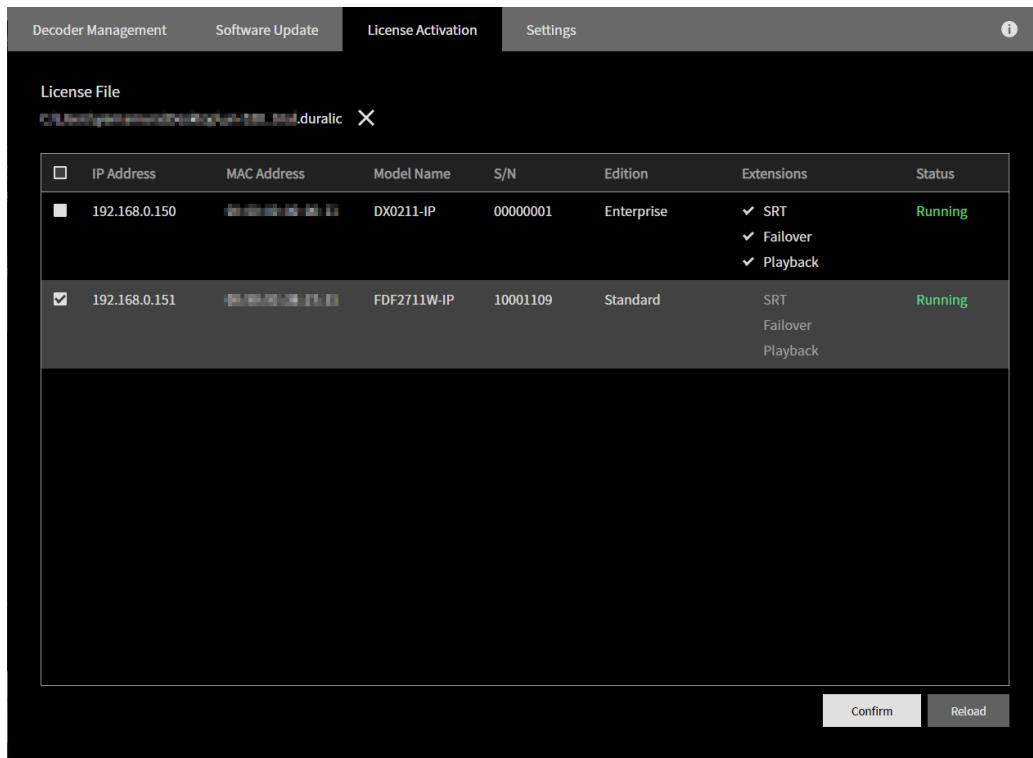

4. Click "Confirm".
A confirmation message is displayed.
5. Click "OK".
Once activation has completed successfully, a message saying so will be displayed. Any IP Decoders that failed to be activated will be displayed in a message.

Diagnostic Reporting

Files containing IP Decoder logs and settings data will be created when a problem arises in order to send this information to EIZO. These files are encrypted, which means that the administrator cannot check them.

1. Move your mouse over the IP Decoder you want to create a report for on the main screen, and click the  mark.

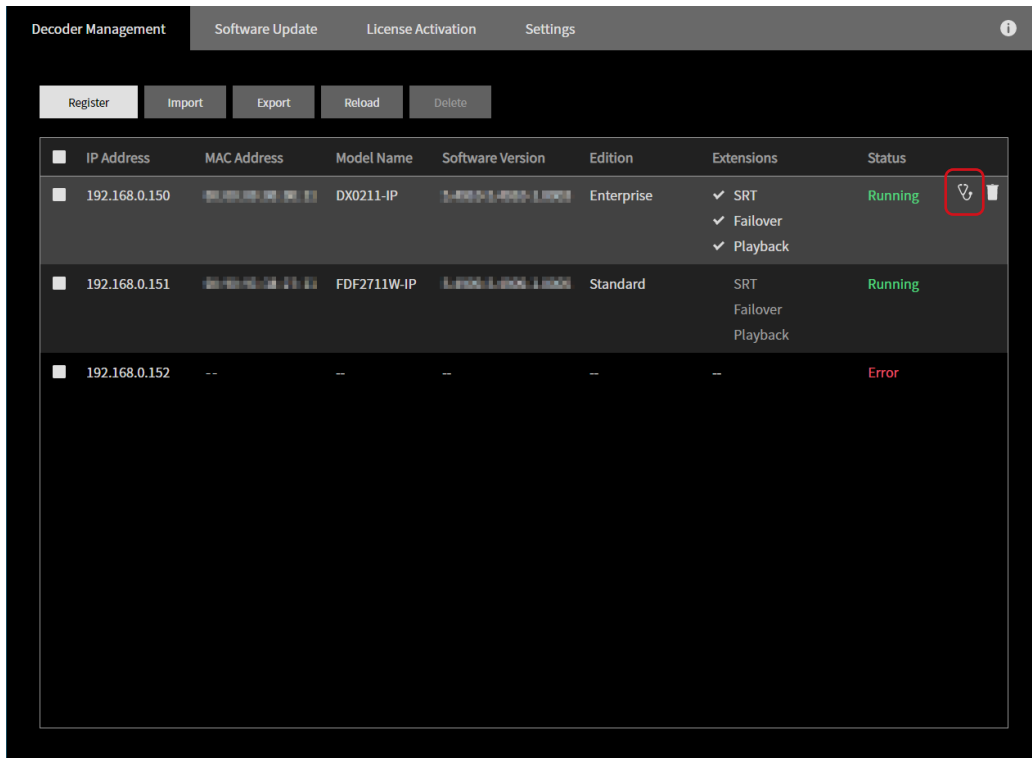

This displays the Diagnostic Reporting screen.

- Execute "Network Trace" and "Screen Capture" if needed.

Network Trace

Clicking "Execute" will capture one minute's worth of network communication information for the IP Decoder. (Can be used if the software version is 5.3000 or later.)

Screen Capture

Clicking "Execute" will capture the currently displayed contents for the IP Decoder. You can confirm the screen capture by clicking "Preview". An error image will be captured if the IP Decoder is not putting out an image. (Only available in the "Enterprise" edition.)

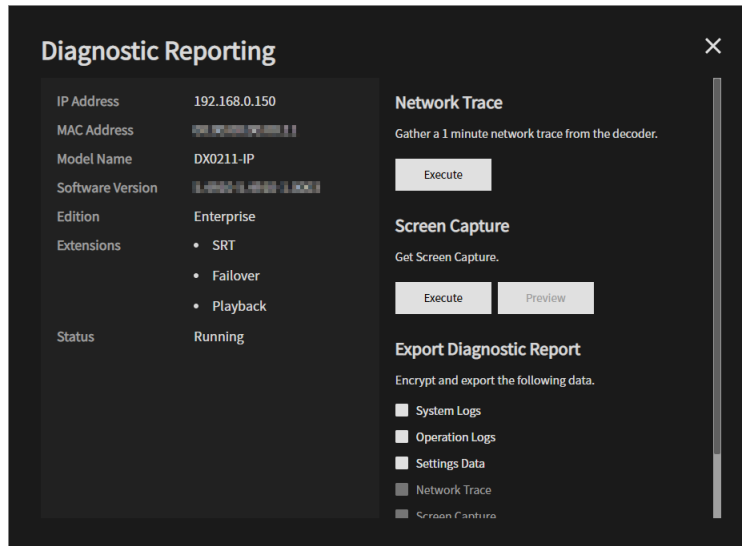

- In "Export Diagnostic Report", select the items you wish to save as the diagnostics report and click "Execute".

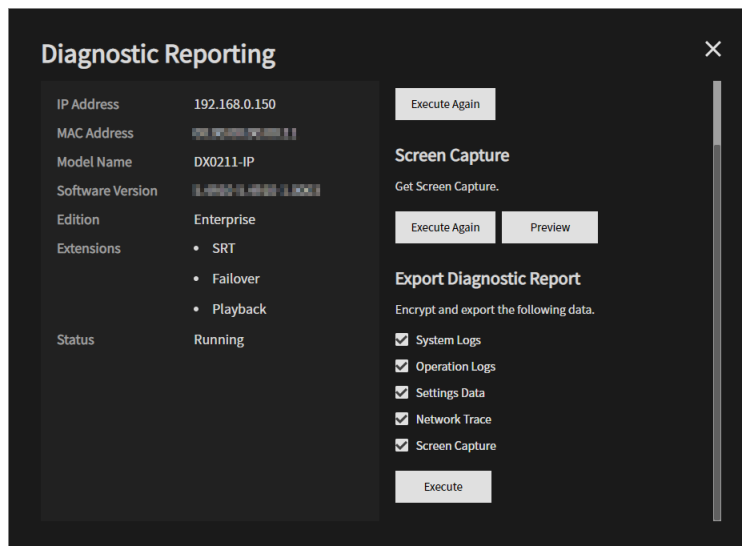

A confirmation message is displayed.

4. Click "Select".

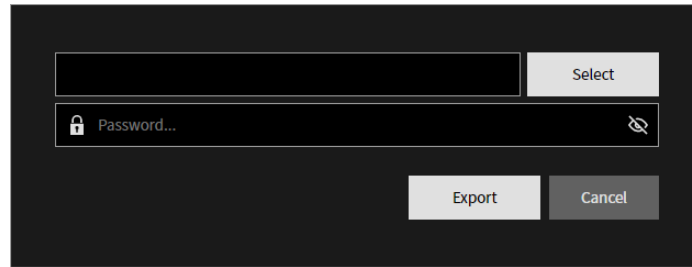

This opens the file selection dialog box.

5. Enter the file name and click "Save".
This returns you to the setting screen.

6. Enter the password to set for the file, then click "Export".

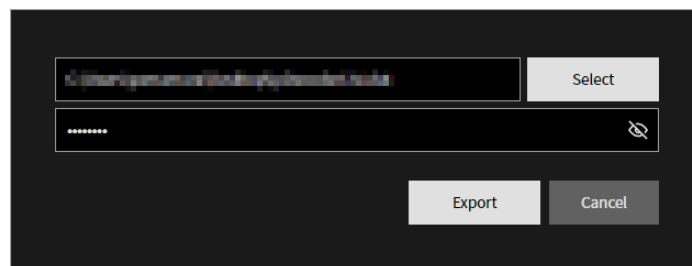

Item	Description	Range
Password	Set the password for the file to be saved.	Alphanumerics and symbols (1 to 64 characters)

Once the Diagnostic Report has saved successfully, a message saying so will be displayed.

EIZO IP Decoder Utility Settings

Set the language and network interface from "Language" and "Network Interface".

1. Select the "Settings" tab from the main screen.

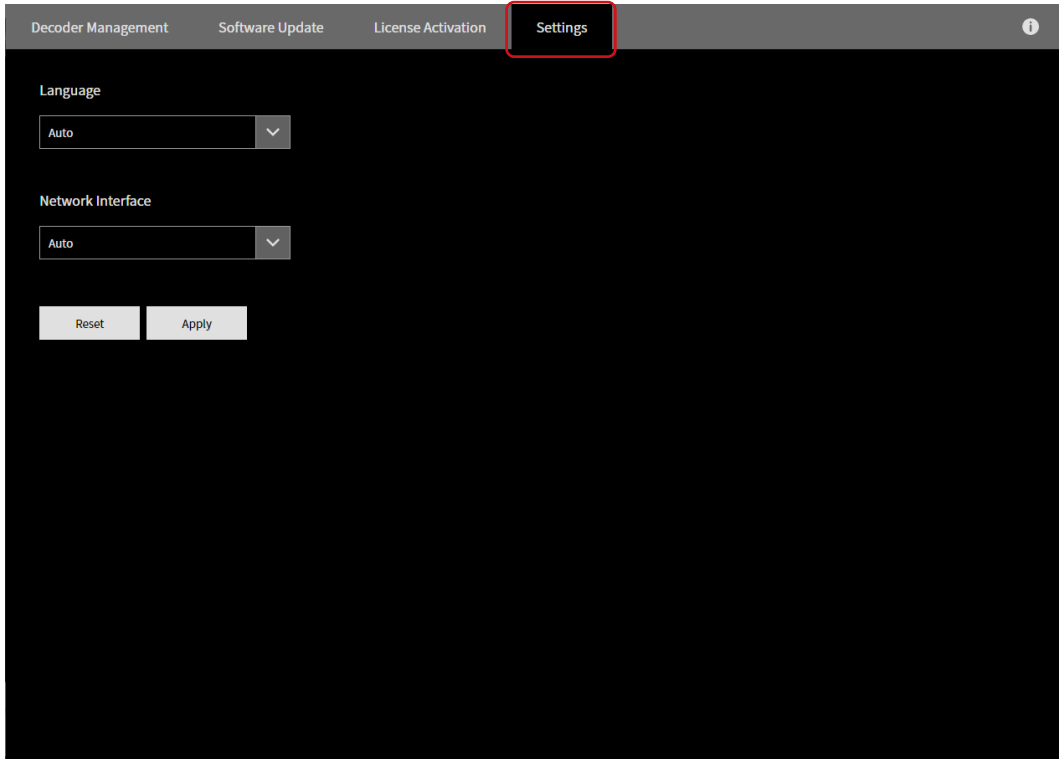

2. Set the various items, and click "Apply".

Item	Description	Range
Language	Set the display language of the menu and the settings screen. Default setting: "Auto"	Auto / Japanese / English
Network Interface	Set the network interface to use. Default setting: "Auto"	Auto / (Network interface appropriate for usage environment)

A confirmation message is displayed.

3. Click "OK".
Clicking "Reset" will revert to default settings.

EIZO IP Decoder Utility Information

This software can show the following information.

- Version
- User's Manual
- End User License Agreement

1. Click the  on the main screen.
This displays the information screen.

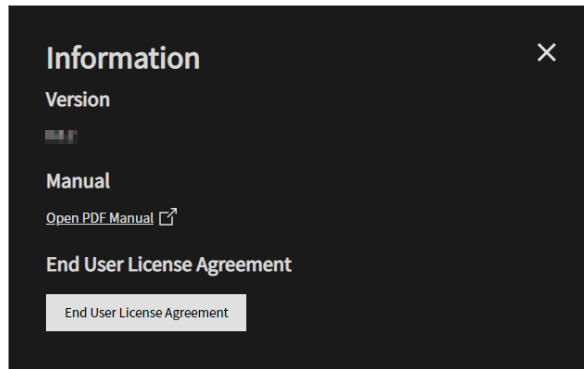

Item	Description
Version	This is the EIZO IP Decoder Utility you are using.
Manual	Clicking "Open PDF Manual" will display the User's Manual.
End User License Agreement	Clicking "End User License Agreement" will display the content of the agreement.

Error Codes

"Software Update" errors

Error Codes	Cause
SOF-000	There is a problem with the specified upgrade file.
SOF-999	There is an internal error in the IP Decoder.
SOF-U01	There is a communication error with the IP Decoder.
SOF-U02	Failed up upgrade.

"License Activation" errors

Error Codes	Cause
LIC-001, LIC-004	The specified license file does not include the IP Decoder information.
LIC-002	The license file is no longer valid.
LIC-003	This is a license file for a different product.
LIC-999	There is an internal error in the IP Decoder.
LIC-U01	There is a communication error with the IP Decoder.
Other codes	The license file format may be incorrect, or the IP Decoder software version may be outdated.

Appendix

Trademark

Microsoft, Windows, Internet Explorer, Microsoft Edge and .NET Framework are registered trademarks of Microsoft Corporation in the United States and other countries.

EIZO, the EIZO Logo, ColorEdge, CuratOR, DuraVision, FlexScan, FORIS, RadiCS, RadiForce, RadiNET, Raptor and ScreenManager are registered trademarks of EIZO Corporation in Japan and other countries.

ColorEdge Tablet Controller, ColorNavigator, EcoView NET, EIZO EasyPIX, EIZO Monitor Configurator, EIZO ScreenSlicer, G-Ignition, i•Sound, Quick Color Match, RadiLight, Re/Vue, SafeGuard, Screen Administrator, Screen InStyle and UniColor Pro are trademarks of EIZO Corporation.

All other company names, product names, and logos are trademarks or registered trademarks of their respective owners.

