

Instructions for Use

RadiForce® RX660

Color LCD monitor

Important









Please read this “Instructions for Use”, and “Installation Manual” (separate volume) carefully to familiarize yourself with safe and effective usage.

Please retain this manual for future reference.

-
- For monitor adjustment and settings, refer to the “Installation Manual”.
 - For the latest product information including the “Instructions for Use”, refer to our web site :
<http://www.eizoglobal.com>
-

SAFETY SYMBOLS

This manual and this product use the safety symbols below. They denote critical information. Please read them carefully.

 <p>WARNING Failure to abide by the information in a WARNING may result in serious injury and can be life threatening.</p>	 <p>CAUTION Failure to abide by the information in a CAUTION may result in moderate injury and/or property or product damage.</p>
	<p>Indicates a warning or caution. For example,  indicates an “electrical shock” hazard.</p>
	<p>Indicates a prohibited action. For example,  means “Do not disassemble”.</p>
	<p>Indicates a mandatory action. For example,  means “Ground the unit”.</p>

This product has been adjusted specifically for use in the region to which it was originally shipped. If operated outside this region, the product may not perform as stated in the specifications.

No part of this manual may be reproduced, stored in a retrieval system, or transmitted, in any form or by any means, electronic, mechanical, or otherwise, without the prior written permission of EIZO Corporation. EIZO Corporation is under no obligation to hold any submitted material or information confidential unless prior arrangements are made pursuant to EIZO Corporation’s receipt of said information. Although every effort has been made to ensure that this manual provides up-to-date information, please note that EIZO monitor specifications are subject to change without notice.

PRECAUTIONS

IMPORTANT

- This product has been adjusted specifically for use in the region to which it was originally shipped. If the product is used outside the region, it may not operate as specified in the specifications.
- To personal safety and proper maintenance, please read carefully this section and the caution statements on the monitor.

Location of the Caution Statements

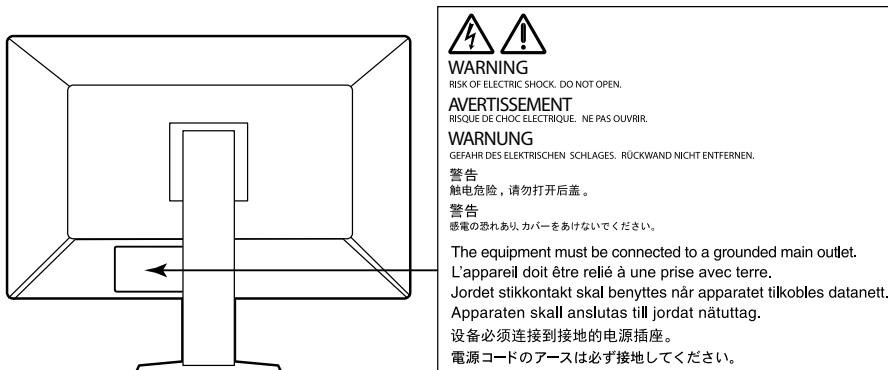

Symbols on the unit

Symbol	This symbol indicates	
	Main Power Switch:	Press to turn the monitor's main power off.
	Main Power Switch:	Press to turn the monitor's main power on.
	Power button:	Press to turn the monitor's power on or off.
	Alternating current	
	Alerting electrical hazard	
	CAUTION:	Refer to "SAFETY SYMBOLS" (page 2).
	WEEE marking:	Product must be disposed of separately; materials may be recycled.
	CE marking:	EU conformity mark in accordance with the provisions of Council Directive and/or Regulation (EU).
	Manufacturer	
	Date of manufacture	

WARNING

If the unit begins to emit smoke, smells like something is burning, or makes strange noises, disconnect all power connections immediately and contact your EIZO representative for advice.

Attempting to use a malfunctioning unit may result in fire, electric shock, or equipment damage.

Do not open the cabinet or modify the unit.

Opening the cabinet or modifying the unit may result in fire, electric shock, or burn.



Refer all servicing to qualified service personnel.

Do not attempt to service this product yourself as opening or removing covers may result in fire, electric shock, or equipment damage.

Keep small objects or liquids away from the unit.

Small objects accidentally falling through the ventilation slots into the cabinet or spillage into the cabinet may result in fire, electric shock, or equipment damage. If an object or liquid falls/spills into the cabinet, unplug the unit immediately. Have the unit checked by a qualified service engineer before using it again.



Place the unit at a sturdy and stable place.

A unit placed on an inadequate surface may fall and result in injury or equipment damage. If the unit falls, disconnect the power immediately and ask your local EIZO representative for advice. Do not continue using a damaged unit. Using a damaged unit may result in fire or electric shock.

Use the unit in an appropriate location.

Otherwise, fire, electric shock, or equipment damage may result.

- Do not place outdoors.
- Do not place in any form of transportation (ships, aircraft, trains, automobiles, etc.).
- Do not place in dusty or humid environments.
- Do not place in locations where water may be splashed on the screen (bathrooms, kitchens, etc.)
- Do not place in locations where steam comes in direct contact with the screen.
- Do not place near heat generating devices or humidifiers.
- Do not place in locations where the product is subject to direct sunlight.
- Do not place in environments with inflammable gas.
- Do not place in environments with corrosive gases (such as sulfur dioxide, hydrogen sulfide, nitrogen dioxide, chlorine, ammonia, and ozone)
- Do not place in environments with dust, components that accelerate corrosion in the atmosphere (such as sodium chloride and sulfur), conductive metals, and so on



To avoid danger of suffocation, keep the plastic packing bags away from babies and children.

Use the enclosed power cord and connect to the standard power outlet in your country.

Be sure to use within the rated voltage of the power cord. Otherwise, fire or electric shock may result.

Power supply: 100-240Vac 50/60Hz

To disconnect the power cord, grasp the plug firmly and pull.

Tugging on the cord may damage and result in fire or electric shock.



The equipment must be connected to a grounded main outlet.

Failure to do so may result in fire or electric shock.



Use the correct voltage.

- The unit is designed for use with a specific voltage only. Connection to another voltage than specified in this "Instructions for Use" may cause fire, electric shock, or equipment damage.
Power supply: 100-240Vac 50/60Hz
- Do not overload your power circuit, as this may result in fire or electric shock.

 **WARNING**

Handle the power cord with care.

- Do not place the cord underneath the unit or other heavy objects.
- Do not pull on or tie the cord.

If the power cord becomes damaged, stop using it. Using of a damaged cord may result in fire or electric shock.



For electrical safety, do not connect or disconnect the power cord in the presence of patients.

Never touch the plug and power cord if it begins to thunder.

Touching them may result in electric shock.



When attaching an arm stand, please refer to the user's manual of the arm stand and install the unit securely.

Otherwise, the unit may become detached, resulting in injury and/or equipment damage. Before installation, make sure that desks, walls, or any other installation surface has adequate mechanical strength. If the unit falls, please ask your local EIZO representative for advice. Do not continue using a damaged unit. Using a damaged unit may result in fire or electric shock. When reattaching the tilt stand, please use the same screws and tighten them securely.

Do not touch a damaged LCD panel directly with bare hands.

Liquid crystal is poisonous. If any part of your skin comes in direct contact with the panel, wash thoroughly. If liquid crystal enters your eyes or mouth, immediately flush with large amounts of water and seek medical attention.



Fluorescent backlight lamps contain mercury (the products that have LED backlight lamps contain no mercury), dispose according to local, state or federal laws.

Exposure to elemental mercury can result in effects on the nervous system, including tremors, memory loss, and headaches.



CAUTION

Handle with care when carrying the unit.

Disconnect the power cord and cables when moving the unit. Moving the unit with the power cord or cables attached is dangerous and may result in injury.

Carry or place the unit according to the correct specified methods.

- When carrying, grasp and firmly hold the unit as shown in the illustration below.
- Monitors of size 30 inches and above are heavy. When unpacking and/or carrying the monitor, ensure at least two people are utilized.

Dropping the unit may result in injury or equipment damage.

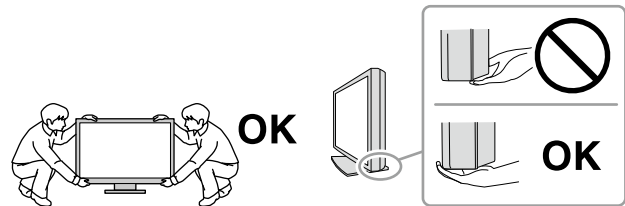

Do not block the ventilation slots on the cabinet.

- Do not place any objects on the ventilation slots.
- Do not install the unit in a place with poor ventilation or inadequate space.
- Do not use the unit laid down or upside down.

Blocking the ventilation slots prevents proper airflow and may result in fire, electric shock, or equipment damage.



Do not touch the plug with wet hands.

Doing so may result in electrical shock.



Use an easily accessible power outlet.

This is to facilitate disconnecting the power in case of a problem.

Periodically clean the area around the power plug and the ventilation slot of the monitor.

Dust, water, or oil on the plug may result in fire.

Unplug the unit before cleaning it.

Cleaning the unit while it is plugged into a power outlet may result in electric shock.

If you plan to leave the unit unused for an extended period of time, disconnect the power cord from the wall socket after turning off the power switch for the safety and the power conservation.

This product is suitable for placing near patients, but not for direct contact with patients.

For users in the territory of the EEA and Switzerland:

Any serious incident that has occurred in relation to the device should be reported to the Manufacturer and the Competent Authority of the Member State in which the user and/or patient is established.

Notice for this monitor

Intended use

This product is intended to be used in displaying and viewing digital images for review, analysis and diagnosis by trained medical practitioners. It does not support the display of mammography images for diagnosis.

Caution: Federal law (USA) restricts this device to sale by or on the order of a physician.

Attention

- This product should be set to horizontal view mode when used for the purposes mentioned above.
- This product may not be covered by warranty for uses other than those described in this manual.
- The specifications noted in this manual are only applicable when the following are used:
 - Power cords provided with the product
 - Signal cables specified by us
- Only use optional products manufactured or specified by us with this product.

Precautions for Use

- Otherwise, parts (such as the LCD panel or the fan) may deteriorate in the long-term. Periodically check that they are operating normally.
- When the screen image is changed after displaying the same image for extended periods of time, an afterimage may appear. Use the screen saver or power save function to avoid displaying the same image for extended periods of time.
- If the monitor displays continuously over a long period of time, dark smudges or burn-in may appear. To maximize the life of the monitor, we recommend the monitor be turned off periodically.
- An afterimage may appear even after a short time period has elapsed depending on the displayed image. If this occurs, changing the image or leaving the power off for a few hours may solve the problem.
- The backlight of the LCD panel has a fixed lifetime. When the screen becomes dark or begins to flicker, please contact your local EIZO representative.
- The screen may have defective pixels or a small number of light dots on the screen. This is due to the characteristics of the panel itself, and is not a malfunction of the product.
- Do not press on the panel or edge of the frame strongly, as this may result in display malfunctions, such as interference patterns, etc. If pressure is continually applied to the panel, it may deteriorate or damage your panel. (If the pressure marks remain on the panel, leave the monitor with a black or white screen. The symptom may disappear.)
- Do not scratch or press on the panel with any sharp objects, as this may result in damage to the panel. Do not attempt to brush with tissues as this may scratch the panel.
- Depending on the environment, the value measured by the built-in illuminance sensor may differ from the value shown on a stand-alone illuminometer.
- When the monitor is cold and brought into a room or the room temperature goes up quickly, dew condensation may occur on the interior and exterior surfaces of the monitor. In that case, do not turn the monitor on. Instead wait until the dew condensation disappears, otherwise it may cause some damage to the monitor.

To Use the Monitor for a Long Time

● Maintenance

- The display quality of monitors is affected by the quality level of input signals and the degradation of the product. Perform visual checks and periodic constancy tests to comply with medical standards / guidelines according to your application, and carry out calibration as necessary. Use of the RadiCS monitor quality control software enables you to perform high-level quality control that meets medical standards / guidelines.
- It takes about 15 minutes for the performance of electrical parts to stabilize. Please wait 15 minutes or more after the monitor power has been turned on or the monitor has recovered from the power saving mode, and then adjust the monitor.
- We recommend that monitors be set to the recommended level or lower to reduce changes in luminosity caused by long-term use and maintain stable brightness.
- Perform correlation using RadiCS/RadiCS LE to adjust the measurement result of the Integrated Front Sensor to the measurement result of the UX1 sensor for reference. Periodical correlation enables the measurement accuracy of the Integrated Front Sensor equivalent to that of the UX1 sensor. For details, refer to RadiCS/RadiCS LE User's Manual.

● Cleaning

Periodic cleaning is recommended to keep the monitor looking new and to prolong its operation lifetime.

Gently wipe off any dirt on the cabinet or panel surface with a soft cloth soaked in a small amount of water or one of the chemicals listed below.

Chemicals that may be used for cleaning

Material name	Product name
Ethanol	Ethanol
Isopropyl alcohol	Isopropyl alcohol
Chlorhexidine	Hibitane
Benzalkonium chloride	Welpas
Alkyldiaminoethylglycine	Tego 51
Glutaral	Cidex Plus28

Attention

- Do not use chemicals on a frequent basis. Chemicals such as alcohol and antiseptic solution may cause gloss variation, tarnishing, and fading of the cabinet or panel, and also quality deterioration of the image.
- Never use any thinner, benzene, wax, and abrasive cleaner, which may damage the cabinet or panel.
- Do not let chemicals come into direct contact with the monitor.

Note

- The optional ScreenCleaner is recommended for cleaning the cabinet and panel surface.

To use the monitor comfortably

- Staring at the monitor for a long time tires your eyes. Take a 10-minute rest every hour.
- Look at the screen from a proper distance and from a proper angle.

CONTENTS

PRECAUTIONS	3
IMPORTANT	3
Notice for this monitor	7
Intended use	7
Precautions for Use	7
To Use the Monitor for a Long Time	8
● Maintenance.....	8
● Cleaning	8
To use the monitor comfortably	8
CONTENTS	9
Chapter 1 Introduction	10
1-1. Features	10
1-2. Package Contents	12
● EIZO LCD Utility Disk	12
1-3. Controls and Functions	14
Chapter 2 Installation / Connection	15
2-1. Before Installing the Product	15
● Installation Requirements	15
2-2. Connecting Cables	16
2-3. Turning On the Power	19
2-4. Adjusting the Screen Height and Angle	19
2-5. Installing the Cable Cover	20
Chapter 3 No-Picture Problem	21
Chapter 4 Specifications	22
4-1. Specifications List	22
4-2. Compatible Resolutions	23
4-3. Optional Accessories	23
Appendix	24
Trademark	24
License / Copyright	24
Medical Standard	24
EMC Information	25
FCC Declaration of Conformity	29
Declaration of compliance with India RoHS	30
Recycling Information/ Informationen zum Thema Recycling/ Informations sur le recyclage/ Сведения по утилизации	i

Chapter 1 Introduction

Thank you very much for choosing an EIZO color LCD monitor.

1-1. Features

● High degree of freedom of layout

This product has the PbyP (Picture by Picture) and PinP (Picture in Picture) functions that can display up to three signals at the same time.

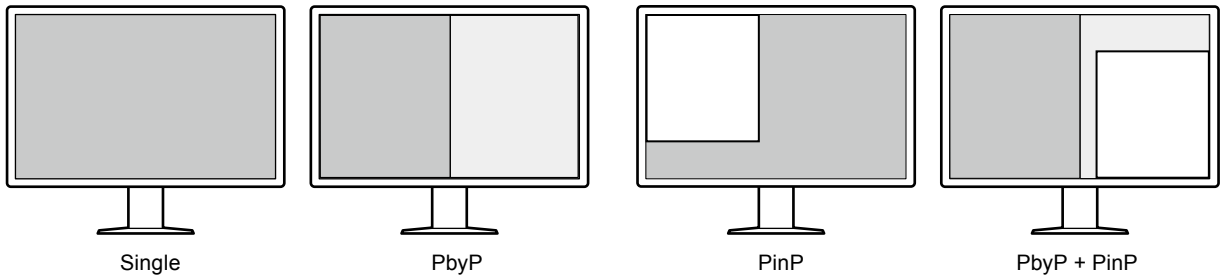



● Simple wiring

In addition to a DisplayPort input terminal, an output terminal is also provided.

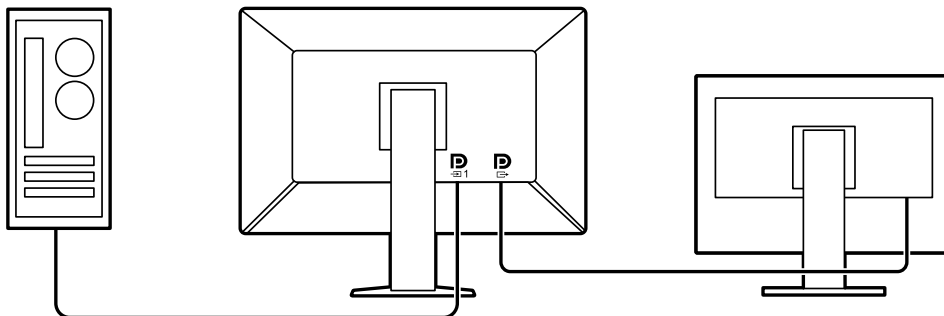
- From the output terminal (), a signal can be output to a different monitor.



- In order to display images in PbyP, two signal cables usually need to be connected between the PC and the monitor. On this model, you can connect it to the PC using one cable. You only need to connect the supplied DisplayPort cable (PP028) between the output terminal () and the input terminal ().

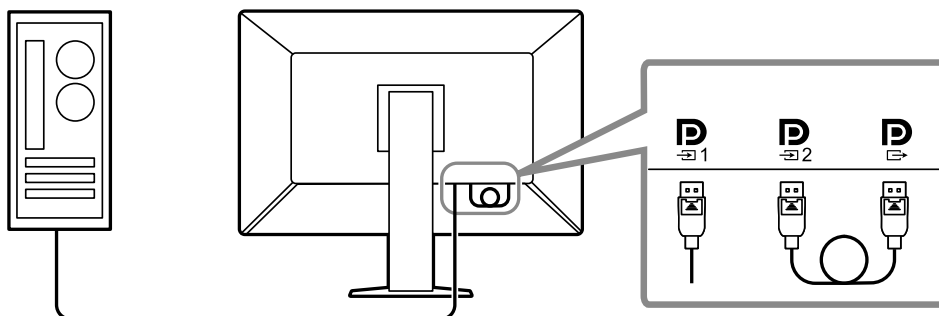

● Space-saving design

The monitor has two USB upstream ports. You can operate two PCs using one set of USB devices (mouse, keyboard, etc.) by switching between the PCs.

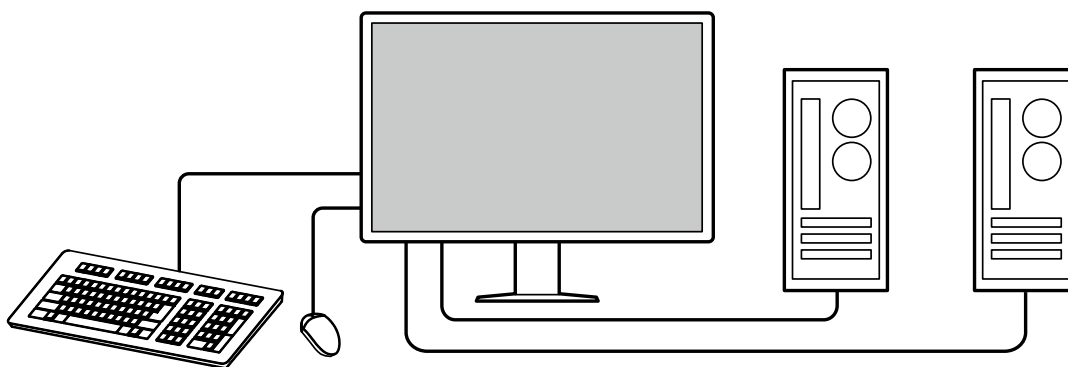

● Monitor operation from the mouse and keyboard

Using the RadiCS / RadiCS LE monitor quality control software, you can perform the following monitor operations using the mouse and keyboard:

- Switching CAL Switch modes
- Switching input signals
- Displaying or hiding the PinP sub window (Hide-and-Seek)
- Switching PCs used to operate USB devices (Switch-and-Go)

Note

- The RadiCS / RadiCS LE software allows you to display or hide the PinP sub window and switch the PC used to operate USB devices at the same time. For more information about the setup procedure, refer to RadiCS / RadiCS LE User's Manual.
-

● Quality control

- This monitor has a built-in calibration sensor (Integrated Front Sensor). This sensor enables the monitor to perform calibration (SelfCalibration) and Grayscale Check independently.

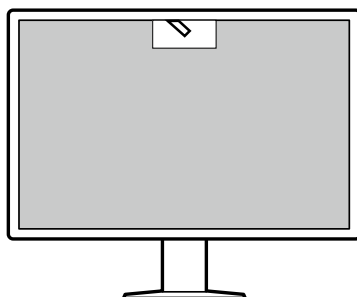

- Using RadiCS LE that is attached to the monitor, you can manage history related to the monitor, and the SelfCalibration target and execution schedule.
- The RadiCS monitor quality control software enables you to perform quality control that meets medical standards / guidelines.

1-2. Package Contents

Check that all of the following items are contained in the package. If any of these are missing or damaged, contact your dealer or local EIZO representative listed on the attached sheet.

Note

- It is recommended that the box and packing materials be stored so that they can be used to move or transport this product.

- Monitor
- Power cord

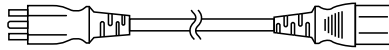

- Digital signal cable: PP300 x 2
DisplayPort - DisplayPort



- Digital signal cable: PP028 x 1
DisplayPort - DisplayPort

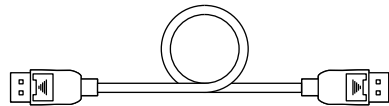

- Digital signal cable: DD300DL x 1
DVI - DVI (dual link)

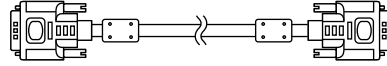

- USB cable: UU300 x 2

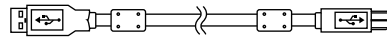

- Cable cover (Left)
- Cable cover (Right)
- EIZO LCD Utility Disk (CD-ROM)
- Instructions for Use

● EIZO LCD Utility Disk

The CD-ROM contains the following items. Refer to "Readme.txt" on the disk for software startup procedures or file reference procedures.

- Readme.txt file
- RadiCS LE monitor quality control software (for Windows)
- User's Manual
 - Monitor Installation Manual
 - RadiCS LE User's Manual
- Outline dimensions

RadiCS LE

RadiCS LE enables you to perform the following quality control and monitor operations. For more information about the software or setup procedures, refer to RadiCS LE User's Manual.

Quality control

- Executing calibration
- Displaying test results in a list and creating a test report
- Setting the SelfCalibration target and execution schedule

Monitor operations

- Switching CAL Switch modes
- Switching input signals
- Displaying or hiding the PinP sub window (Hide-and-Seek)
- Switching PCs used to operate USB devices (Switch-and-Go)
- Entering power saving mode (Backlight Saver)

Attention

- The specifications of RadiCS LE are subject to change without notice. The latest version of RadiCS LE is available for download from our web site: <http://www.eizoglobal.com>

To use RadiCS LE

For information on how to install and use RadiCS LE, refer to RadiCS LE User's Manual (on the CD-ROM).

When using RadiCS LE, connect the monitor to your PC using the supplied USB cable. For more information about how to connect the monitor, see "2-2. Connecting Cables" (page 16).

Note

- In an environment where it is difficult to connect the USB cable, enabling DDC communication allows you to RadiCS LE without having to use the USB cable. For information on how to configure DDC communication, refer to the Installation Manual (on the CD-ROM). In view of the response time and operation stability, USB connection is recommended.
-

1-3. Controls and Functions

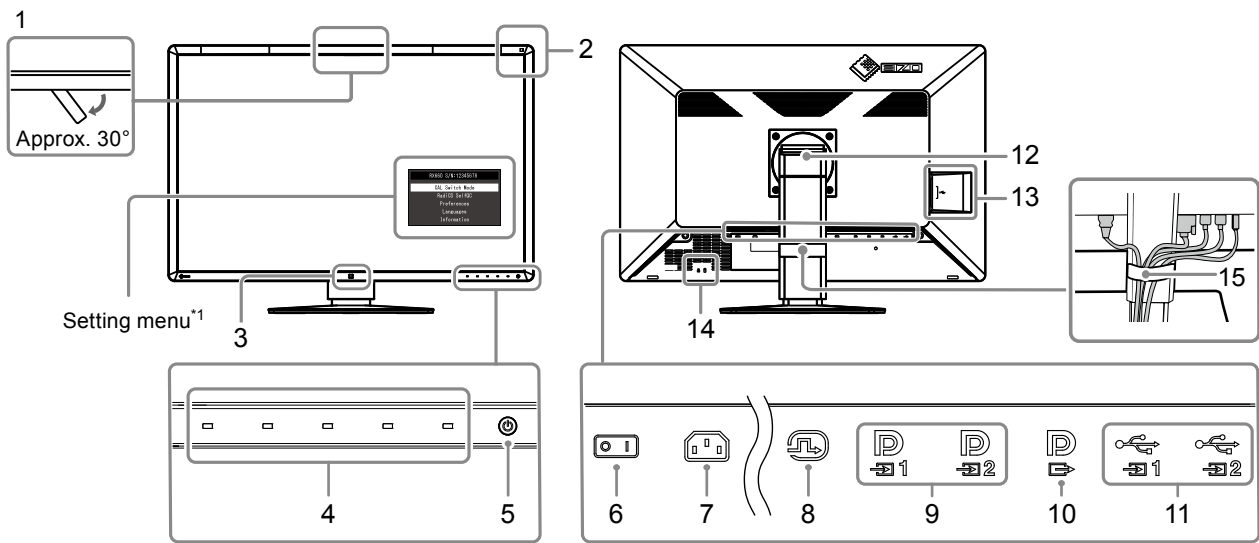

1. Integrated Front Sensor (Movable)	This sensor is used to perform calibration and Grayscale Check.
2. Ambient Light Sensor	This sensor measures environmental illumination. Environmental illuminance measurement is performed using the RadiCS / RadiCS LE quality control software.
3. Presence Sensor	This sensor detects movements made by a person in front of the monitor.
4. Operation switches	Displays the operation guide. Set menus according to the operation guide.
5. ⏻ switch	Turns the power on or off. The switch indicator is lit when you turn the power on. The indicator color differs depending on the monitor's operation status. Green: Monitor in operation, Orange: Power saving mode, Off: Main power / power off
6. Main power switch	Turns the main power on or off. ○ : Off, : On
7. Power connector	Connects the power cord.
8. DVI-D connector	Connect it to the PC. This corresponds to single screen display, display on the right screen in PbyP mode, and display on the sub window in PinP mode.
9. DisplayPort input connector	Connect it to the PC. D₁ : This corresponds to single screen display or display on the left screen in PbyP mode. D₂ : This corresponds to display on the right screen in dual screen mode or display on the sub window in PinP mode.
10. DisplayPort output connector	To set up a daisy-chain connection, connect the cable to the input port of another monitor. When this connector is connected to D₂ , the signal input to D₁ can be displayed in PbyP mode. For more information, see "2-2. Connecting Cables" (page 16).
11. USB upstream port	Connect this port to the PC when you use software that needs a USB connection or connect a USB device (peripheral device that supports USB) to the USB downstream port.
12. Stand	The height and angle can be adjusted.
13. USB downstream port	Connect it to a USB device. To set up a daisy-chain connection, connect the cable to the USB upstream port of another monitor.
14. Security lock slot	Complies with Kensington's MicroSaver security system.
15. Cable holder	Holds the monitor cables.

*1 For information on how to use, refer to the Installation Manual (on the CD-ROM).

Chapter 2 Installation / Connection

2-1. Before Installing the Product

Carefully read "PRECAUTIONS" (page 3) and always follow the instructions.

If you place this product on a lacquer-coated desk, the color may adhere to the bottom of the stand due to the composition of the rubber. Check the desk surface before use.

● Installation Requirements

When installing the monitor in a rack, ensure that there is adequate space around the sides, back and top of the monitor.

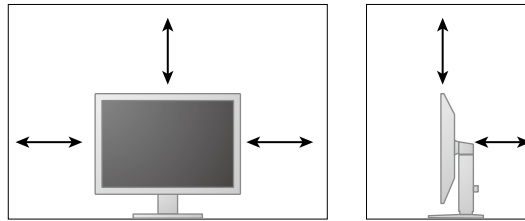

Attention

- Position the monitor so that there is no light to interfere with the screen.
-

2-2. Connecting Cables

Attention

- Check that the monitor and the PC are powered off.
- When replacing the current monitor with this monitor, refer to “4-2. Compatible Resolutions” (page 23) to change the PC settings for resolution and vertical scan frequency to those that are available for this monitor, before connecting the PC.

1. Connect signal cables.

Check the shapes of the connectors, and connect the cables. After connecting the DVI cable, tighten the fasteners to secure the connector.

Single screen display

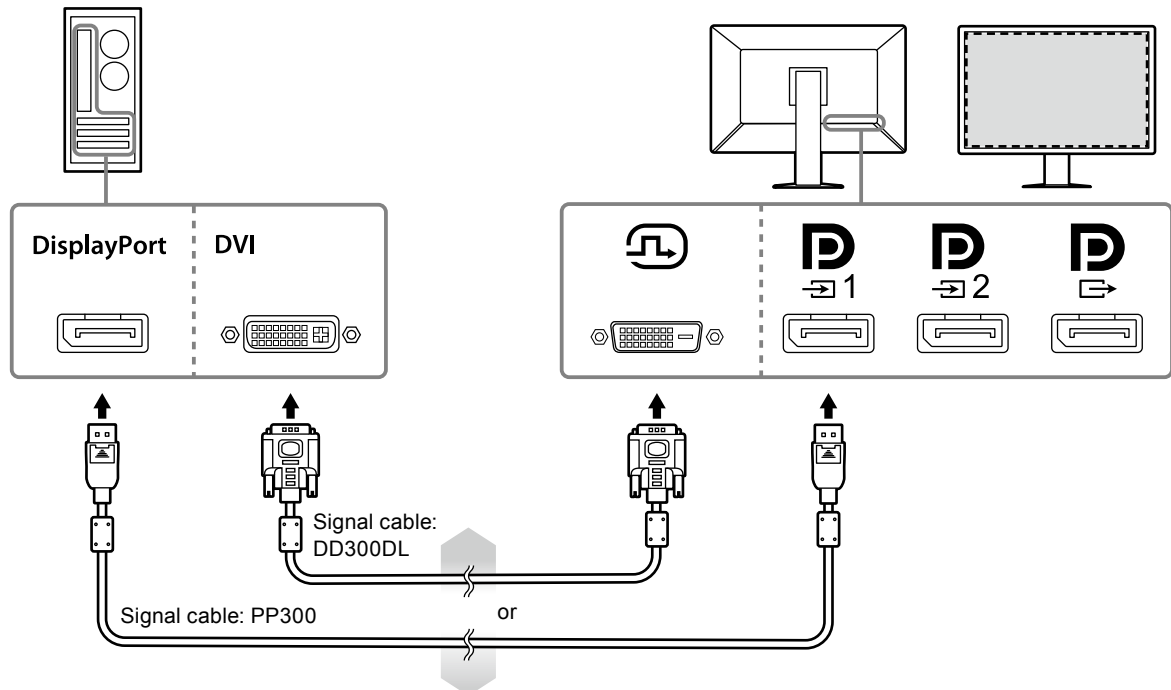

Attention

- When using the monitor for single screen display via DisplayPort, connect the monitor to the input connector  1.
- When the monitor is used for single screen display via DVI, the refresh rate (the frequency at which the image on the screen is refreshed) will be reduced. When using the monitor for single screen display, it is recommended that the monitor be connected to DisplayPort 1.
- When using the monitor for single screen display via DVI, you need to set "Input" in the Setting menu to "DVI". For details, refer to the Installation Manual (on the CD-ROM).

PbyP (dual-screen) display

Attention

- When using the monitor for PbyP display, you need to configure "Input" in the Setting menu to select a combination of signals to be displayed. For details, refer to the Installation Manual (on the CD-ROM).
- When the monitor is used in PbyP mode to display images from two PCs, use of some quality control features such as calibration may be restricted.

For DisplayPort 1 / DisplayPort 2

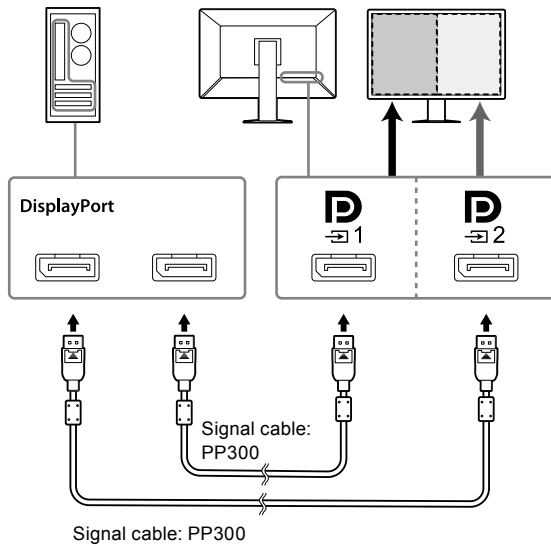

For DisplayPort 1 / DVI

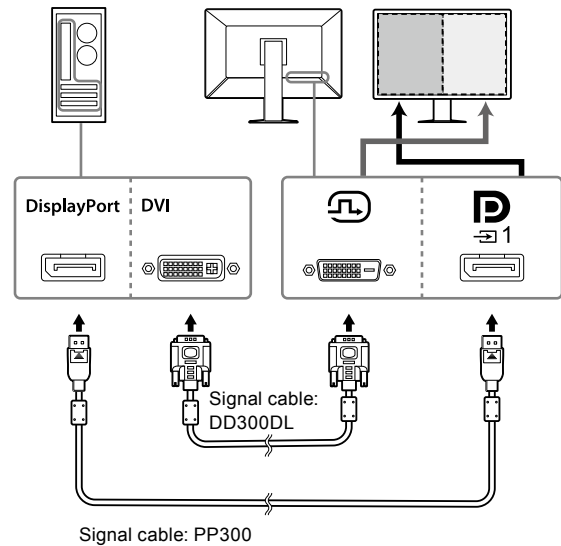

Note

- When the supplied DisplayPort cable (PP028) is connected to $\text{D}_{\Rightarrow 1}$ and $\text{D}_{\Rightarrow 2}$, the signal input to $\text{D}_{\Rightarrow 1}$ can be displayed in PbyP mode. In this case, you need to set "Signal Format" - "DisplayPort 1" - "Version" in the Setting menu to "1.2", and "Daisy Chain" to "On".
- Remove the D_{\Rightarrow} cap before connecting the cable to $\text{D}_{\Rightarrow 1}$ and $\text{D}_{\Rightarrow 2}$.

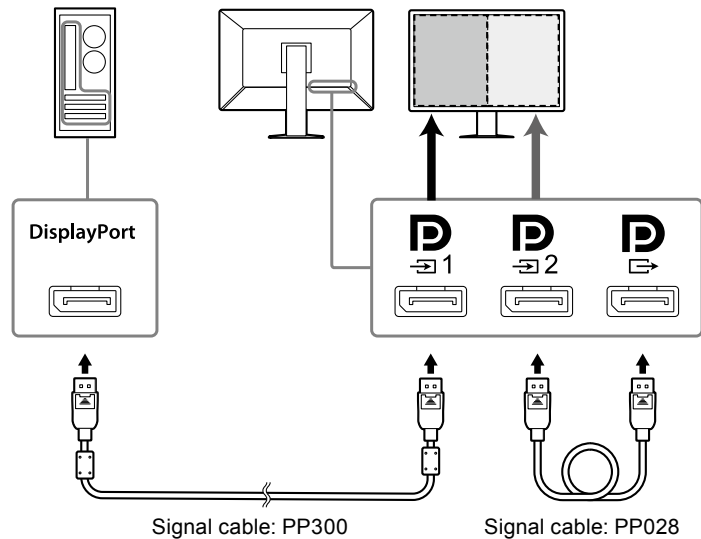

Setting up a daisy-chain connection to another monitor

The signal input to  is output to another monitor.

Attention

- Visit the EIZO website for information about monitors and graphic boards that can be used for the daisy-chain connection: <http://www.eizoglobal.com>
- When connecting the monitor in a daisy-chain configuration, you need to set “Signal Format” - “DisplayPort 1” - “Version” in the Setting menu to “1.2”, and “Daisy Chain” to “On”.
- Remove the  cap before connecting the signal cable.

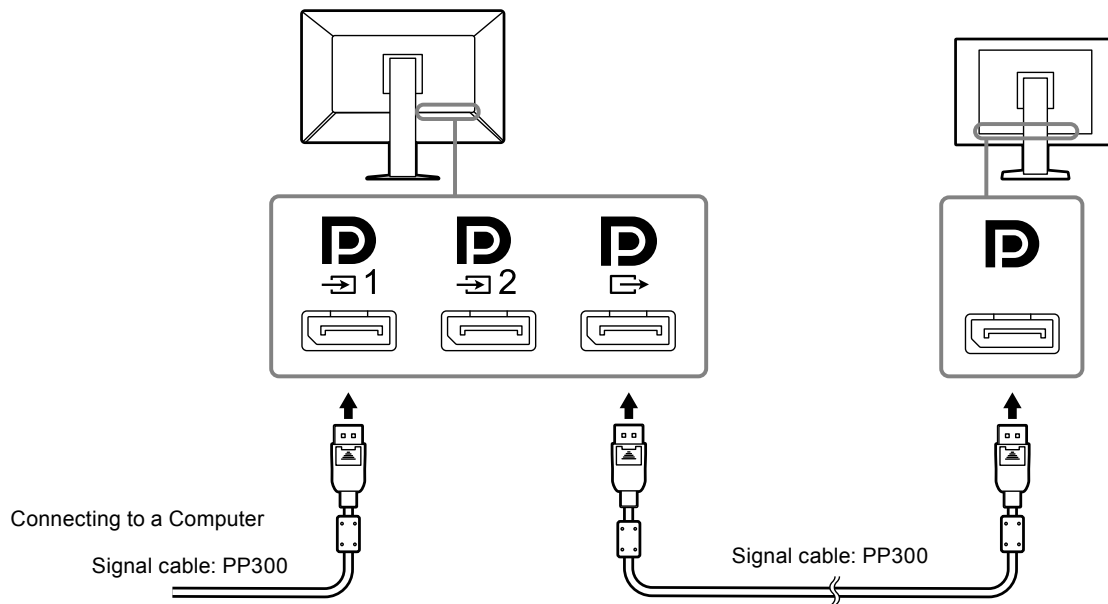



2. Plug the power cord into a power outlet and the power connector on the monitor.

Insert the power cord fully into the monitor.

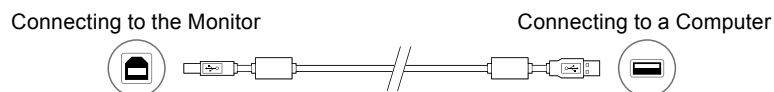
3. When you use RadiCS / RadiCS LE or connect a USB device (peripheral device that supports USB) to the monitor, connect the USB cable to the monitor's USB upstream port and the PC.



Attention

- When connecting the monitor to a PC on which RadiCS / RadiCS LE has been installed, connect the cable to .
- Remove the cap before using .

Note

- When the monitor is used in PbyP mode to display images from two PCs, use of some quality control features such as calibration may be restricted.

2-3. Turning On the Power

1. Touch to turn on the power to the monitor.

The power switch indicator of the monitor lights up green.

If the indicator does not light up, see “Chapter 3 No-Picture Problem” (page 21).

Note

- When the power of the monitor is not on, touching any button except  causes  to flash.

2. Turn on the PC.

The screen image appears.

If an image does not appear, refer to “Chapter 3 No-Picture Problem” (page 21) for additional advice.

Attention

- For the maximum power saving, it is recommended that the Power button be turned off. When not using the monitor, you can turn off the main power supply or disconnect the power plug so that the power is cut completely.

Note

- In order to maximize the monitor's lifespan by impeding brightness degradation and to reduce power consumption, carry out the following:
 - Use the power saving function of the PC or monitor.
 - Turn off the monitor after using it.

2-4. Adjusting the Screen Height and Angle

Hold left and right edge of the monitor with both hands, and adjust the screen height, tilt and swivel of the screen to the best condition for working.

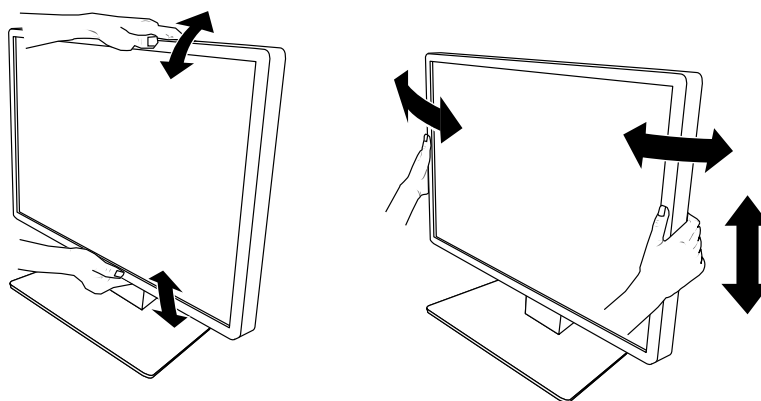

Attention

- After the adjustment is finished, make sure that the cables are correctly connected.

2-5. Installing the Cable Cover

1. Tidy the cables into the cable holder.

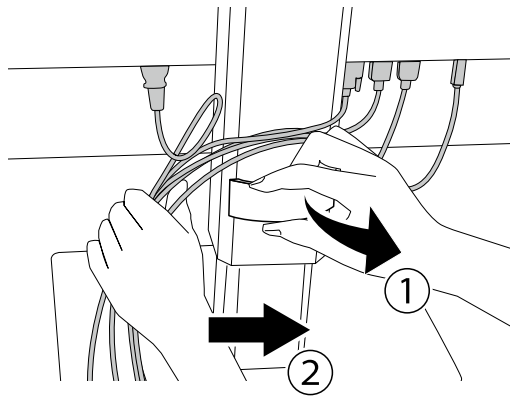

2. Install the cable cover.

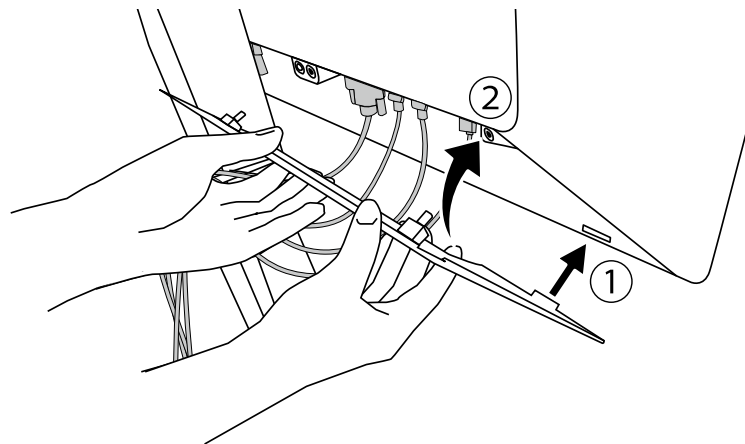











Example: Installing the Cable Cover (Right)

Note

- To remove the cable cover, pull it toward you.
-

Chapter 3 No-Picture Problem

Problem	Possible cause and remedy
1. No picture <ul style="list-style-type: none"> Power switch indicator does not light up 	<ul style="list-style-type: none"> Check whether the power cord is connected properly. Turn the main power switch on. Touch . Turn off the main power, and then turn it on again.
<ul style="list-style-type: none"> Power switch indicator lights up: Green 	<ul style="list-style-type: none"> Increase "Brightness", "Contrast", or "Gain" in the Setting menu. For details, refer to the Installation Manual (on the CD-ROM). Turn off the main power, and then turn it on again.
<ul style="list-style-type: none"> Power switch indicator lights up: Orange 	<ul style="list-style-type: none"> Switch the input signal. For details, refer to the Installation Manual (on the CD-ROM). Move the mouse or press any key on the keyboard. Check whether the PC is turned on. If the Presence Sensor is set to "On", the monitor may be in power saving mode. Try moving closer to the monitor. Check whether the signal cable is connected properly. If "DisplayPort 1" is selected for the input signal, connect it to .  is used for output when a daisy-chain connection is set up. Turn off the main power, and then turn it on again.
<ul style="list-style-type: none"> Power switch indicator blinks: Orange, Green 	<ul style="list-style-type: none"> Connect via the signal cable specified by EIZO. Turn off the main power, and then turn it on again. If the signal cable is connected to DisplayPort 1 () , try switching the DisplayPort version. For details, refer to the Installation Manual (on the CD-ROM).
2. The message below appears.	This message appears when the signal is not input correctly even though the monitor is functioning properly.
<ul style="list-style-type: none"> This message appears when no signal is input. Example: 	<ul style="list-style-type: none"> The message shown left may appear, because some PCs do not output the signal immediately after power-on. Check whether the PC is turned on. Check whether the signal cable is connected properly. Switch the input signal. For details, refer to the Installation Manual (on the CD-ROM). If the signal cable is connected to DisplayPort 1 () , try switching the DisplayPort version. Is the signal cable connected to  to display a DisplayPort signal on a single screen? The signal cannot be displayed if the cable is connected to  or . Turn off the main power, and then turn it on again.
<ul style="list-style-type: none"> The message indicates that the input signal is out of the specified frequency range. Example: 	<ul style="list-style-type: none"> Check whether the PC is configured to meet the resolution and vertical scan frequency requirements of the monitor (see "4-2. Compatible Resolutions" (page 23)). Reboot the PC. Select an appropriate setting using the graphics board's utility. For more information, refer to the User's Manual of the graphics board.

Chapter 4 Specifications

4-1. Specifications List

Type		RX660: Anti-Glare RX660-AR: Anti-Reflection
LCD Panel	Type	Color (IPS)
	Backlight	LED
	Size	76 cm (30.0 inch)
	Resolution (H x V)	3280 × 2048
	Display Size (H x V)	645.5 mm × 403.0 mm
	Pixel Pitch	0.1968 mm
	Display Colors	10-bit (DisplayPort*1): 1073.74 million colors (Max.) 8-bit (DisplayPort*1 / DVI): 16.77 million colors
	Viewing Angles (H / V, typical)	176° / 176°
	Recommended Brightness	500 cd/m ²
	Response Time (typical)	25 ms (black -> white -> black)
	Video Signals	Input Terminals
Output Terminal		DisplayPort × 1
Horizontal scanning frequency		31 kHz - 127 kHz
Vertical scan frequency		DisplayPort: 29 Hz - 61 Hz (720×400 : 69 Hz - 71 Hz) DVI: 22 Hz - 61 Hz (720×400 : 69 Hz - 71 Hz)
Frame Synchronization mode		29.5 Hz - 30.5 Hz, 59 Hz - 61 Hz
Dot clock		DisplayPort : 25.0 MHz - 440 MHz (Single screen display) 25.0 MHz - 240 MHz (PbyP / PinP) DVI : 25.0 MHz - 240 MHz
USB	Port	Upstream port × 2, downstream port × 3
	Standard	USB Specification Revision 2.0
Power	Input	100 - 240 VAC ±10 %, 50 / 60 Hz 1.95 A - 0.85 A
	Maximum Power Consumption	190 W or less
	Power Save Mode	1.6 W or less* ²
	Standby Mode	1.6 W or less* ³
Physical Specifications	Dimensions (W × H × D)	682.5 mm × 490.5 mm - 590.5 mm × 225.0 mm (Tilt: 0°) 682.5 mm × 533.0 mm - 633.0 mm × 296.0 mm (Tilt: 30°)
	Dimensions (W × H × D) (Without Stand)	682.5 mm × 441.0 mm × 88.0 mm
	Net Weight	Approx. 14.2 kg
	Net Weight (Without Stand)	Approx. 10.1 kg
	Height Adjustment Range	100 mm (Tilt: 0°)
	Tilt	Up 30°, down 5°
	Swivel	70°
Operating Environmental Requirements	Temperature	0 °C - 35 °C (32 °F - 95 °F)
	Humidity	20 % - 80 % R.H. (no condensation)
	Air Pressure	540 hPa - 1060 hPa

Transportation / Storage Environmental Requirements	Temperature	-20 °C - 60 °C (-4 °F - 140 °F)
	Humidity	10 % - 90 % R.H. (no condensation)
	Air Pressure	200 hPa - 1060 hPa

*1 The colors of DisplayPort signals displayed on the monitor may differ depending on the monitor settings. For details of display colors and settings, see "4-2. Compatible Resolutions" (page 23).

*2 When DisplayPort 1 input is used, the USB upstream port is not connected, "Input": "Single DisplayPort 1", "Power Save": "High", "DDC": "Off", "DP Power Save": "On", "DisplayPort 1" - "Version": "1.1", "Daisy Chain": "OFF", no external load is connected

*3 When the USB upstream port is not connected, "DP Power Save": "On", "DisplayPort 1" - "Version": "1.1", "DDC": "Off", "Daisy Chain": "OFF", no external load is connected

4-2. Compatible Resolutions

The monitor supports the following resolutions. For information about the compatible resolutions of the PinP sub window, refer to the Installation Manual.

√: Supported

Resolution (H x V)	Vertical frequency (Hz)	DisplayPort			DVI	
		Single screen display		Dual screen display (PbyP) ^{*3}	Single screen display	Dual screen display (PbyP)
		Ver. 1.2 ^{*1}	Ver. 1.1 ^{*2}			
720 × 400	70	√	√	√	√	√
640 × 480	60	√	√	√	√	√
800 × 600	60	√	√	√	√	√
1024 × 768	60	√	√	√	√	√
1280 × 1024	60	√	√	√	√	√
1600 × 1200	60	√	√	√	√	√
1640 × 2048	30	-	-	√	-	√
1640 × 2048	60	-	-	√ ^{*4}	-	√ ^{*4}
3280 × 2048	23	-	-	-	√	-
3280 × 2048	30	-	√ ^{*4}	-	√ ^{*4}	-
3280 × 2048	60	√ ^{*4}	-	-	-	-

*1 When "Daisy Chain" is set to "Off": 10-bit input, when "Daisy Chain" is set to "On": 8-bit input

*2 10 bit input

*3 Dual screen display using "DisplayPort 1 / DisplayPort 2": 10-bit input, dual screen display using "DisplayPort 1 / DVI": 8-bit input

*4 Recommended resolution

4-3. Optional Accessories

The following accessories are available separately.

For the latest information about the optional accessories and information about the latest compatible graphics board, refer to our web site. <http://www.eizoglobal.com>

Calibration Kit	EIZO "RadiCS UX1" Ver. 4.5.4 or later EIZO "RadiCS Version Up Kit" Ver. 4.5.4 or later
Network QC Management Software	EIZO "RadiNET Pro" Ver. 4.5.4 or later EIZO "RadiNET Pro Lite" Ver. 4.5.4 or later
Cleaning Kit	EIZO "ScreenCleaner"
Comfort Light for Reading Rooms	EIZO "RadiLight"

Appendix

Trademark

The terms HDMI and HDMI High-Definition Multimedia Interface, and the HDMI Logo are trademarks or registered trademarks of HDMI Licensing, LLC in the United States and other countries.

The DisplayPort Compliance Logo and VESA are registered trademarks of the Video Electronics Standards Association.

The SuperSpeed USB Trident Logo is a registered trademark of USB Implementers Forum, Inc.



Kensington and Microsaver are registered trademarks of ACCO Brands Corporation.

Thunderbolt is a trademark of Intel Corporation in the United States and/or other countries.

Microsoft, Windows and Windows Vista are registered trademarks of Microsoft Corporation in the United States and other countries.

Adobe is a registered trademark of Adobe Systems Incorporated in the United States and other countries.

Apple, Mac OS, Macintosh and ColorSync are registered trademarks of Apple Inc.

EIZO, the EIZO Logo, ColorEdge, DuraVision, FlexScan, FORIS, RadiCS, RadiForce, RadiNET, Raptor and ScreenManager are registered trademarks of EIZO Corporation in Japan and other countries.

ColorEdge Tablet Controller, ColorNavigator, CuratOR, EcoView NET, EIZO EasyPIX, EIZO Monitor Configurator, EIZO ScreenSlicer, G-Ignition, i Sound, Quick Color Match, Re/Vue, Screen Administrator and UniColor Pro are trademarks of EIZO Corporation.

All other company and product names are trademarks or registered trademarks of their respective owners.

License / Copyright

A round gothic bold bit map font designed by Ricoh is used for the characters displayed on this product.

Medical Standard

- It shall be assured that the final system is in compliance to IEC60601-1-1 requirement.
- Power supplied equipment can emit electromagnetic waves, that could influence, limit or result in malfunction of the monitor. Install the equipment in a controlled environment, where such effects are avoided.

Classification of Equipment

- Type of protection against electric shock : Class I
- EMC class: EN60601-1-2:2015 Group 1 Class B
- Classification of medical device (EU): Class I
- Mode of operation : Continuous
- IP Class : IPX0

EMC Information

The RadiForce series has a performance that appropriately displays images.

Environments of Intended Use

The RadiForce series is intended to be used in Professional healthcare facility environments such as clinics and hospitals.

The following environments are not suitable for the RadiForce series to be used:

- Home healthcare environments
- In the vicinity of high-frequency surgical equipments such as electrosurgical knives
- In the vicinity of short-wave therapy equipments
- RF shielded room of the medical equipment systems for MRI
- In shielded location Special environments
- Installed in vehicles including ambulances.
- Other special environments

WARNING

The RadiForce series requires special precautions regarding EMC and need to be installed. You need to carefully read EMC Information and the "PRECAUTIONS" section in this document, and observe the following instructions when installing and operating the product.

Be sure to use the cables attached to the product, or cables specified by EIZO.

Use of cables other than those specified or provided by EIZO of this equipment could result in increased electromagnetic emissions or decreased electromagnetic immunity of this equipment and improper operation.

Cable length: 3 m max.

The RadiForce series should not be used adjacent to or stacked with other equipment. If adjacent or stacked use is necessary, the equipment or system should be observed to verify normal operation in the configuration in which it will be used.

When using a portable RF communication equipment, keep it 30 cm (12 inches) or more away from any part, including cables, of the RadiForce series. Otherwise, degradation of the performance of this equipment could result.

Anyone who connects additional equipment to the signal input part or signal output parts, configuring a medical system, is responsible that the system complies with the requirements of IEC/EN60601-1-2.

Technical Descriptions

Electromagnetic emissions		
The RadiForce series is intended for use in the electromagnetic environment specified below.		
The customer or the user of the RadiForce series should assure that it is used in such an environment.		
Emission test	Compliance	Electromagnetic environment - Guidance
RF emissions CISPR11 / EN55011	Group 1	The RadiForce series uses RF energy only for its internal function. Therefore, its RF emission are very low and are not likely to cause any interference in nearby electronic equipment.
RF emissions CISPR11 / EN55011	Class B	The RadiForce series is suitable for use in all establishments, including domestic establishments and those directly connected to the public low-voltage power supply network that supplies buildings used for domestic purposes.
Harmonic emissions IEC / EN61000-3-2	Class D	
Voltage fluctuations / flicker emissions IEC / EN61000-3-3	Complies	

Electromagnetic immunity			
The RadiForce series has been tested at the following compliance levels according to the testing requirements for professional healthcare facility environments defined in IEC / EN60601-1-2. Customers and users of the RadiForce series must ensure that the RadiForce series is used in the following environments:			
Immunity test	Test level for professional healthcare facility environments	Compliance level	Electromagnetic environment - Guidance
Electrostatic discharge (ESD) IEC / EN61000-4-2	±8 kV contact discharge ±15 kV air discharge	±8 kV contact discharge ±15 kV air discharge	Floors should be wood, concrete or ceramic tile. If floors are covered with synthetic material, the relative humidity should be at least 30%.
Electrical fast transients / bursts IEC / EN61000-4-4	±2 kV power lines ±1 kV input / output lines	±2 kV power lines ±1 kV input / output lines	Mains power quality should be that of a typical commercial or hospital environment.
Surges IEC / EN61000-4-5	±1 kV line to line ±2 kV line to ground	±1 kV line to line ±2 kV line to ground	Mains power quality should be that of a typical commercial or hospital environment.
Voltage dips, short interruptions and voltage variations on power supply input lines IEC / EN61000-4-11	0 % U _T (100 % dip in U _T) 0.5 cycles and 1 cycle 70 % U _T (30 % dip in U _T) 25 cycles 0 % U _T (100 % dip in U _T) 5 sec	0 % U _T (100 % dip in U _T) 0.5 cycles and 1 cycle 70 % U _T (30 % dip in U _T) 25 cycles 0 % U _T (100 % dip in U _T) 5 sec	Mains power quality should be that of a typical commercial or hospital environment. If the user of the RadiForce series requires continued operation during power mains interruptions, it is recommended that the RadiForce series be powered from an uninterruptible power supply or a battery.
Power frequency magnetic fields IEC / EN61000-4-8	30 A/m (50 / 60 Hz)	30 A/m	Power frequency magnetic fields should be at levels characteristic of a typical location in a typical commercial or hospital environment. The product should be kept at least 15 cm away from the source of power frequency magnetic fields during use.

Electromagnetic immunity			
The RadiForce series has been tested at the following compliance levels according to the testing requirements for professional healthcare facility environments defined in IEC / EN60601-1-2. Customers and users of the RadiForce series must ensure that the RadiForce series is used in the following environments:			
Immunity test	Test level for professional healthcare facility environments	Compliance level	Electromagnetic environment - Guidance
Conducted disturbances induced by RF fields IEC / EN61000-4-6	Portable and mobile RF communications equipment should be used no closer to any part of the RadiForce series, including cables, than the recommended separation distance calculated from the equation applicable to the frequency of the transmitter. Recommended separation distance 3 Vrms 150 kHz - 80 MHz	3 Vrms	$d = 1.2\sqrt{P}$
Radiated RF fields IEC / EN61000-4-3	6 Vrms ISM bands between 150 kHz and 80 MHz 3 V/m 80 MHz - 2.7 GHz	6 Vrms 3 V/m	$d = 1.2\sqrt{P}$, 80 MHz - 800 MHz $d = 2.3\sqrt{P}$, 800 MHz - 2.7 GHz Where "P" is the maximum output power rating of the transmitter in watts (W) according to the transmitter manufacturer and "d" is the recommended separation distance in meters (m). Field strengths from fixed RF transmitters, as determined by an electromagnetic site survey ^{a)} , should be less than the compliance level in each frequency range ^{b)} . Interference may occur in the vicinity of equipment marked with the following symbol. 
Note 1	U_T is the a.c. mains voltage prior to application of the test level.		
Note 2	At 80 MHz and 800 MHz, the higher frequency range applies.		
Note 3	Guidelines regarding conducted disturbances induced by RF fields or radiated RF fields may not apply in all situations. Electromagnetic propagation is affected by absorption and reflection from structures, objects and people.		
Note 4	The ISM bands between 150 kHz and 80 MHz are 6.765 MHz to 6.795 MHz, 13.553 MHz to 13.567 MHz, 26.957 MHz to 27.283 MHz, and 40.66 MHz to 40.70 MHz.		
a)	Field strengths from fixed transmitters, such as base stations for radio (cellular/cordless) telephones and land mobile radios, amateur radio, AM and FM radio broadcast and TV broadcast cannot be predicted theoretically with accuracy. To assess the electromagnetic environment due to fixed RF transmitters, an electromagnetic site survey should be considered. If the measured field strength in the location in which the RadiForce series is used exceeds the applicable RF compliance level above, the RadiForce series should be observed to verify normal operation. If abnormal performance is observed, additional measures may be necessary, such as reorienting or relocating the RadiForce series.		
b)	Over the frequency range 150 kHz to 80 MHz, field strengths should be less than 3 V/m.		

Recommended separation distances between portable or mobile RF communication equipment and the RadiForce Series

The RadiForce series is intended for use in an electromagnetic environment in which radiated RF disturbances are controlled. The customer or the user of the RadiForce series can help prevent electromagnetic interference by maintaining a minimum distance between portable and mobile RF communications equipment (transmitters) and the RadiForce series. Immunity to proximity fields from following RF wireless communication equipments has been confirmed:

Test frequency (MHz)	Bandwidth ^{a)} (MHz)	Service ^{a)}	Modulation ^{b)}	Maximum power (W)	Minimum separation distance (m)	IEC / EN60601 test level (V/m)	Compliance level (V/m)
385	380 - 390	TETRA 400	Pulse modulation ^{b)} 18 Hz	1.8	0.3	27	27
450	430 - 470	GMRS 460, FRS 460	FM ±5 kHz deviation 1 kHz sine	2	0.3	28	28
710 745 780	704 - 787	LTE Band 13, 17	Pulse modulation ^{b)} 217 Hz	0.2	0.3	9	9
810 870 930	800 - 960	GSM 800 / 900, TETRA 800, iDEN 820 CDMA 850, LTE Band 5	Pulse modulation ^{b)} 18 Hz	2	0.3	28	28
1720 1845 1970	1700 - 1990	GSM 1800; CDMA 1900; GSM 1900; DECT; LTE Band 1, 3, 4, 25; UMTS	Pulse modulation ^{b)} 217 Hz	2	0.3	28	28
2450	2400 - 2570	Bluetooth, WLAN, 802.11 b/g/n, RFID 2450, LTE Band 7	Pulse modulation ^{b)} 217 Hz	2	0.3	28	28
5240 5500 5785	5100 - 5800	WLAN 802.11 a/n	Pulse modulation ^{b)} 217 Hz	0.2	0.3	9	9

a) For some services, only the uplink frequencies are included.

b) carrier are modulated using a 50 % duty cycle square wave signal.

The RadiForce series is intended for use in an electromagnetic environment in which radiated RF disturbances are controlled. For other portable and mobile RF communication equipments (transmitters), minimum distance between portable and mobile RF communications equipment (transmitters) and the RadiForce series as recommended below, according to the maximum output power of the communications equipment.

Rated maximum output power of transmitter (W)	Separation distance according to frequency of transmitter (m)		
	150 kHz to 80 MHz $d = 1.2\sqrt{P}$	80 MHz to 800 MHz $d = 1.2\sqrt{P}$	800 MHz to 2.7 GHz $d = 2.3\sqrt{P}$
0.01	0.12	0.12	0.23
0.1	0.38	0.38	0.73
1	1.2	1.2	2.3
10	3.8	3.8	7.3
100	12	12	23

For transmitters rated at a maximum output power not listed above, the recommended separation distance "d" in meters (m) can be estimated using the equation applicable to the frequency of the transmitter, where "P" is the maximum output power rating of the transmitter in watts (W) according to the transmitter manufacturer.

Note 1 At 80 MHz and 800 MHz, the separation distance for a higher frequency range applies.

Note 2 These guidelines may not apply in all situations. Electromagnetic propagation is affected by absorption and reflection from structures, objects and people.

Cable	Length
Signal cable: PP300	3 m
Signal cable: PP028	0.28 m
Signal cable: DD300DL	3 m
USB cable: UU300	3 m
Power cord (with earth)	3 m

FCC Declaration of Conformity

For U.S.A., Canada Only

FCC Declaration of Conformity

We, the Responsible Party

EIZO Inc.

5710 Warland Drive, Cypress, CA 90630

Phone: (562) 431-5011

declare that the product

Trade name: EIZO

Model: RadiForce RX660

is in conformity with Part 15 of the FCC Rules. Operation of this product is subject to the following two conditions: (1) this device may not cause harmful interference, and (2) this device must accept any interference received, including interference that may cause undesired operation.

This equipment has been tested and found to comply with the limits for a Class B digital device, pursuant to Part 15 of the FCC Rules. These limits are designed to provide reasonable protection against harmful interference in a residential installation. This equipment generates, uses, and can radiate radio frequency energy and, if not installed and used in accordance with the instructions, may cause harmful interference to radio communications. However, there is no guarantee that interference will not occur in a particular installation. If this equipment does cause harmful interference to radio or television reception, which can be determined by turning the equipment off and on, the user is encouraged to try to correct the interference by one or more of the following measures.

- * Reorient or relocate the receiving antenna.
- * Increase the separation between the equipment and receiver.
- * Connect the equipment into an outlet on a circuit different from that to which the receiver is connected.
- * Consult the dealer or an experienced radio/TV technician for help.

Changes or modifications not expressly approved by the party responsible for compliance could void the user's authority to operate the equipment.

Note

Use the attached specified cable below or EIZO signal cable with this monitor so as to keep interference within the limits of a Class B digital device.

- AC Cord
- Shielded Signal Cable (enclosed)

Canadian Notice

This Class B digital apparatus complies with Canadian ICES-003.

Cet appareil numérique de la classe B est conforme à la norme NMB-003 du Canada.

Declaration of compliance with India RoHS

We, EIZO Corporation, hereby declare and guarantee that this product has been designed and manufactured in compliance with the E-Waste management rule 2016 which prohibit the inclusion of the following substances except for the exemptions listed in schedule II.

- Lead, Mercury, Hexavalent Chromium, Polybrominated Biphenyls or Polybrominated Diphenyl Ethers exceeding a concentration of 0.1% by weight in homogeneous materials
- Cadmium exceeding a concentration of 0.01% by weight in homogeneous materials

For information on proper disposal and recycling of the product, please refer to the following website.
eizo.co.in/e-waste.php

Recycling Information/Informationen zum Thema Recycling/ Informations sur le recyclage/Сведения по утилизации

English

Deutsch

Français

Русский

Recycling Information

This product, when disposed of, is supposed to be collected and recycled according to your country's legislation to reduce environmental burden. When you dispose of this product, please contact a distributor or an affiliate in your country.

The contact addressees are listed on the EIZO website below.

<http://www.eizoglobal.com>

For recycling information for customers in Switzerland, please refer to the following website.

<http://www.swico.ch>

Informationen zum Thema Recycling

Dieses Produkt muss gemäß den Vorschriften Ihres Landes zur Entlastung der Umwelt recyclet werden. Wenden Sie sich bei der Entsorgung dieses Produkts an einen Verteiler oder eine Tochtergesellschaft in Ihrem Land.

Die Adressen zur Kontaktaufnahme sind auf der unten angegebenen Website von EIZO aufgeführt.

<http://www.eizoglobal.com>

Kunden in der Schweiz entnehmen Informationen zum Recycling der folgenden Website:

<http://www.swico.ch>

Informations sur le recyclage

Ce produit doit être jeté aux points de collecte prévus à cet effet et recyclé conformément à la législation de votre pays, afin de réduire l'impact sur l'environnement. Lorsque vous jetez ce produit, veuillez contacter un distributeur ou une société affiliée de votre pays.

Les adresses des distributeurs sont répertoriées sur le site Web EIZO ci-dessous.

<http://www.eizoglobal.com>

Pour les clients en Suisse, veuillez consulter le site Web suivant afin d'obtenir des informations sur le recyclage.

<http://www.swico.ch>

Información sobre reciclaje

Este producto debe desecharse y reciclarse según la legislación del país para reducir el impacto medioambiental. Cuando desee deshacerse de este producto, póngase en contacto con un distribuidor o una filial de su país.

Encontrará las direcciones de contacto en el sitio web de EIZO que se indica a continuación.

<http://www.eizoglobal.com>

Informazioni sul riciclaggio

Per lo smaltimento e il riciclaggio del presente prodotto, attenersi alle normative vigenti nel proprio paese per ridurre l'impatto ambientale. Per lo smaltimento, rivolgersi ad un distributore o un affiliato presenti nel proprio paese.

Gli indirizzi sono elencati nel sito Web EIZO riportato di seguito.

<http://www.eizoglobal.com>

Per informazioni sul riciclaggio per i clienti in Svizzera, consultare il sito Web riportato di seguito.

<http://www.swico.ch>

Återvinningsinformation

När denna produkt kasseras ska den hanteras och återvinnas enligt landets föreskrifter för att reducera miljöpåverkan. När du kasserar produkten ska du kontakta en distributör eller representant i ditt land.

Kontaktadresserna listas på EIZO-webbplatsen nedan.

<http://www.eizoglobal.com>

Πληροφορίες ανακύκλωσης

Το προϊόν αυτό, όταν απορρίπτεται, πρέπει να συλλέγεται και να ανακυκλώνεται σύμφωνα με τη νομοθεσία της χώρας σας έτσι ώστε να μην επιβαρύνει το περιβάλλον. Για να απορρίψετε το προϊόν, επικοινωνήστε με έναν αντιπρόσωπο ή μια θυγατρική εταιρεία στη χώρα σας.

Οι διευθύνσεις επικοινωνίας αναγράφονται στην τοποθεσία web της EIZO παρακάτω.

<http://www.eizoglobal.com>

Сведения по утилизации

По истечении срока службы данного продукта его следует принести на сборный пункт и утилизировать в соответствии с действующими предписаниями в вашей стране, чтобы уменьшить вредное воздействие на окружающую среду. Прежде чем выбросить данный продукт, обратитесь к дистрибьютору или в местное представительство компании в вашей стране.

Контактные адреса можно найти на веб-узле EIZO.

<http://www.eizoglobal.com>

Informatie over recycling

Wanneer u dit product wilt weggooien, moet het uit milieu-overwegingen worden verzameld en gerecycled volgens de betreffende wetgeving van uw land. Wanneer u dit product wilt weggooien, moet u contact opnemen met een distributeur of een partner in uw land.

De contactadressen worden vermeld op de volgende EIZO-website.

<http://www.eizoglobal.com>

Informação sobre reciclagem

Este produto, quando o deitar fora, deve ser recolhido e reciclado de acordo com a legislação do seu país para reduzir a poluição. Quando deitar fora este produto, contacte um distribuidor ou uma filial no seu país.

Os endereços de contacto estão listados no website do EIZO, abaixo.

<http://www.eizoglobal.com>

Oplysninger om genbrug

Denne produkt forventes ved bortskaffelse at blive indsamlet og genbrugt i overensstemmelse med lovgivningen i dit land for at reducere belastningen af miljøet. Når du bortskaffer denne produkt, skal du kontakte en distributør eller et tilknyttet selskab i dit land.

Adresserne på kontaktpersonerne er angivet på EIZO's websted nedenfor.

<http://www.eizoglobal.com>

Kierrätystä koskevia tietoja

Tuote tulee hävittää kierrättämällä maan lainsäädännön mukaisesti ympäristön kuormittumisen vähentämiseksi. Kun hävität tuotteen, ota yhteyttä jälleenmyyjään tai tytäryhtiöön maassasi.

Yhteystiedot löytyvät EIZOn Internet-sivustolta.

<http://www.eizoglobal.com>

Wykorzystanie surowców wtórnych

Ten produkt po zużyciu powinien być zbierany i przetwarzany zgodnie z krajowymi przepisami dotyczącymi ochrony środowiska. Wyrzucając ten produkt, należy skontaktować się z lokalnym dystrybutorem lub partnerem. Adresy kontaktowe można znaleźć we wskazanej poniżej witrynie internetowej firmy EIZO.

<http://www.eizoglobal.com>

Informace o recyklaci

Při likvidaci produktu musí být produkt vyzvednut a recyklován podle zákonů příslušné země, aby nedocházelo k zatěžování životního prostředí. Zbavujete-li se produktu, kontaktujte distributora nebo pobočku ve své zemi. Kontaktní adresy jsou uvedeny na následující webové stránce společnosti EIZO.
<http://www.eizoglobal.com>

Ringlussevõtu alane teave

Keskkonnakoormuse vähendamiseks tuleks kasutatud tooted kokku koguda ja võtta ringlusse vastavalt teie riigi seadustele. Kui kõrvaldate käesoleva toote, võtke palun ühendust turustaja või filiaaliga oma riigis. Kontaktisikud on toodud EIZO veebilehel järgmisel aadressil:
<http://www.eizoglobal.com>

Újrahasznosítási információ

Jelen terméket, amikor eldobjuk, az illető ország törvényei alapján kell összegyűjteni és újrahasznosítani, hogy csökkentsük a környezet terhelését. Amikor ezt a terméket eldobja, kérjük lépjen kapcsolatba egy országon belüli forgalmazóval vagy társvállalkozással.
A kapcsolat címei az EIZO alábbi weboldalán találhatók felsorolva:
<http://www.eizoglobal.com>

Podatki o recikliranju

Ob koncu uporabe odslužen izdelek izročite na zbirno mesto za recikliranje v skladu z okoljevarstveno zakonodajo vaše države. Prosimo, da se pri odstranjevanju izdelka obrnete na lokalnega distributerja ali podružnico.
Kontaktne naslovi so objavljeni na spodaj navedenih spletnih straneh EIZO:
<http://www.eizoglobal.com>

Informácie o recyklácii

Pri likvidácii musí byť tento výrobok recyklovaný v súlade s legislatívou vašej krajiny, aby sa znížilo zaťaženie životného prostredia. Keď sa chcete zbaviť tohto výrobku, kontaktujte prosím distribútora alebo pobočku vo vašej krajine.
Zoznam kontaktných adries je uvedený na nasledovnej webovej stránke firmy EIZO:
<http://www.eizoglobal.com>

Pārstrādes informācija

Utilizējot šo produktu, tā savākšana un pārstrāde veicama atbilstoši jūsu valsts likumdošanas prasībām attiecībā uz slodzes uz vidi samazināšanu. Lai veiktu šī produkta utilizāciju, sazinieties ar izplatītāju vai pārstāvniecību jūsu valstī.
Kontaktadrese ir norādītas zemāk minētajā EIZO tīmekļa vietnē.
<http://www.eizoglobal.com>

Informacja apie gražinamąjį perdirbimą

Šalinant (išmetant) šiuos gaminius juos reikia surinkti ir perdirbti gražinamuoju būdu pagal jūsų šalies teisės aktus, siekiant sumažinti aplinkos teršimą. Kai reikia išmesti šį gaminį, kreipkitės į jūsų šalyje veikiančią gaminių pardavimo atstovybę arba jos filiaalą.
Kontaktiniai adresatai nurodyti EIZO interneto svetainėje.
<http://www.eizoglobal.com>

Информация относно рециклиране

При изхвърлянето на този продукт се предлага събирането и рециклирането му съобразно законите на вашата страна за да се намали замърсяването на околната среда. Когато искате да се освободите от този продукт, моля свържете се с търговския му представител или със съответните органи отговарящи за това във вашата страна.

Данните за връзка с нас са описани на следния Интернет сайт на EIZO:
<http://www.eizoglobal.com>

Informație referitoare la reciclare

Acest produs, când debarasat, trebuie colectat și reciclat conform legislației țării respective ca să reducem sarcina mediului. Când se debarasează de acest produs, vă rugăm să contactați un distribuitor sau un afiliat al țării respective.

Adresele de contact le găsiți pe pagina de web al EIZO:
<http://www.eizoglobal.com>

معلومات عن إعادة التدوير

عند التخلص من هذا المنتج، من الضروري تجميعه وإعادة تدويره وفقاً للقوانين المتبعة في بلدك لتقليل العبء المسلط على البيئة. عندما تتخلص من هذا المنتج، يرجى الاتصال بموزع أو طرف متناسب إليه في بلدك. عناوين الاتصال مدرجة في موقع ايزو EIZO ادناه على شبكة الانترنت.
<http://www.eizoglobal.com>

Geri Dönüşüm Bilgisi

Bu ürünün, atılacağı zaman, ülkenizin çevre kirliliğinin azaltılması konusundaki mevzuatına göre toplanması ve yeniden değerlendirilmesi gerekmektedir. Ürünü atacağınız zaman lütfen ülkenizdeki bir distribütör veya ilgili kuruluşla temasa geçiniz.

İrtibat adresleri aşağıdaki EIZO web sitesinde verilmiştir.
<http://www.eizoglobal.com>



EIZO Corporation

153 Shimokashiwano, Hakusan, Ishikawa 924-8566 Japan

艺卓显像技术(苏州)有限公司

中国苏州市苏州工业园区展业路 8 号中新科技工业坊 5B

EC REP

EIZO GmbH

Carl-Benz-Straße 3, 76761 Rülzheim, Germany

<http://www.eizoglobal.com>

Copyright © 2016-2019 EIZO Corporation. All rights reserved.



00N0L988D1 
IFU-RX660-6

4th Edition - October 15th, 2019 Printed in Japan.