

OUTLINE DIMENSIONS

MODEL EV2785

UNIT mm

EIZO Corporation

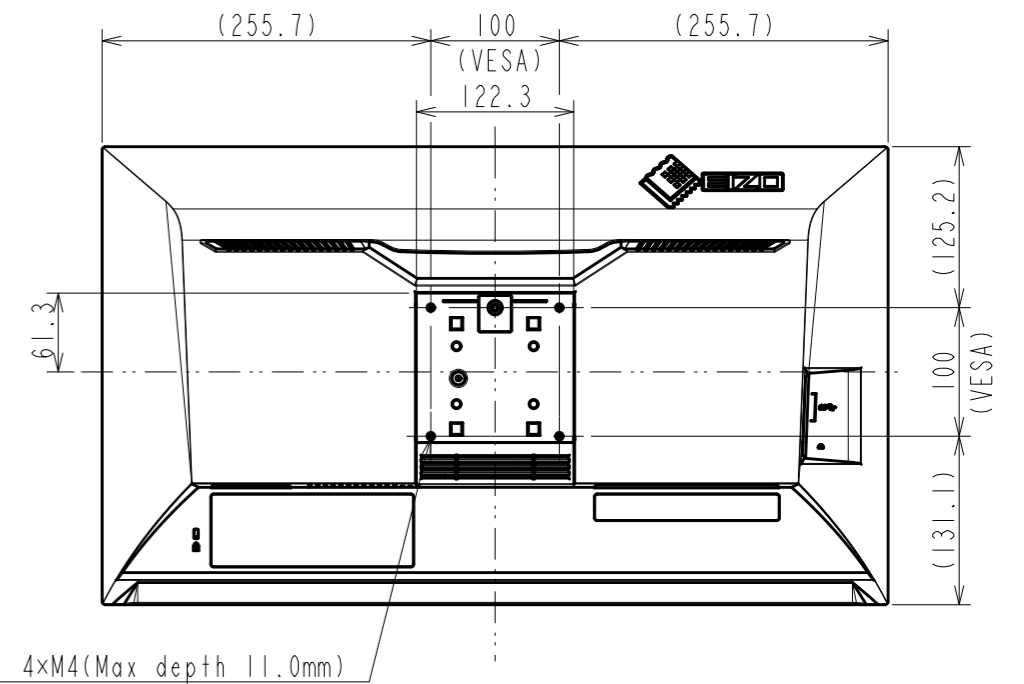
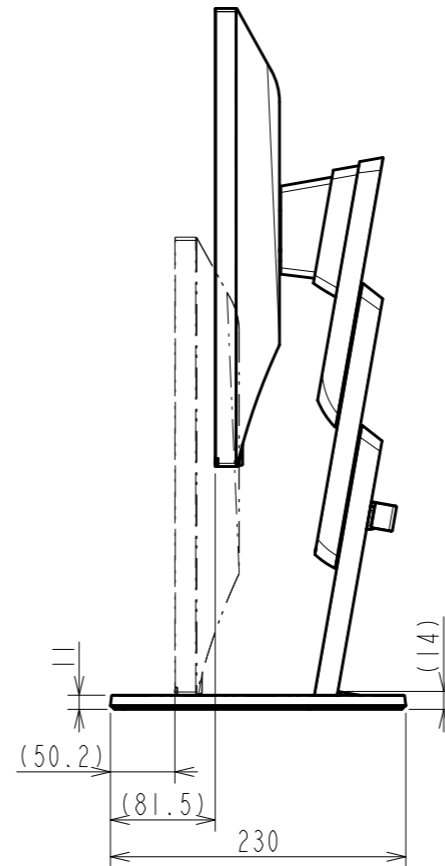
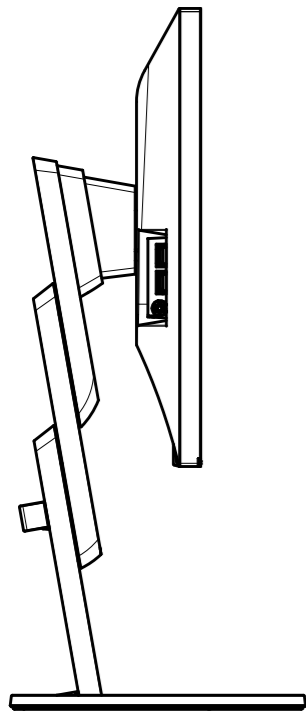
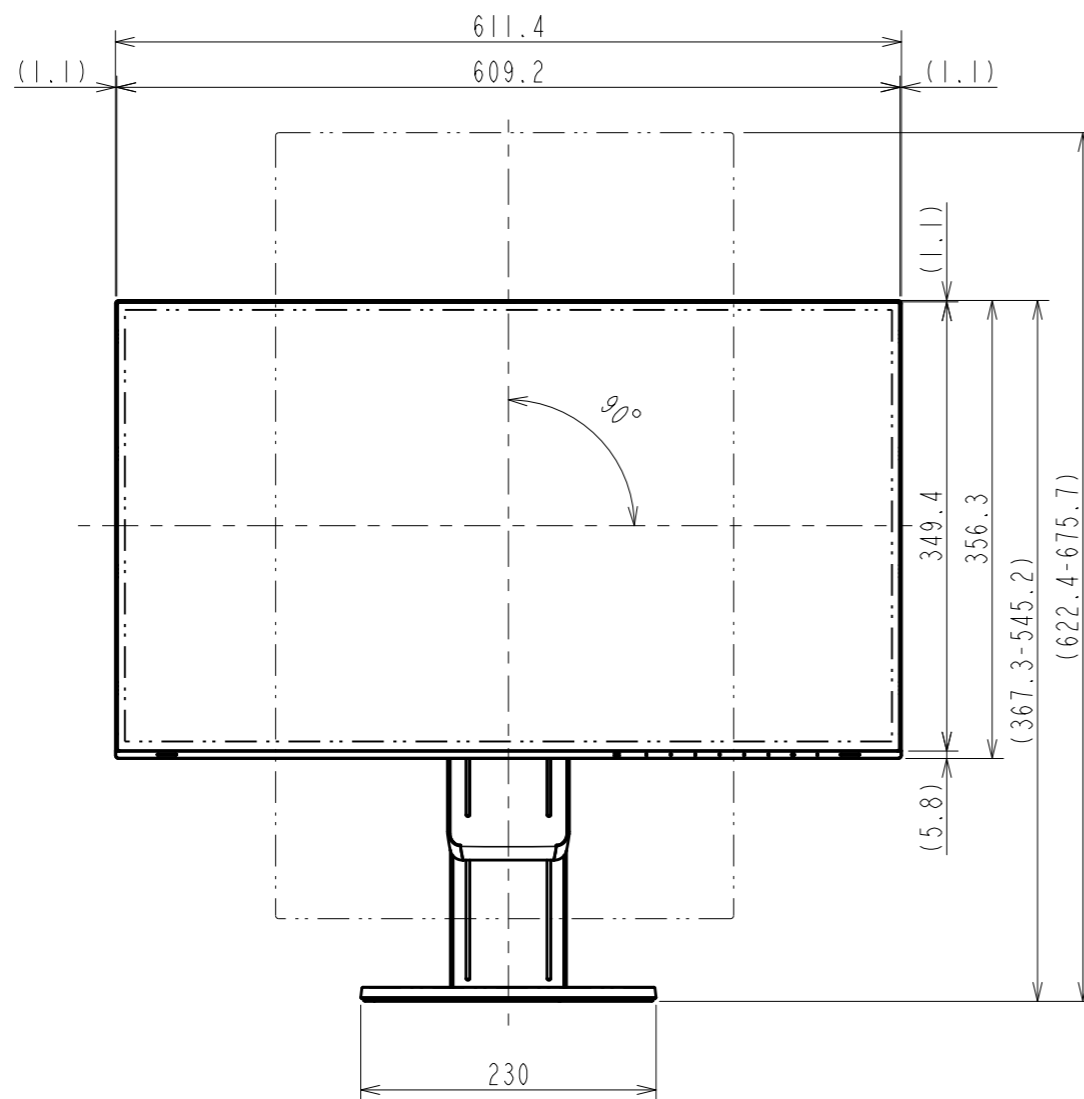
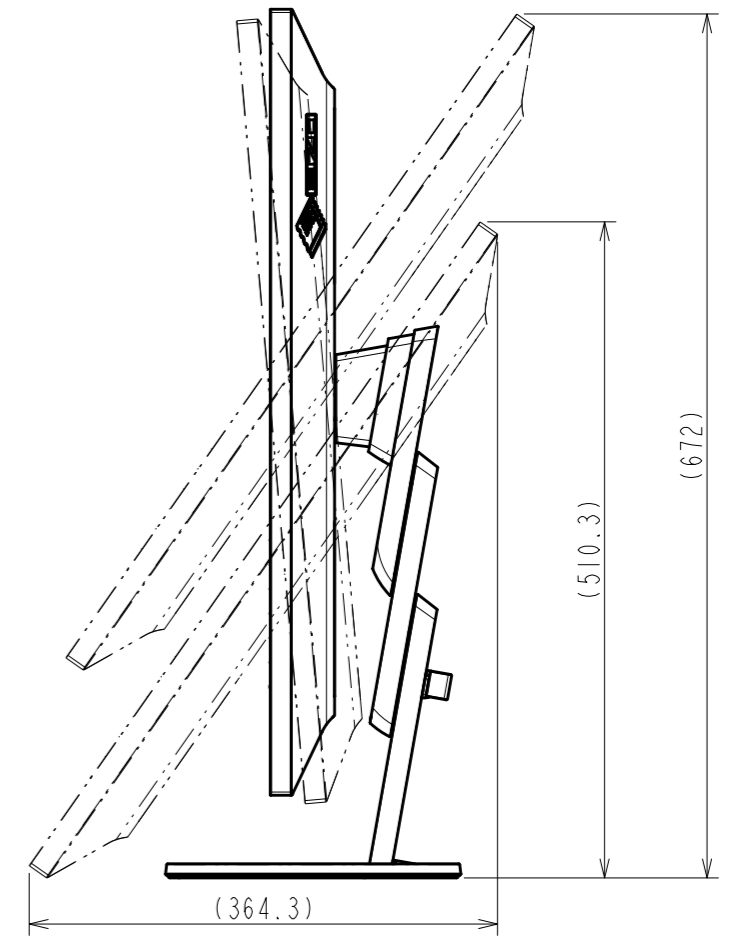
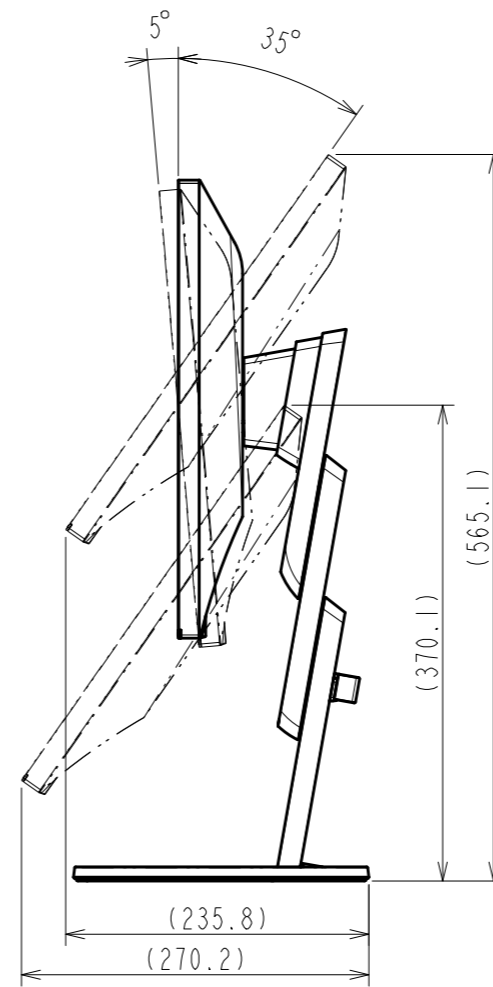
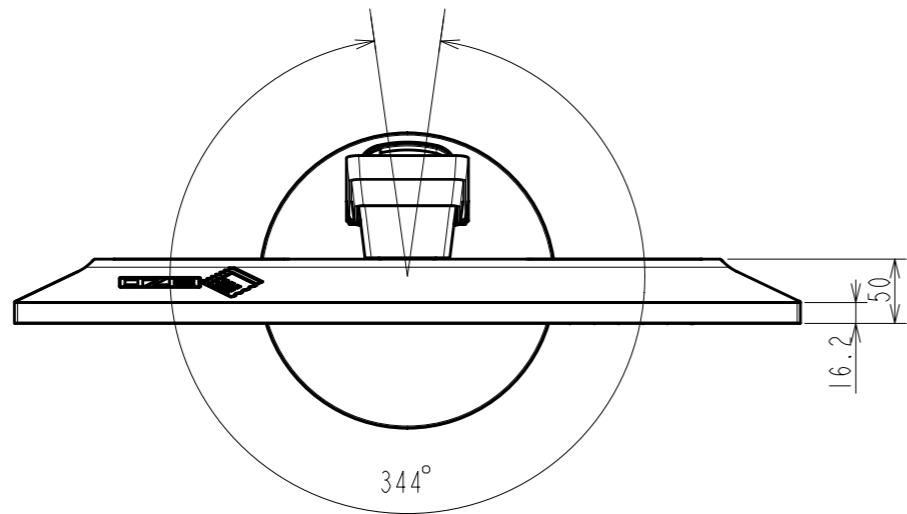

OUTLINE DIMENSIONS

MODEL EV2785

UNIT mm

EIZO Corporation

