

DuraVision® FDF2304W-IP

Color LCD Monitor

English

Deutsch

Français

中文

Setup Manual

Important: Please read this Setup Manual, the Instruction Manual and the Installation Manual carefully to familiarize yourself with safe and effective usage. Please retain this manual for future reference.

• For the latest product information including the User's Manual, refer to our web site: <http://www.eizoglobal.com>

Einrichtungshandbuch

Wichtig: Lesen Sie dieses Einrichtungshandbuch, das Anleitung sowie das Installationshandbuch aufmerksam durch, um sich mit dem sicheren und effizienten Gebrauch vertraut zu machen. Bewahren Sie dieses Handbuch zum späteren Nachschlagen auf.

• Besuchen Sie unsere Website für die neusten Informationen über unser Zubehör, einschließlich des Benutzerhandbuchs:
<http://www.eizoglobal.com>

Manuel de configuration

Important : Veuillez lire attentivement le présent manuel de configuration ainsi que le Manuel d'instructions et le manuel d'installation afin de vous familiariser avec une utilisation sûre et efficace. Veuillez conserver ce manuel pour référence ultérieure.

• Pour obtenir les toutes dernières informations relatives au produit, dont le Manuel d'utilisation, reportez-vous à notre site web:
<http://www.eizoglobal.com>

设置手册

重要事项： 请仔细阅读设置手册、说明手册及安装手册，以便您能了解安全及有效的使用方法。请保留本手册，以备日后参考。

• 访问我们的网页了解包括用户手册在内的最新产品信息：
<http://www.eizoglobal.com>











DuraVision® FDF2304W-IP



Color LCD Monitor

SAFETY SYMBOLS

This manual and this product use the safety symbols below. They denote critical information. Please read them carefully.

 WARNING	Failure to abide by the information in a WARNING may result in serious injury and can be life threatening.
 CAUTION	Failure to abide by the information in a CAUTION may result in moderate injury and/or property or product damage.
	Indicates an attention to be required. For example, the symbol  illustrates the hazard type such as “the risk of electric shock”.
	Indicates a prohibited action. For example, the symbol  illustrates a particular prohibited action such as “Do not disassemble”.
	Indicates a mandatory action that must be followed. For example, the symbol  illustrates the notification of general prohibition such as “Grounding the unit”.

About this manual

	Setup Manual (this manual)	Describes precautions and setup processes from network camera connection to camera image display.
	Instruction Manual *1	Describes operation of network cameras and live image screen menus, etc.
	Installation Manual *1	Describes network camera registration and function setup, monitor system setup, etc.

*1 PDF file on the CD-ROM (Installation of Adobe Acrobat Reader is required.)

This product has been adjusted specifically for use in the region to which it was originally shipped. If operated outside this region, the product may not perform as stated in the specifications.

No part of this manual may be reproduced, stored in a retrieval system, or transmitted, in any form or by any means, electronic, mechanical, or otherwise, without the prior written permission of EIZO Corporation. EIZO Corporation is under no obligation to hold any submitted material or information confidential unless prior arrangements are made pursuant to EIZO Corporation's receipt of said information. Although every effort has been made to ensure that this manual provides up-to-date information, please note that EIZO monitor specifications are subject to change without notice.

PRECAUTIONS

IMPORTANT

To ensure personal safety and proper maintenance, please read carefully this section and the caution statements on the monitor.

Location of the Caution Statements

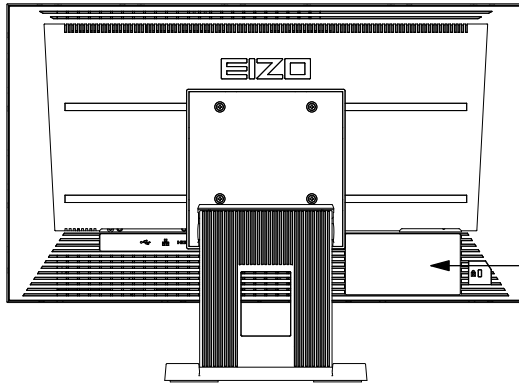



WARNING
RISK OF ELECTRIC SHOCK. DO NOT OPEN.

AVERTISSEMENT
RISQUE DE CHOC ELECTRIQUE. NE PAS OUVRIR.

WARNUNG
GEFAHR DES ELEKTRISCHEN SCHLAGES. RÜCKWAND NICHT ENTFERNEN.

警告
触电危険、请勿打开后盖。

警告
感電の恐れあり、カバーをあげないでください。

The equipment must be connected to a grounded main outlet.
L'appareil doit être relié à une prise avec terre.
Jordet stikkontakt skal benyttes når apparatet tilkobles datanett.
Apparaten skall anslutas till jordat nätuttag.
设备必须连接到接地的电源插座。
電源コードのアースは必ず接地してください。

WARNING

If the unit begins to emit smoke, smells like something is burning, or makes strange noises, disconnect all power connections immediately and contact your local EIZO representative for advice.

Attempting to use a malfunctioning unit may result in fire, electric shock, or equipment damage.

Do not open the cabinet or modify the unit.

Opening the cabinet or modifying the unit may result in fire, electric shock, or burn.



Refer all servicing to qualified service personnel.

Do not attempt to service this product yourself as opening or removing covers may result in fire, electric shock, or equipment damage.

Keep small objects or liquids away from the unit.

Small objects accidentally falling through the ventilation slots into the cabinet or spillage into the cabinet may result in fire, electric shock, or equipment damage. If an object or liquid falls/spills into the cabinet, unplug the unit immediately. Have the unit checked by a qualified service engineer before using it again.



Place the unit at the strong and stable place.

A unit placed on an inadequate surface may fall and result in injury or equipment damage. If the unit falls, disconnect the power immediately and ask your local EIZO representative for advice. Do not continue using a damaged unit. Using a damaged unit may result in fire or electric shock.

WARNING

Use the unit in an appropriate location.

Not doing so may result in fire, electric shock, or equipment damage.

- Do not place outdoors.
- Do not place in a transportation system (ship, aircraft, train, automobile, etc.) where it may be affected by strong vibration or shock.
- Do not place in a dusty or humid environment.
- Do not place in environments with corrosive gases (such as sulfur dioxide, hydrogen sulfide, nitrogen dioxide, chlorine, ammonia, and ozone).
- Do not place in environments with dust, components that accelerate corrosion in the atmosphere (such as sodium chloride and sulfur), conductive metals, and so on.
- Do not place in a location where water is splashed on the screen (bathroom, kitchen, etc.).
- Do not place in a location where the steam comes directly on the screen.
- Do not place near heat generating devices or a humidifier.
- Do not place in a location where the product is subject to direct sunlight.
- Do not place in an inflammable gas environment.



To avoid danger of suffocation, keep the plastic packing bags away from babies and children.

Use the enclosed power cord and connect to the standard power outlet of your country.

Be sure to remain within the rated voltage of the power cord. Not doing so may result in fire or electric shock.

Power supply: 100-120/200-240 Vac 50/60Hz

To disconnect the power cord, grasp the plug firmly and pull.

Tugging on the cord may damage and result in fire or electric shock.

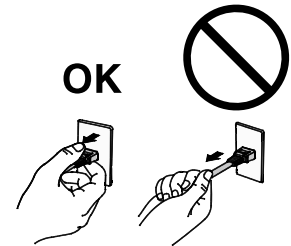

The equipment must be connected to a grounded main outlet.

Failure to do so may result in fire or electric shock.



Use the correct voltage.

- The unit is designed for use with a specific voltage only. Connection to another voltage than specified in this User's Manual may cause fire, electric shock, or equipment damage.
- Do not overload your power circuit, as this may result in fire or electric shock.

Handle the power cord with care.

- Do not place the cord underneath the unit or other heavy objects.
- Do not pull on or tie the cord.

If the power cord becomes damaged, stop using it. Use of a damaged cord may result in fire or electric shock.



Never touch the plug and power cord if it begins to thunder.

Touching them may result in electric shock.



When attaching an arm stand, please refer to the user's manual of the arm stand and install the unit securely.

Otherwise, the unit may become detached, resulting in injury and/or equipment damage. If the unit falls, please ask your local EIZO representative for advice. Do not continue using a damaged unit. Using a damaged unit may result in fire or electric shock. When reattaching the tilt stand, please use the same screws and tighten them securely.

WARNING

Handle the batteries for the remote control with care.

Not doing so may result in battery explosion, liquid leakage, or burns.

- Do not disassemble, heat, short-circuit, or immerse the provided batteries in water.
- Install/change batteries in a correct way.
- When replacing batteries, use ones of the same type and model.
- When replacing batteries, replace all of them at the same time with new batteries of the same brand and type.
- Insert batteries with correct direction of the plus (+) and minus (-) sides.
- Do not use the battery with coating damaged.
- Dispose of your battery in a designated disposal area.

Do not touch a damaged LCD panel directly with bare hands.

The liquid crystal that may leak from the panel is poisonous if it enters the eyes or mouth. If any part of the skin or body comes in direct contact with the panel, please wash thoroughly. If some physical symptoms result, please consult your doctor.



CAUTION

Handle with care when carrying the unit.

Disconnect the power cord and cables when moving the unit. Moving the unit with the cord attached is dangerous. It may result in injury.

When carrying the unit, grasp and hold it firmly by the bottom as shown in the illustration on the right.

Dropping the unit may result in injury or equipment damage.



OK

Do not block the ventilation slots on the cabinet.

- Do not place any objects on the ventilation slots.
- Do not install the unit in a place with poor ventilation or inadequate space.
- Do not use the unit laid down or upside down.

Blocking the ventilation slots prevents proper airflow and may result in fire, electric shock, or equipment damage.



Do not touch the plug with wet hands.

Doing so may result in electrical shock.



Use an easily accessible power outlet.

This will ensure that you can disconnect the power quickly in case of a problem.

Periodically clean the area around the plug.

Dust, water, or oil on the plug may result in fire.

Unplug the unit before cleaning it.

Cleaning the unit while it is plugged into a power outlet may result in electric shock.

If you plan to leave the unit unused for an extended period, disconnect the power cord from the wall socket after turning off the power for safety and power conservation.

CONTENTS

PRECAUTIONS	2
IMPORTANT	2
CONTENTS	5
Package Contents	6
Monitor	7
Remote Control	8
Setup	9
Connect the network camera(s)	10
Prepare the remote control	11
Turning On the Power	12
Configuring the Language	16
Perform Easy Setup	17
Reference	23
● How to Attach the Optional Arm	23
● Connecting HDMI Devices	24
● Specifications	26
● Display capability	27
● Outline Dimensions	27
Appendix	28
FCC Declaration of Conformity	28

Package Contents

Check that all of the following parts are included. If any are missing, or damaged, contact your dealer or our customer support listed in a separate document.

- Monitor

- Power cord

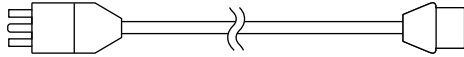

- HDMI cable (HH200HS)

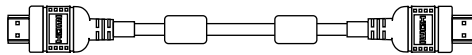

- Remote control

- AA batteries (2 pcs)

- Setup Manual (this manual)

- EIZO User's Manual (CD-ROM)

Note

- Please keep the packaging box and materials for future movement or transport of the monitor.
-

Monitor

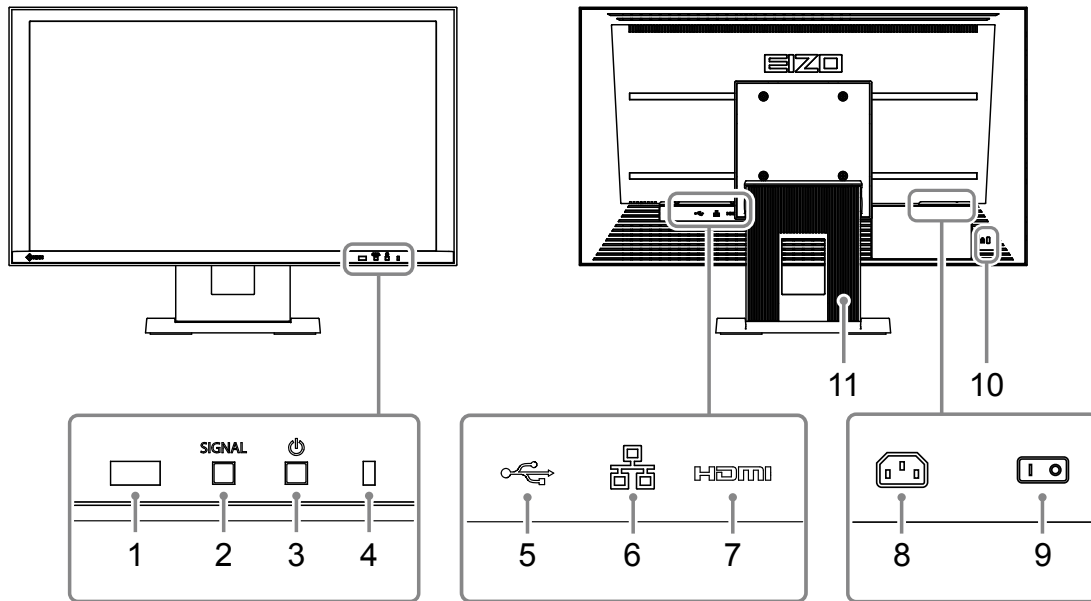

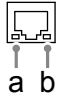
Name	Description			
1. Remote control detector	Receives signals from the remote control.			
2. SIGNAL button	Switches input signals for display.			
3. ⏻ button	Turns the power on or off.			
4. Power Indicator	Indicates the monitor's operation status.			
	Blue:	Operating		
	Flashing blue:	Shutting off the system		
	Red:	Power off (With "Quick Start" to "On"*1)		
5. USB downstream port	Connects a USB mouse or storage devices such as a USB flash drive.*2			
6. LAN port	Connects the network cable.			
		a) Link LED	Green:	Network connection established
			OFF:	Network connection disabled
	b) Status LED	Flashing orange:	Data transfer is in progress	
7. HDMI connector	Connects external devices that support HDMI.			
8. Power connector	Connects the power cord.			
9. Main power switch	Turns the main power on or off. : On O : Off			
10. Security lock slot	Complies with Kensington's MicroSaver security system.			
11. Stand*3	Used to adjust the angle of the monitor screen.			

*1 The power-off status can be set with "Quick Start". For details, refer to the Installation Manual.

*2 Other USB devices (such as USB keyboards or USB hubs) cannot be connected.

*3 An optional arm (or an optional stand) can be attached by removing the stand section. Refer to "How to Attach the Optional Arm" (page 23) for details on how to mount the arm.

Remote Control

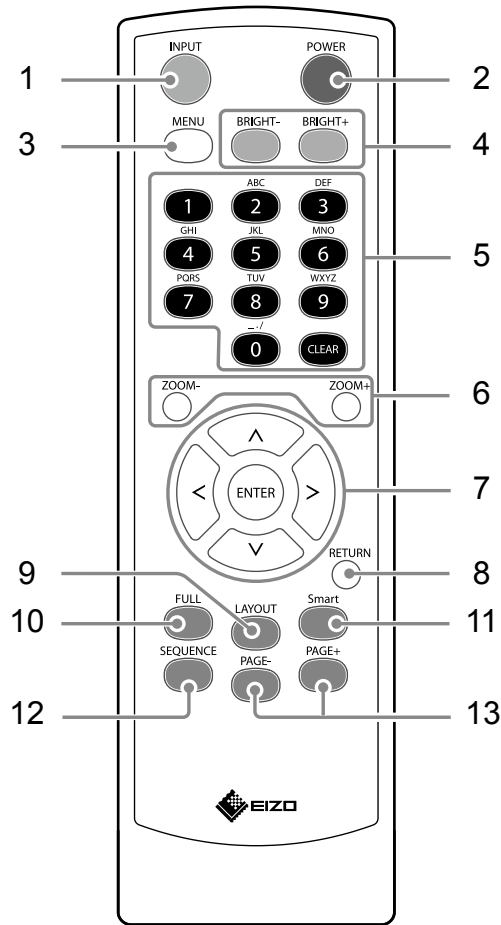

Name	Description
1. INPUT	Switches input signals for display.
2. POWER	Turns the power on or off.
3. MENU	Used to display/exit the monitor's Adjustment menu.
4. BRIGHT- / BRIGHT+	Adjusts the brightness of the monitor screen.
5. Number Buttons (0 to 9) / CLEAR	Used to enter numbers and letters.
6. ZOOM- / ZOOM+	Adjusts the network camera display magnification.
7. $\wedge / \vee / < / >$, ENTER	Used to set and control (pan / tilt) network cameras, and configure system settings of the monitor.
8. RETURN	Returns to the previous menu status in menu operation.
9. LAYOUT	Changes the live image screen layout. Each time the button is pressed, the layout changes in the following order: 1 Screen → 3 Screens → 4 Screens → 9 Screens → 16 Screens → 8 Screens → 1 Screen.
10. FULL	Displays / hides the menu of the live image screen.
11. Smart	Turns the Smart function on or off.
12. SEQUENCE	Turns the sequential display of camera images on or off.
13. PAGE- / PAGE+	Changes the camera image page to display on the live image screen.

Setup

Sets up to displaying network camera images on the monitor.

You can operate and set the monitor by using either the remote control or a USB mouse.

For details, refer to the corresponding pages.

Setup Flow

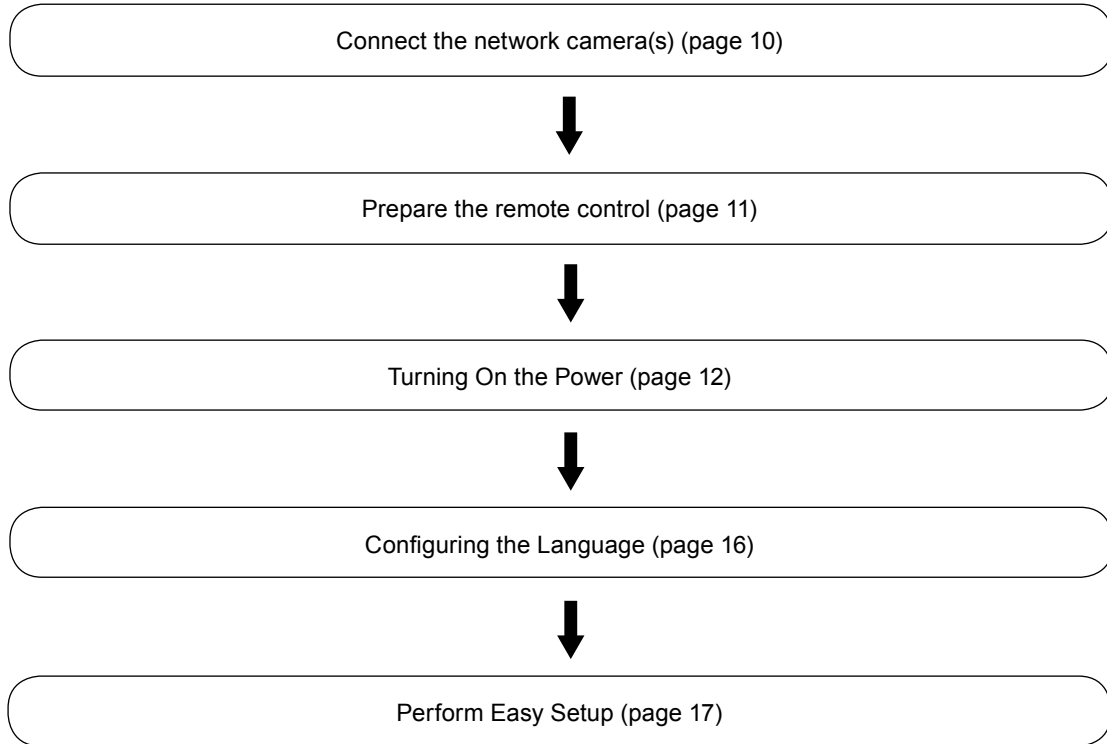

Set the following items using the setup wizard.

- Date and time on the monitor
- Monitor network information
- Automatic discovery of network cameras
- Display positions of camera images

Setup completed.

Images from the network camera(s) are displayed on the monitor.

Attention

- The language used in menus and messages displayed when the monitor is started differs according to the sales region.
- When using the Easy Setup function, only the network cameras installed in the same subnet as the monitor are detected. If a network camera is installed in a different subnet, the camera must be registered manually (For more information, refer to the Installation Manual (“Chapter2 Configuring from the Monitor Screen”).)

Note

- When using a USB mouse to operate the menu
 - Connect the mouse to the USB downstream port at the back of the monitor.

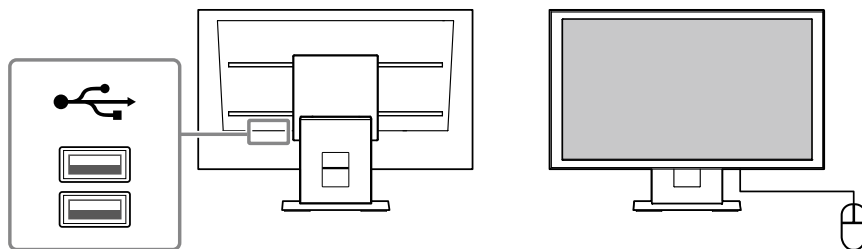

Connect the network camera(s)

Connect the network camera and the monitor according to the following procedure.

1. Connect the network camera to the monitor via the network hub.

1. Connect the network cable (straight cable, Cat 5e or higher) to the monitor and the LAN port of the network hub.

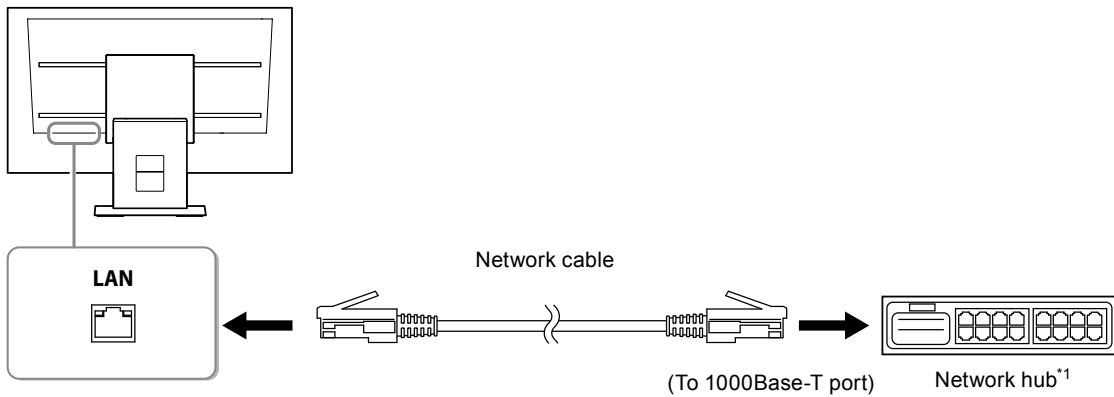

*1 Use a hub compatible with 1000Base-T. For some network cameras, the hub must be compatible with the PoE function. Check the network camera's manual for information on the appropriate hub to use.

2. Connect the network camera to the network hub.

For connecting the network camera and the network hub, refer to the network camera's manual.

Connection examples

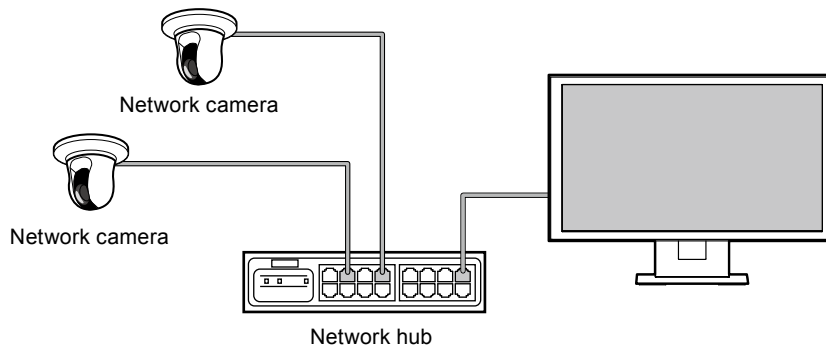

Note

- A maximum of 16 network cameras can be connected.

2. Plug the power cord into a power outlet and the power connector on the monitor.

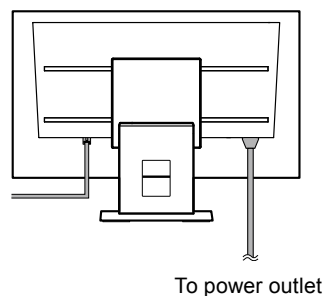

Attention

- Do not bundle cables when wiring.
- The main power switch is turned on when factory default settings are configured.

Prepare the remote control

Insert batteries into the remote control. The remote control is used for operating and configuring this monitor.

1. On the back of the remote control, press the knob to unlock, and remove the cover.

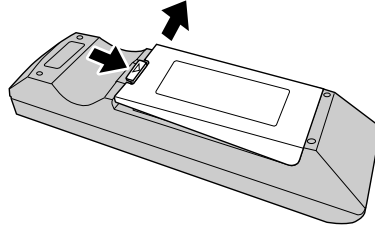

2. Input AA batteries, and slide the cover back.

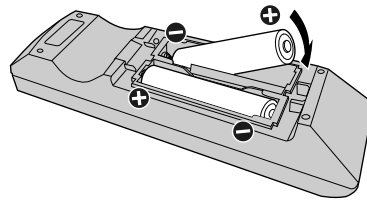

Attention

- Use the remote control within the range illustrated in the diagram below.

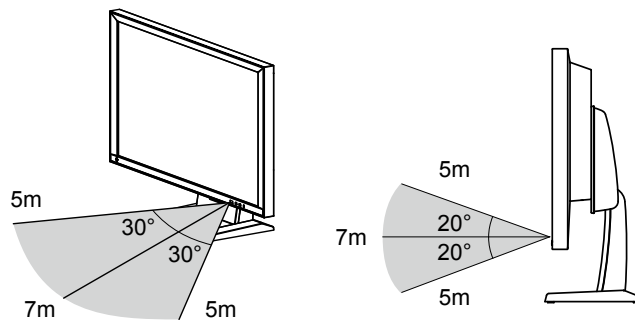

- When installing multiple monitors, leave sufficient space between each monitor so that only the intended monitor will be operated by the remote control. Otherwise, all monitors that receive the remote control signal will operate accordingly.
-

Turning On the Power

1. Turn on the main power switch on the back of the monitor.

The main power switch is turned on when factory default settings are configured.

2. Press on the front of the monitor or POWER on the remote control.

The power indicator lights up blue and the live image screen is displayed. For details on the live image screen, refer to the Instruction Manual.

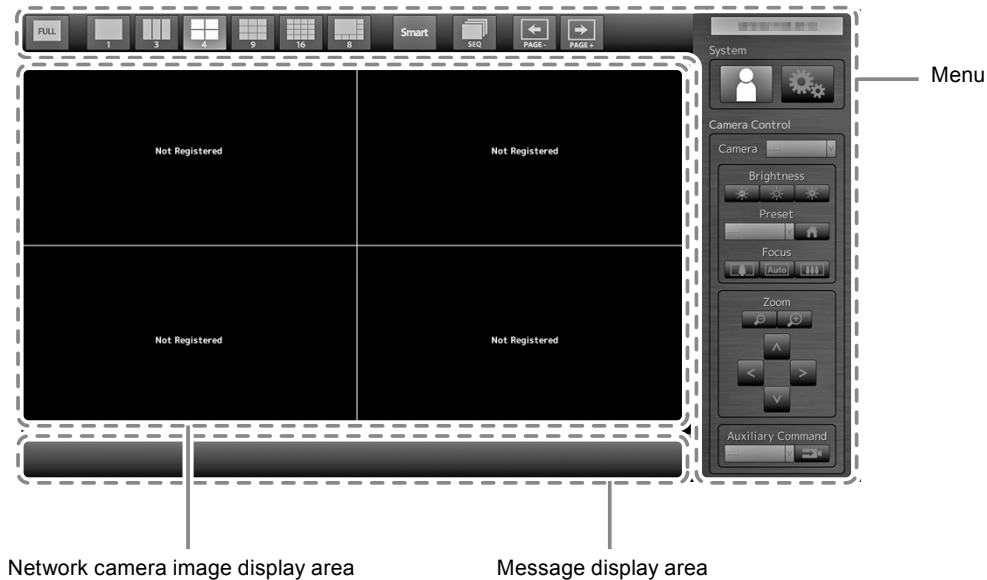

Attention

- By default, it takes approximately one minute for the live image screen to be displayed after the power is turned on (A rotating bar indicating startup is displayed). Do not turn off the monitor during startup.
- When the monitor is started up for the first time, a menu for operating the monitor and network cameras is displayed.
- When no network camera is registered, a “Not Registered” message is displayed at the network camera image display area.

Note

- The time required to display the live image screen can be reduced (Quick Start) by changing the power-off status. For details, refer to the Installation Manual.
- Press  on the front of the monitor or POWER on the remote control to turn off the power.

Menu Operations



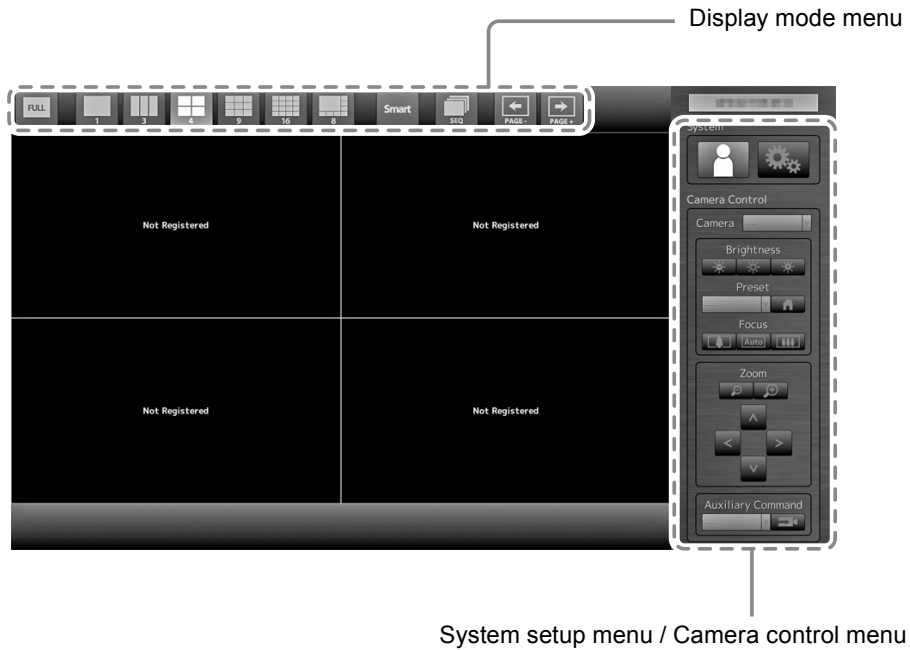

Each menu is operated using the remote control or a USB mouse.

If the menu is not displayed, press FULL on the remote control, or click the screen with the USB mouse to display the menu.

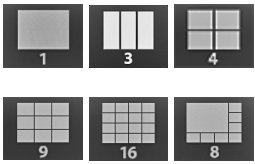

Display mode menu

Camera images displayed on the live screen can be operated.

Display mode menu	Remote control button	Description
	FULL	Displays / hides the menu of the live image display screen.
	LAYOUT	Changes the live image screen layout. Each time the button is pressed, the layout changes in the following order: 1 Screen → 3 Screens → 4 Screens → 9 Screens → 16 Screens → 8 Screens → 1 Screen.
	Smart	Turns the Smart function* ¹ on or off. * ¹ Improves the image visibility.
	SEQUENCE	Turns the sequential display* ² of camera images on or off. * ² Changes over the displayed page at a set interval.
	PAGE- / PAGE+	Changes the camera image page to display on the live image screen.

System setup menu / Camera control menu

The system settings menu is used for logging into and configuring the system. The camera control menu controls network cameras from the monitor in the camera operation menu.

Item	Description
To select an item	Press the \wedge / \vee / \lt / \gt buttons.
To confirm a selected item	Press ENTER.
To change a setting	With setting buttons: Press ENTER (Excluding zoom in/out and position adjustment). With list box: <ol style="list-style-type: none">1. Press ENTER. The list box is highlighted in green.2. Select the setting with \wedge or \vee.3. Press ENTER.
To return to the previous menu level	Press RETURN. Note <ul style="list-style-type: none">• When canceling a setting change in process, press RETURN.
To exit the setting screen	<ol style="list-style-type: none">1. Select "Exit" from the list of setting items with \vee.2. Press ENTER.

3. Check that (Login) is selected and press ENTER.

The login screen is displayed.

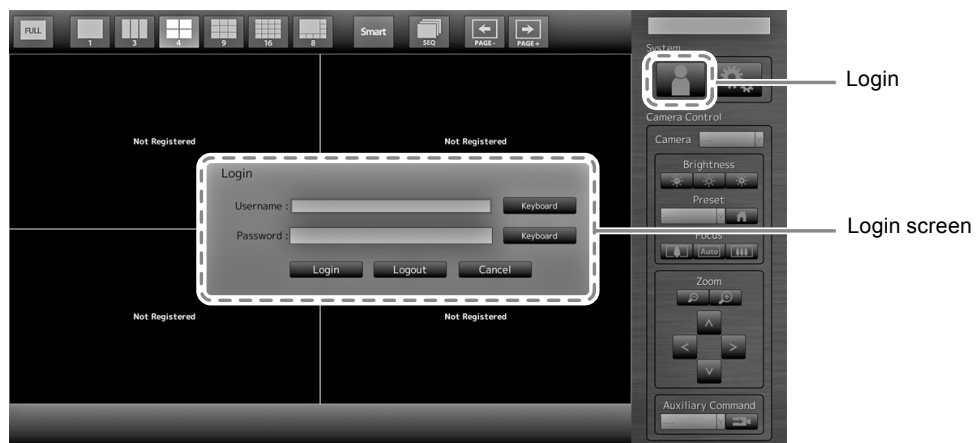

Note

- The currently selected item is lit up in green.

4. Enter the "Username" and the "Password".

1. Select a text field and press ENTER.
The text field is highlighted in green.
2. Enter the username or password shown below and then press ENTER.
Username: "admin"
Password: "admin"

Note

- The above username and password are default settings.

Entering characters

1. Press ENTER.

The text field is highlighted in green.

2. Press the number buttons (0 to 9).

Press a button consecutively to change over to the character next in order. For the order of character entry, refer to the table shown below.

Button	Input characters									
0	0	-	_	:	.	/	(space)			
1	1									
2	a	b	c	A	B	C	2			
3	d	e	f	D	E	F	3			
4	g	h	i	G	H	I	4			
5	j	k	l	J	K	L	5			
6	m	n	o	M	N	O	6			
7	p	q	r	s	P	Q	R	S	7	
8	t	u	v	T	U	V	8			
9	w	x	y	z	W	X	Y	Z	9	

To enter a new character, press >.

To delete a character, press CLEAR.

3. Press ENTER.

Note

- Entering network addresses
Network address text fields are separated by [.] (a period mark).
 - When a three-digit number is entered, the cursor automatically moves to the next entry position.
 - When entering a two-digit or one-digit number, press > to move to the next entry position.
- When using a USB mouse:
 - When you enter a period ".", the cursor moves to the next entry position.
 - To enter characters, click "Keyboard" on the character entry screen. Then click the keys on the displayed keyboard to enter characters.

Attention

- The remote control cannot be used to select the character entry screen keyboard.

5. Select "Login" and press ENTER.

The screen returns to the live image screen and  (Setup) becomes available.

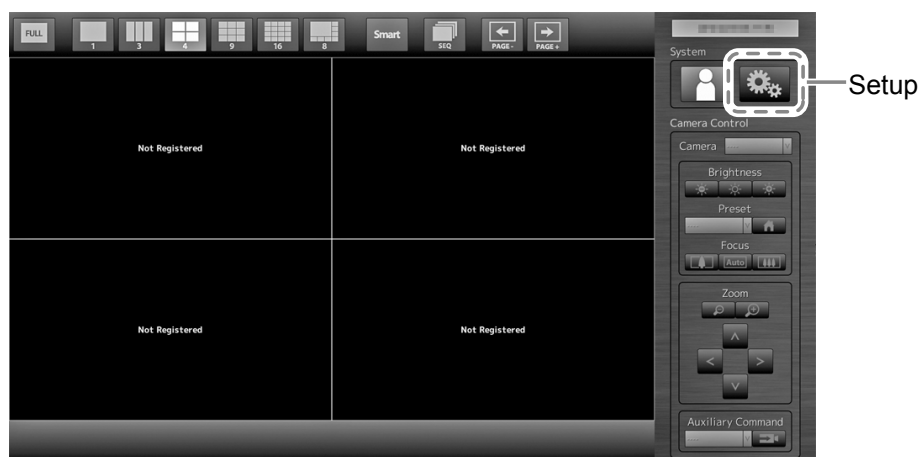

6. Select (Setup) and press ENTER.

The setup screen is displayed.

Configuring the Language

Set the display language for the live screen menu and the setting screen from the setting menu.

1. Check that “System” is selected and press ENTER.

2. Select “Other” and press ENTER.

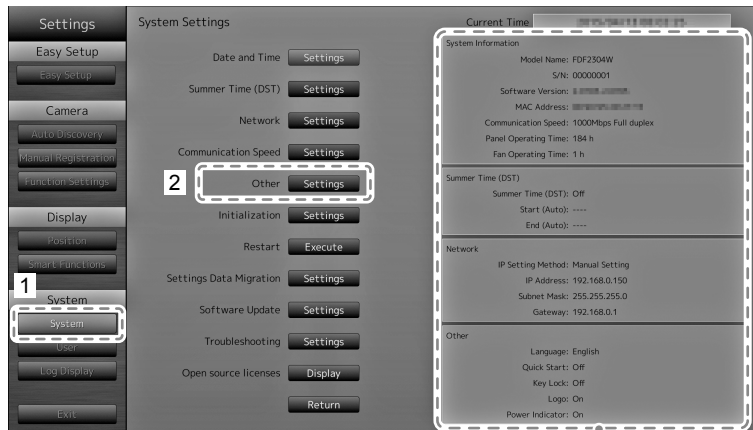

Displays current settings.

3. Select “Language” and press ENTER.

Select the list box and press ENTER. Select a language using \wedge or \vee the press ENTER.

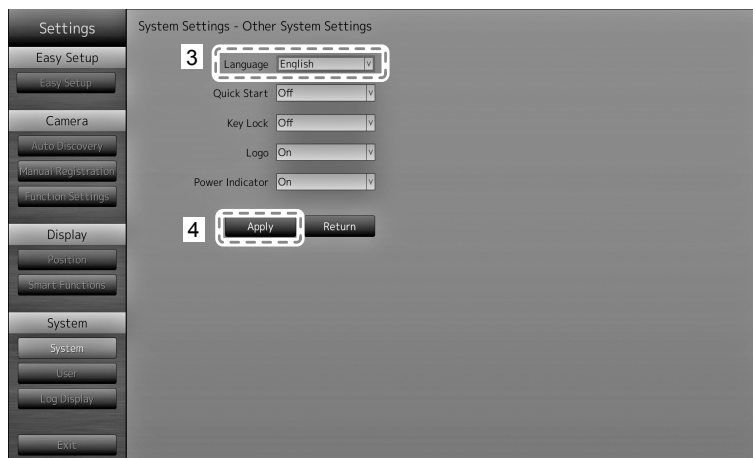

4. Select “Apply” and press ENTER.

The setting complete screen is displayed. Press “OK”.

5. press RETURN.

Perform Easy Setup

Necessary settings for displaying network camera images on the monitor.

1. Start up the network camera(s).

For network camera setup, refer to the network camera's manual.

Attention

- Connect cameras other Panasonic or AXIS network cameras using ONVIF. Check if ONVIF is enabled in the settings of the camera.

2. Check that “Easy Setup” is selected and press ENTER.

3. Check that “Start” is selected and press ENTER.

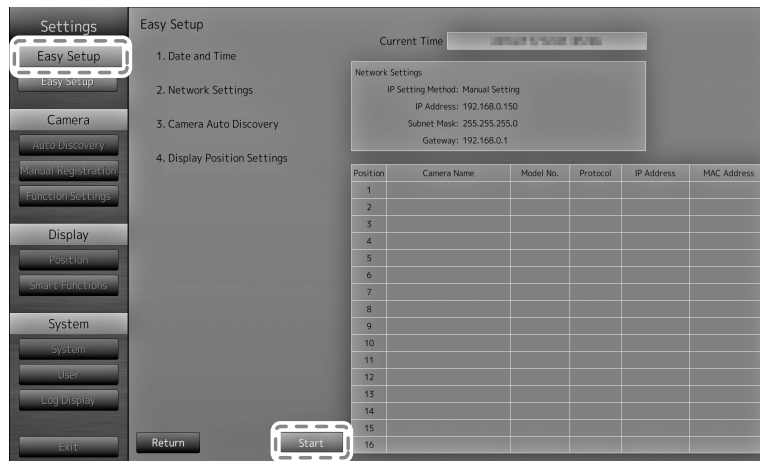

The Easy Setup wizard starts and the date/time setup screen is displayed.

4. Set the date and time on the monitor.

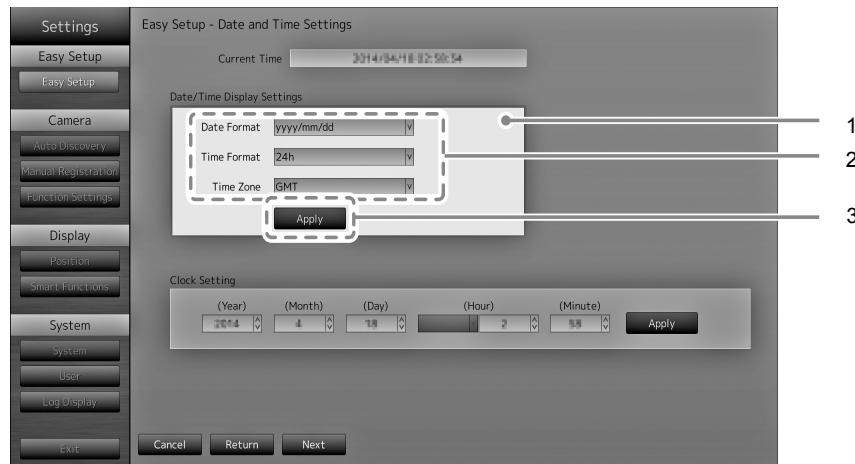

1. Select “Date/Time Display Settings” and press ENTER.
2. Set the “Date Format”, “Time Format” and “Time Zone”.
Select the list box of an item and press ENTER.
Select a setting with \wedge or \vee and press ENTER.
3. After completing the setting, select “Apply” and press ENTER.
The setting complete screen is displayed. Press ENTER to select “OK”.
4. Press RETURN.

5. Select “Clock Setting” using \wedge or \vee , then press ENTER.

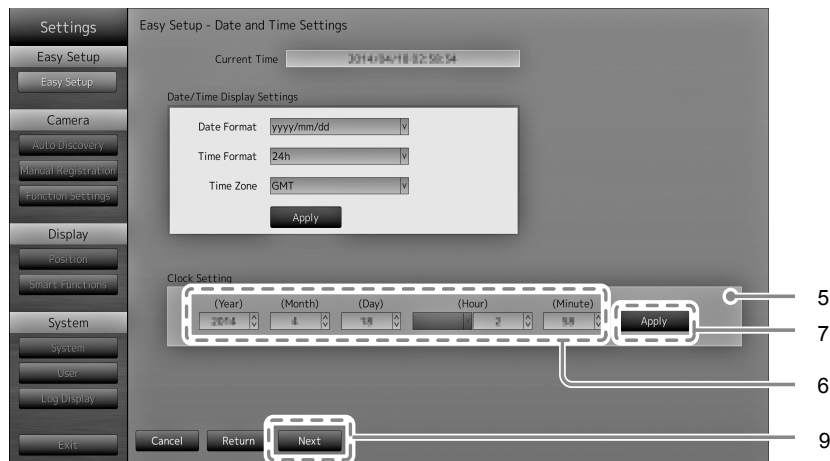

6. Set the “Year”, “Month”, “Day”, “Hour”,and “Minute”.
Select the list box of an item and press ENTER.
Select a setting with \wedge or \vee and press ENTER.
7. After completing the setting, select “Apply” and press ENTER.
The setting complete screen is displayed. Press ENTER to select “OK”.
8. Press RETURN.
9. Select “Next” and press ENTER.
The network settings screen is displayed.

5. Set monitor network information.

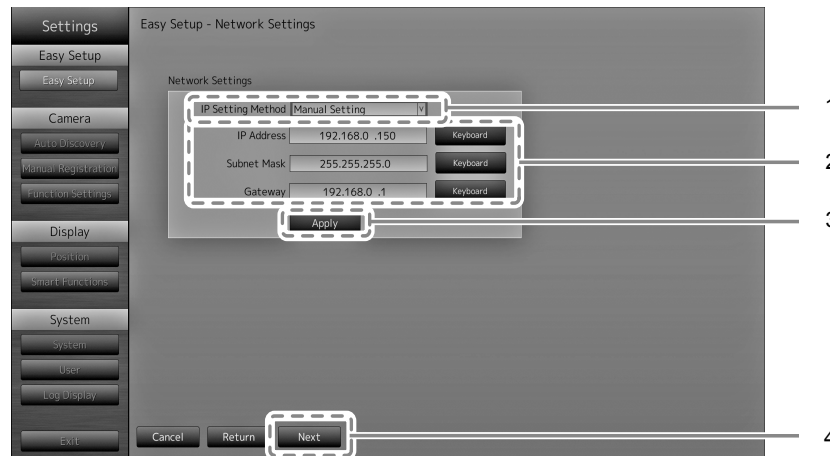

1. Check that “IP Setting Method” is selected and press ENTER.
Select a setting with \wedge or \vee and press ENTER.
If you selected “Manual Setting”, proceed to step 2.
If you selected “DHCP”, proceed to step 3.
2. Set the “IP Address”, “Subnet Mask” and “Gateway”.
Select the list box of an item and press ENTER.
Input the respective values. For details on the data entry method, refer to “Entering characters” (page 15).

Attention

- If your network environment does not include a gateway, you do not need to set the “Gateway” address. Use the default setting as is, or set as “0.0.0.0”.

3. After completing the setting, select “Apply” and press ENTER.
The setting complete screen is displayed. Press ENTER to select “OK”.
4. Select “Next” and press ENTER.
The network camera automatic discovery screen is displayed.

6. Automatically discover network cameras.

1. Select “Camera Discovery”, then press ENTER.
2. Select the camera type using \wedge or \vee , then press ENTER.



3. Check that “Start” is selected and press ENTER.
The user authentication screen is displayed.

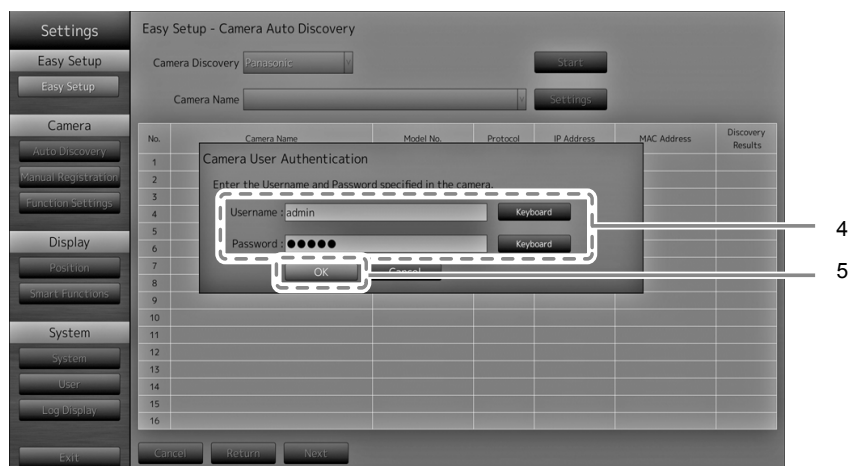

4. Enter the “Username” and “Password” specified in the network camera.
The following values are entered as the default settings. Change the settings if necessary.
Please contact your administrator for the username and password.
 - Username: “admin”
 - Password: “12345”

5. Select “OK” and press ENTER.

Automatic discovery is started and a “Searching” message is displayed.

Information on discovered network cameras are displayed.

The network camera discovery results are displayed.

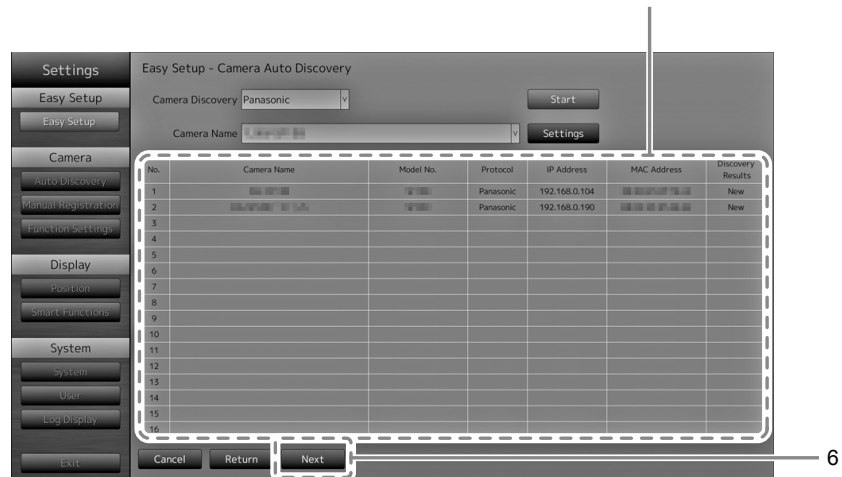

Discovery Results	Description
Blank	When there is no information update for the registered network cameras, or one is not connected
New	When there is an unregistered network camera, or information was updated for a registered network camera
Duplicate	When there is a network camera with a duplicate IP address

6. After the search is completed, select “Next” and press ENTER.

The network camera display position settings screen is displayed.

Note

- The displayed camera name is the name set on the camera side. If cameras have identical names, they are automatically numbered (e.g. camera_1).
- When network cameras are not automatically detected, see “Chapter 4 Troubleshooting” in the Installation Manual.
- When using an AXIS network camera
 - When executing automatic detection with an incorrect user name or password, “-----” is displayed for the model name.
 - When a detected IP address is a duplicate of a registered network camera, but the username and password are correct, ‘Model Name – MAC Address’ is displayed, and ‘-----’ is displayed for the model name.

7. Set the positions for displaying the network camera images.

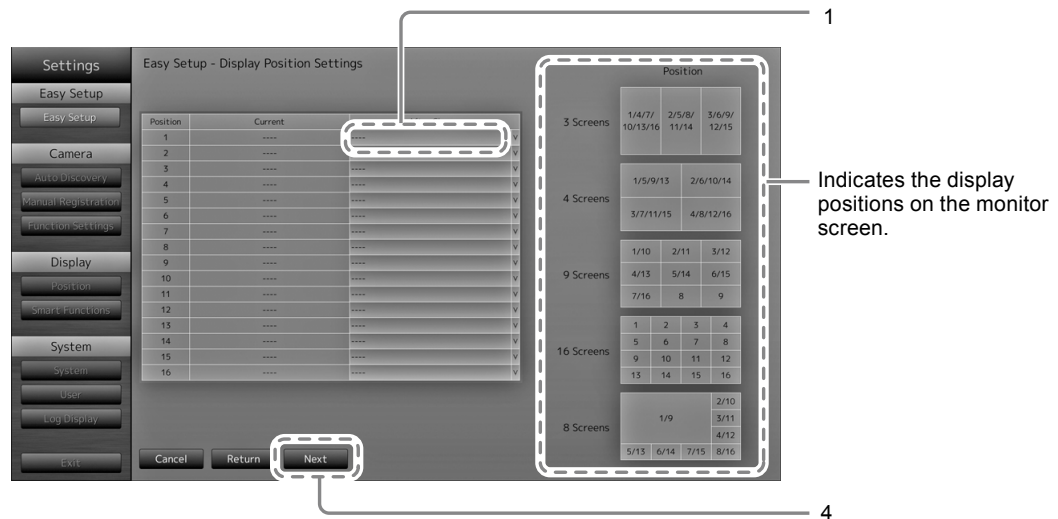

1. Press ENTER.
The "After Change" list box is selected.
2. Set a network camera to a position for displaying images.
Select the list box of a display position you wish to set and press ENTER.
Select a network camera with \wedge or \vee and press ENTER.
3. After completing the setting, press RETURN.
4. Select "Next" and press ENTER.

Attention

- All cameras discovered at step 6 must be set. A network camera can only be set for one display position. When there are incorrect settings, "Next" cannot be selected.

8. Finish Easy Setup.

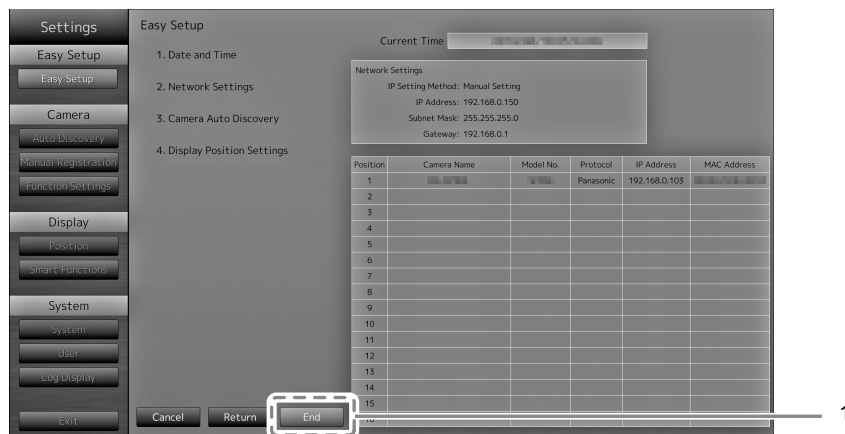

1. Check that "End" is selected and press ENTER.
The setting complete screen is displayed. Press ENTER to select "OK".

Easy Setup is completed.

9. Close the setup screen.

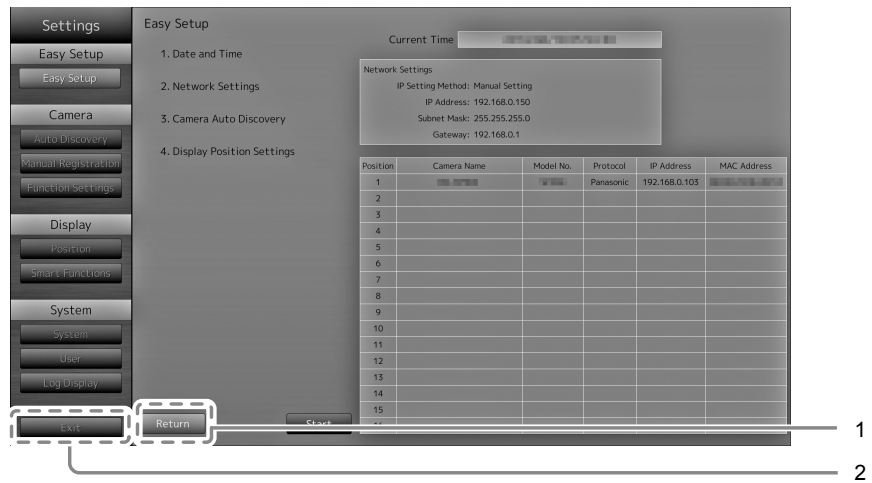

1. Select “Return” and press ENTER.

2. Select “Exit” and press ENTER.

The screen returns to the live image screen.

Check that images from the network camera(s) are displayed on the monitor.

(Example)



Reference

● How to Attach the Optional Arm

An optional arm (or an optional stand) can be attached by removing the stand section. Please refer to our web site (<http://www.eizoglobal.com>) for the corresponding optional arm (or optional stand).

Attention

- When attaching an arm or stand, follow the instructions of their user's manual.
- When using another manufacturer's arm or stand, confirm the following in advance and select one conforming to the VESA standard. Use the screws securing the unit and the stand.
 - Clearance between the screw holes: 100 mm × 100 mm
 - Thickness of plate: 2.6 mm
 - Strong enough to support weight of the monitor unit (except the stand) and attachments such as cables.
- When using an arm or stand, attach it to meet the following tilt angles of the monitor.
 - Up 45°, down 45°
- Do not turn the monitor in the vertical direction.
- Connect the cables after attaching an arm or stand.
- The monitor and arm or stand are heavy. Dropping them may result in injury or equipment damage.
- Periodically check the tightening of screws. If screws are loose, the monitor may detach and cause injury or equipment damage.

Procedure

1. Lay the LCD monitor on a soft cloth spread over on a stable surface with the panel surface facing down.

2. Remove the stand.

Prepare a screwdriver. Loosen the screws (four) securing the unit and the stand with the screwdriver.

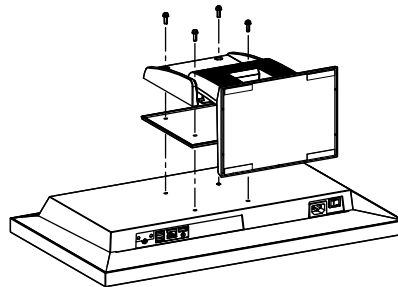

3. Attach the arm or stand to the monitor.

Secure the monitor to the arm or stand using the screws specified in the user's manual of the arm or stand.

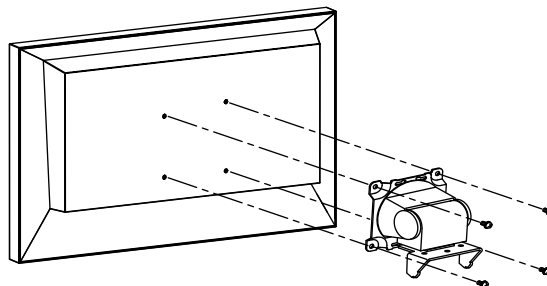

● Connecting HDMI Devices

Connect an HDMI device to this product to switch over the network camera display to the HDMI device.

Connection examples

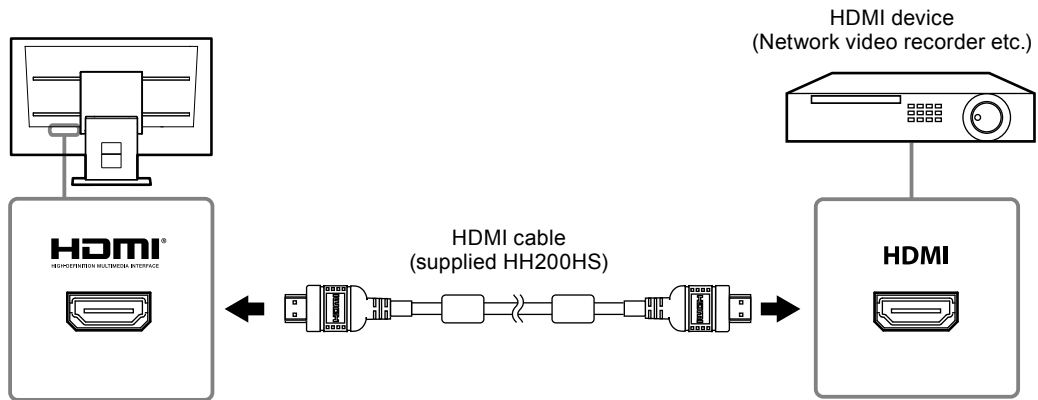

Compatible Resolutions / Formats

The monitor supports the following resolutions and signal format.

PC Signal

Resolution	Applicable Signals	Vertical Scan Frequency	Dot Clock
640 × 480	VGA, CEA-861	60 Hz	148.5 MHz (Max.)
720 × 400	VGA TEXT	70 Hz	
720 × 480 (4 : 3)	CEA-861	60 Hz	
720 × 480 (16 : 9)	CEA-861	60 Hz	
720 × 576 (4 : 3)	CEA-861	50 Hz	
720 × 576 (16 : 9)	CEA-861	50 Hz	
800 × 600	VESA	60 Hz	
1024 × 768	VESA	60 Hz	
1280 × 720	CEA-861	60 Hz	
1280 × 960	VESA	60 Hz	
1280 × 1024	VESA	60 Hz	
1680 × 1050	VESA CVT, VESA CVT RB	60 Hz	
1920 × 1080 ^{*1}	CEA-861	60 Hz	

*1 Recommended resolution

Video Signal

- 480p / 720p / 1080p: 60 Hz
- 576p / 720p / 1080p: 50Hz

To switch among input signals

Press INPUT on the remote control to change over the input signal.

When the signal is switched, the active input port name appears at the top right corner of the screen.

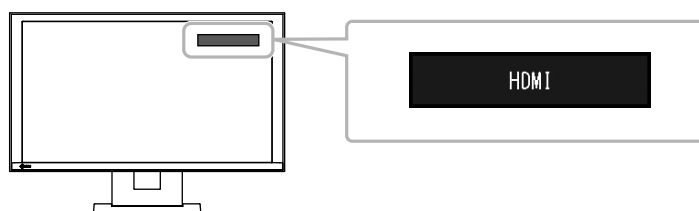

Note

- SIGNAL on the monitor also can change the input.

Adjusting screen brightness

Adjust the brightness of the monitor screen by changing the brightness of the backlight (light source at the back of the LCD panel).

Adjustable range

0 to 100

Procedure

1. Press BRIGHT- or BRIGHT+ on the remote control.
The brightness adjustment menu is displayed.



2. Set the brightness with BRIGHT- or BRIGHT+.
The menu disappears automatically after approximately five seconds.

Specifying color space

The color space of the input signal can be specified. Change the settings when colors are not displayed accurately.

Attention

- “Auto” cannot be selected during PC signal input.

Adjustable range

Auto, YUV 4:2:2, YUV 4:4:4, RGB Full Range, RGB Limited Range

Procedure

1. Press MENU on the remote control.
The Adjustment menu is displayed.

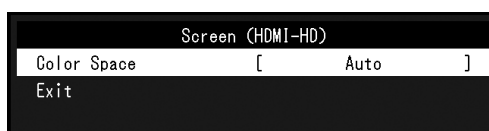

2. Select “Color Space” with \wedge or \vee and press ENTER.
3. Use \wedge or \vee for adjustment.

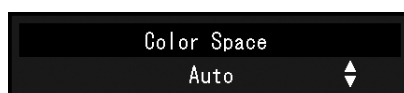

4. Press ENTER.
5. Press MENU to exit the Adjustment menu.

● Specifications

LCD Panel	Type	IPS
	Backlight	LED
	Size	58 cm (23.0 inch) (58.4 cm diagonal)
	Native resolution	1920 dots × 1080 lines
	Display size (H x V)	509.1 mm × 286.4 mm
	Pixel pitch	0.2652 mm
	Display colors	8-bit colors : 16.77 million colors
	Viewing angles (H / V, typical)	178° / 178°
	Contrast ratio (typical)	1000 : 1
	Response time (typical)	Approx. 16 ms (black - white - black) Approx. 8 ms (gray-to-gray)
LAN	Standard	IEEE802.3ab (1000BASE-T), IEEE802.3u (100BASE-TX)
	Communication speed	1000 Mbps, 100 Mbps
	Protocols	TCP/IP
	IP version	4
Video signal (network)	Terminal	RJ-45
	Video compression format	H.264, MJPEG
	Maximum resolution	H.264 : 1920 × 1080*1 MJPEG : 640 × 480
	Maximum frame rate	30 fps
	Maximum bit rate	8192 kbps
	Number of displayed network cameras	Max. 16 units
Video signal (HDMI)	Input terminals	HDMI
	Digital signal transmission system	TMDS (Single Link)
	Digital scanning frequency (H / V)	31 kHz to 68 kHz / 49 Hz to 61 Hz (VGA TEXT : 69 Hz to 71 Hz)
	Applicable video signal formats	480 p / 720 p / 1080 p : 60 Hz 576 p / 720 p / 1080 p : 50 Hz
USB	Port	Downstream port × 2
	Standard	USB Specification Revision 2.0
	Communication speed	480 Mbps (high), 12 Mbps (full), 1.5 Mbps (low)
	Supply current	Max. 500mA / 1 port
Power supply	Input	100-120 VAC ± 10%, 50 / 60 Hz 0.65 A 200-240 VAC ± 10%, 50 / 60 Hz 0.4 A
	Maximum power consumption	61 W or less
	Standby mode	33 W or less (with "Quick Start" set to "On") 3.0 W or less (with "Quick Start" set to "Off")
Physical specifications	Dimensions	563.5 mm × 411.5 mm × 157 mm (W × H × D) (tilt : 0°) 563.5 mm × 425 mm × 200 mm (W × H × D) (tilt : 30°)
	Dimensions (without stand)	563.5 mm × 325 mm × 63 mm (W × H × D)
	Net weight	Approx. 7.9 kg
	Net weight (without stand)	Approx. 5.5 kg
	Tilt	Up 30°, down 0°
Operating environmental specifications	Temperature	0 °C to 35 °C (32 °F to 95 °F)
	Humidity	20 % to 80 % R.H. (no condensation)
	Air pressure	540 hPa to 1060 hPa
Transportation/ Storage environmental specifications	Temperature	-20 °C to 60 °C (-4 °F to 140 °F)
	Humidity	10 % to 90 % R.H. (no condensation)
	Air pressure	200 hPa to 1060 hPa

*1 Images are not displayed when the maximum resolution is exceeded. Reduce the resolution and / or the bit rate set for the network camera.

● Display capability

The table below shows the display capability of this product

H.264 (when the “Bit rate” is set at “4096kbps”)

At 1-screen display	1920 × 1080 / 30 fps
At 3-screen display	640 × 1024 / 30 fps
At 4-screen display	1920 × 1080 / 20 fps
At 8-screen display	1280 × 720 / 20 fps
At 9-screen display	1280 × 720 / 20 fps
At 16-screen display	640 × 480 / 30 fps

MJPEG

640 x 480 / 30 fps

Attention

- The above values are provided for reference purposes. Images are not displayed properly when display capability is exceeded because of network camera settings, network installation environment or other reasons. When images are not displayed properly, reduce the network camera resolution and bit rate. Set network camera settings in accordance with the camera's manual.

● Outline Dimensions

Unit: mm

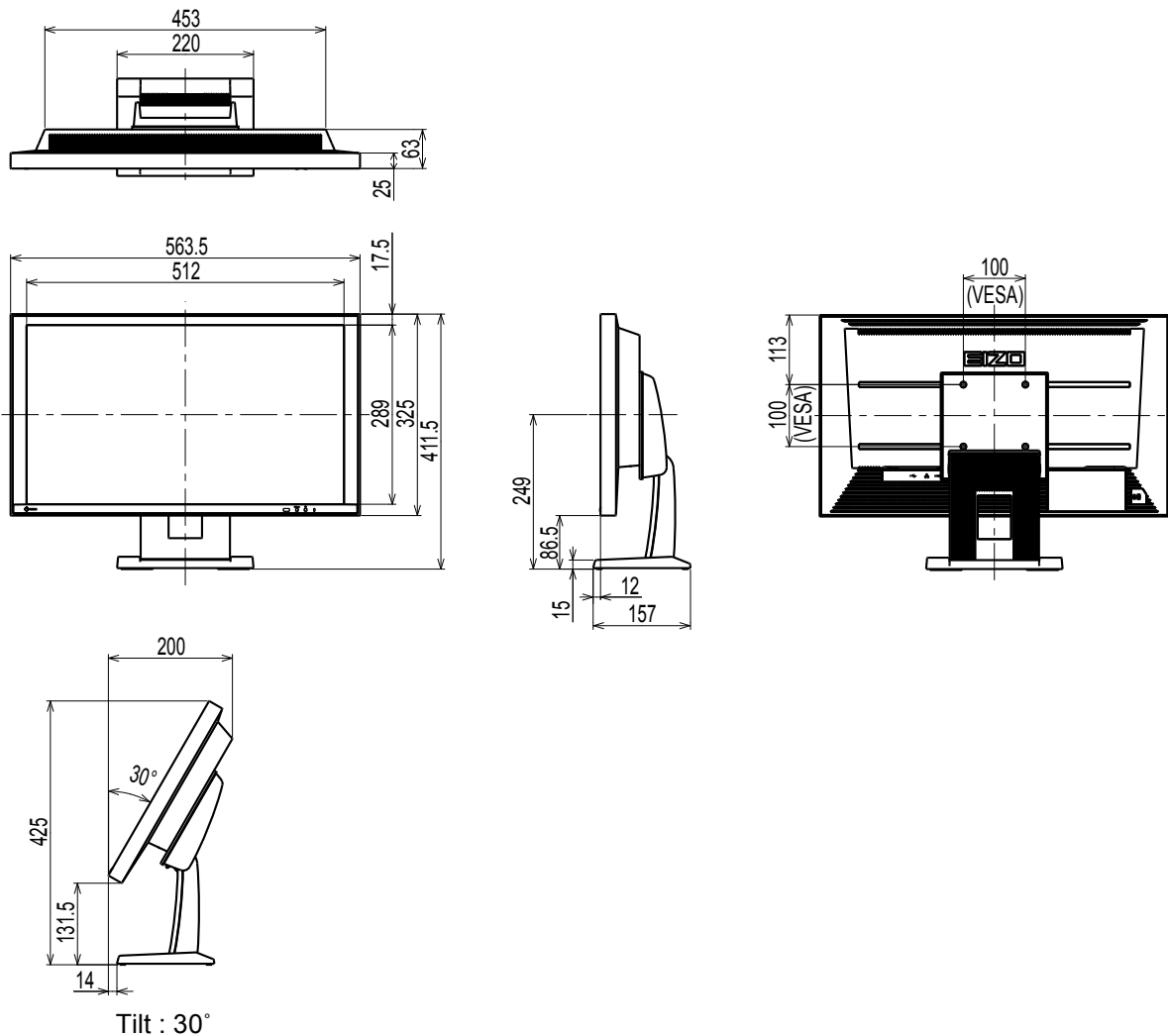

Appendix

FCC Declaration of Conformity

For U.S.A. , Canada, etc. (rated 100-120 Vac) Only

FCC Declaration of Conformity

We, the Responsible Party

EIZO Inc.

5710 Warland Drive, Cypress, CA 90630

Phone: (562) 431-5011

declare that the product

Trade name: EIZO

Model: DuraVision FDF2304W-IP

is in conformity with Part 15 of the FCC Rules. Operation of this product is subject to the following two conditions: (1) this device may not cause harmful interference, and (2) this device must accept any interference received, including interference that may cause undesired operation.

This equipment has been tested and found to comply with the limits for a Class B digital device, pursuant to Part 15 of the FCC Rules. These limits are designed to provide reasonable protection against harmful interference in a residential installation. This equipment generates, uses, and can radiate radio frequency energy and, if not installed and used in accordance with the instructions, may cause harmful interference to radio communications. However, there is no guarantee that interference will not occur in a particular installation. If this equipment does cause harmful interference to radio or television reception, which can be determined by turning the equipment off and on, the user is encouraged to try to correct the interference by one or more of the following measures.

- * Reorient or relocate the receiving antenna.
- * Increase the separation between the equipment and receiver.
- * Connect the equipment into an outlet on a circuit different from that to which the receiver is connected.
- * Consult the dealer or an experienced radio/TV technician for help.

Changes or modifications not expressly approved by the party responsible for compliance could void the user's authority to operate the equipment.

Note

Use the attached specified cable below or EIZO signal cable with this monitor so as to keep interference within the limits of a Class B digital device.

- AC Cord
- Shielded Signal Cable (enclosed)

Canadian Notice

This Class B digital apparatus complies with Canadian ICES-003.

Cet appareil numérique de la classe B est conforme à la norme NMB-003 du Canada.



EIZO Corporation

153 Shimokashiwano, Hakusan, Ishikawa 924-8566 Japan
Phone: +81 76 277 6792 Fax: +81 76 277 6793

EIZO Europe GmbH

Helmut-Grashoff-Strasse 18, 41179 Mönchengladbach, Germany
Phone: +49 2161 8210210 Fax: +49 2161 8210150

艺卓显像技术(苏州)有限公司

中国苏州市苏州工业园区展业路 8 号中新科技工业坊 5B
Phone: +86 512 6252 0100 Fax: +86 512 6252 1508

<http://www.eizoglobal.com>

Copyright © 2014-2016 EIZO Corporation. All rights reserved.

6th Edition-August, 2016 Printed in Japan.

00NOL856F1
(SUM-FDF2304WIP-4)