



# White Paper

## Seven Ergonomic Features of the FlexScan EV Series

### CONTENTS

<b>1. Introduction .....</b>	<b>2</b>
<b>2. Automatic brightness adjustment function (Auto EcoView) .....</b>	<b>3</b>
<b>3. Flicker-free function (EyeCare Dimming) .....</b>	<b>7</b>
<b>4. Paper-like display function (Paper Mode) .....</b>	<b>9</b>
<b>5. Function to reduce impact of blue light on sleep (Circadian Dimming Function) .....</b>	<b>13</b>
<b>6. Change in brightness during monitor use .....</b>	<b>14</b>
<b>7. Anti-reflective treatment .....</b>	<b>15</b>
<b>8. Fully adjustable monitor stand .....</b>	<b>15</b>
<b>9. Conclusion .....</b>	<b>16</b>
<b>10. Comment by Lecturer Takushi Kawamorita, Department of Orthoptics and Visual Science, School of Allied Health Sciences, Kitasato University .....</b>	<b>17</b>

No.14-003 Revision B

December 2015

Product & Business Development Dept.

Product Technology Section

# 1. Introduction

Over the past several years, the progress and development of computers and information technology have naturally caused a large part of the jobs and tasks conventionally done on paper to be replaced with those on the screens of computers, tablets, smartphones, and other such devices.

From the standpoint of convenience and efficiency, it is quite natural to work with those devices for collecting information or doing other tasks. However, very few people seem to care about the fatigue on the eyes or other parts of the body as a result of continuous viewing of displays.

EIZO, as a monitor manufacturer, has incorporated various ergonomic ideas into our monitor products from the user's perspective. Our FlexScan EV series, which was developed on the assumption that the monitors are used for many hours in offices or similar settings, is equipped with the highest level of ergonomic features among EIZO products.

The EV series was developed with the concept of Eco plus View (easy on the eyes). This White Paper provides outlines on the functions of the latest products in our FlexScan EV series.



**FlexScan  
EV2455**



**FlexScan  
EV2450**



**FlexScan  
EV3237**

## 2. Automatic brightness adjustment function (Auto EcoView)

The automatic brightness adjustment (Auto EcoView) function was first introduced in the FlexScan L550, which was brought to the market in 2003. At that time, this function was called BrightRegulator, and it enabled the adjustment of monitor brightness under a certain environment to avoid excessive glare.

The name of this function was changed to Auto EcoView for the second generation and later, and improvements were made. The second generation of this function enabled adjustments for two types of ambient environments (light and dark), which therefore was called 2-Point Adjustment. The present version, or the 4th generation, of Auto EcoView combines the advantages of 2-Point Adjustment, which allows detailed setting, and 1-Point Adjustment, which allows simple setting (three points in total), enabling automatic brightness adjustment for various environments.

### 2-1. New Auto EcoView (4th generation) with practical support for wide range of ambient illuminance

The 4th generation Auto EcoView uses three points for brightness adjustment: Point P1 in a light environment, Point P2 in a dark environment, and Point A in a normal environment. However, in most cases, there is no need for the user to do anything to adjust the monitor to optimum brightness because the optimum values derived from experiments at EIZO have been set as the factory default.

The 4th generation Auto EcoView automatically follows the changes in the brightness of the room caused by changes in sunlight or illumination. The user can also fine-adjust the brightness by moving Point A up or down.

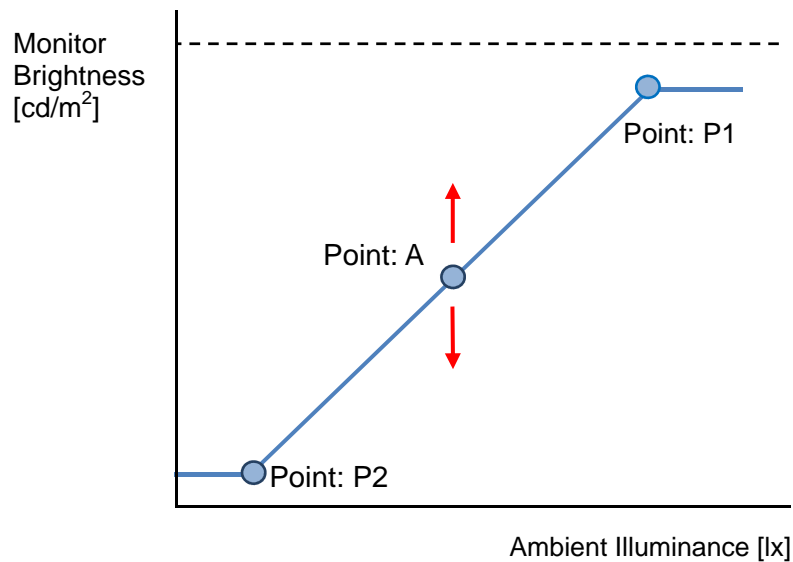

Figure 1: New Auto EcoView

## 2-2. Separate brightness adjustment for bright and dark environments

With the 4th generation Auto EcoView, the user can fine-adjust the brightness in extremely bright or dark environments by setting Point P1 or P2 in the Advanced Settings window as shown below.

Advanced Settings (Auto EcoView)		
Maximum		
Brightness	[	80 ]
Ambient Light	[	Bright ]
Minimum		
Brightness	[	20 ]
Ambient Light	[	Dark ]
Reset		

Figure 2: Separate brightness adjustment

## 2-3. Evaluation of Auto EcoView

Auto EcoView was evaluated by the Department of Orthoptics and Visual Science, School of Allied Health Sciences, Kitasato University.

The evaluation was performed under ambient illuminance of 250 [lx], for two different brightness values: 70 [cd/m<sup>2</sup>] (equivalent to the value when Auto EcoView is activated) and 270 [cd/m<sup>2</sup>] (excessively bright).

### 1. Change of pupil diameter

When the subjects moved their eyes from paper to the screen, the pupils were more prone to constriction if the Auto EcoView function was set to OFF. (Evaluated using the Scheffé's test and ANOVA)

Change of pupil diameter  
Monitor-Paper [%]

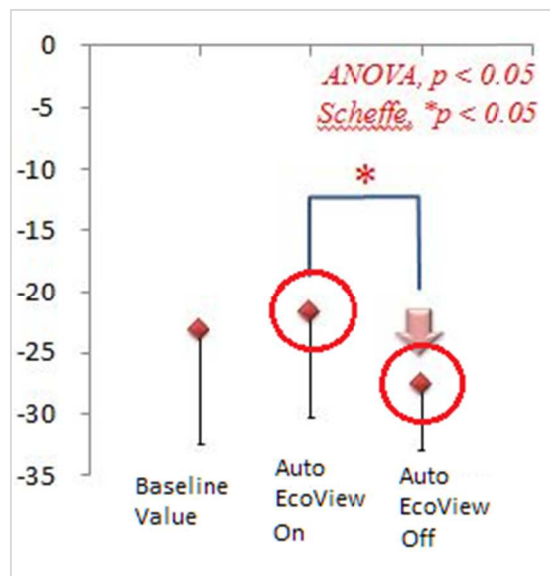

Figure 3: Change of pupil diameter

Evaluated by School of Allied Health Sciences, Kitasato University

## 2. Critical flicker frequency (CFF) test

CFF refers to the frequency limit at which the blinking of an image becomes unrecognizable. In this test, if the Auto EcoView function was set to off, the CFF value tended to be smaller (indicating fatigue).

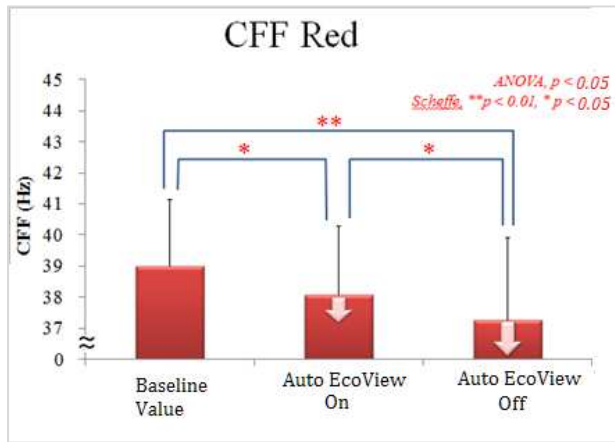

Figure 4: CFF (Red)

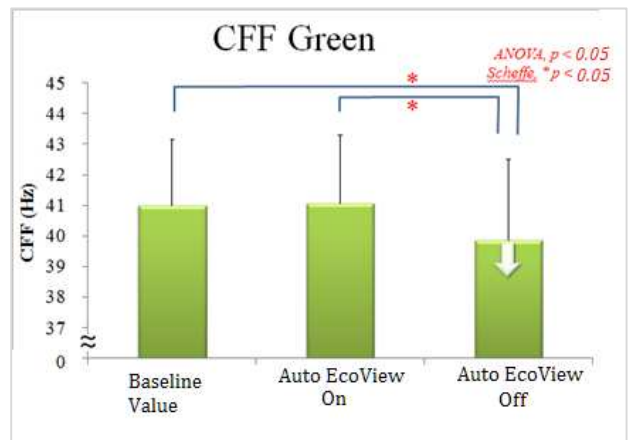

Figure 5: CFF (Green)

Evaluated by School of Allied Health Sciences, Kitasato University

## 3. Subjective evaluation (questionnaire)

The results revealed that subjects felt less fatigue and that it was easier to view the screen with the Auto EcoView function activated.

Question: Do you feel eye fatigue before or after using a PC with Auto EcoView on or off?

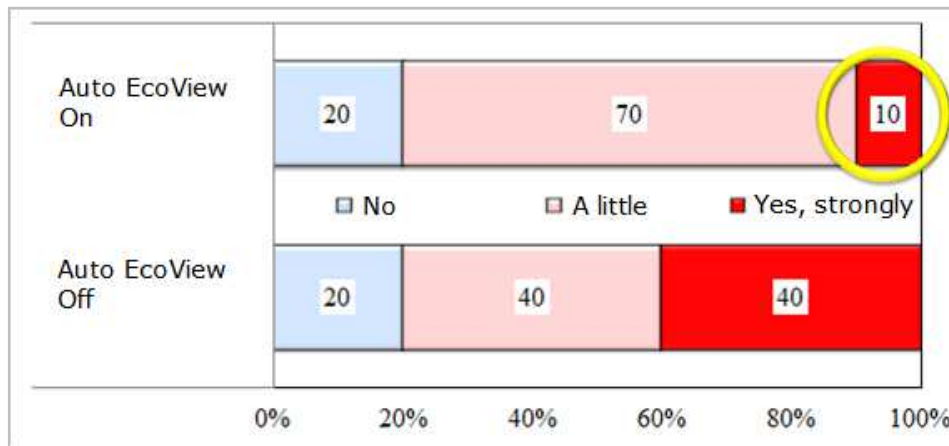

Figure 6: Subjective evaluation (questionnaire)

Evaluated by School of Allied Health Sciences, Kitasato University

Question: Do you feel stiff or have pain in the neck, shoulders and back before or after using a PC with EcoView on or off?

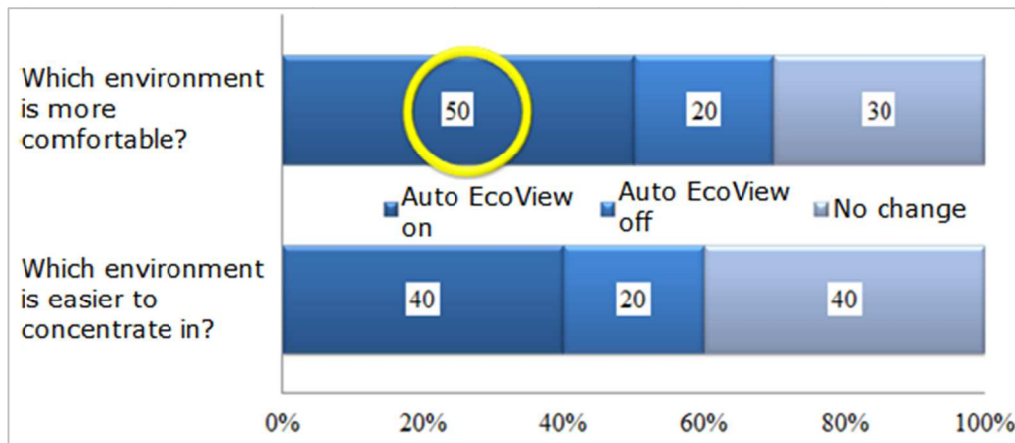

Figure 7: Subjective evaluation (questionnaire)

Evaluated by School of Allied Health Sciences, Kitasato University

On the whole, both the objective and subjective evaluation results indicated the effectiveness of the Auto EcoView function. When the Auto EcoView function is set to OFF, the larger difference in brightness when moving the eyes from paper to the screen forces the pupils to adjust more drastically, which can lead to fatigue.

### 3. Flicker-free function (EyeCare Dimming)

#### 3-1. Dimming methods

EyeCare Dimming is a function to minimize the flicker of LED backlit monitors, which is caused in relation to brightness control.

Conventionally, for controlling LED backlit monitor brightness, the pulse width modulation (PWM) method has commonly been used to change the perceived luminance.

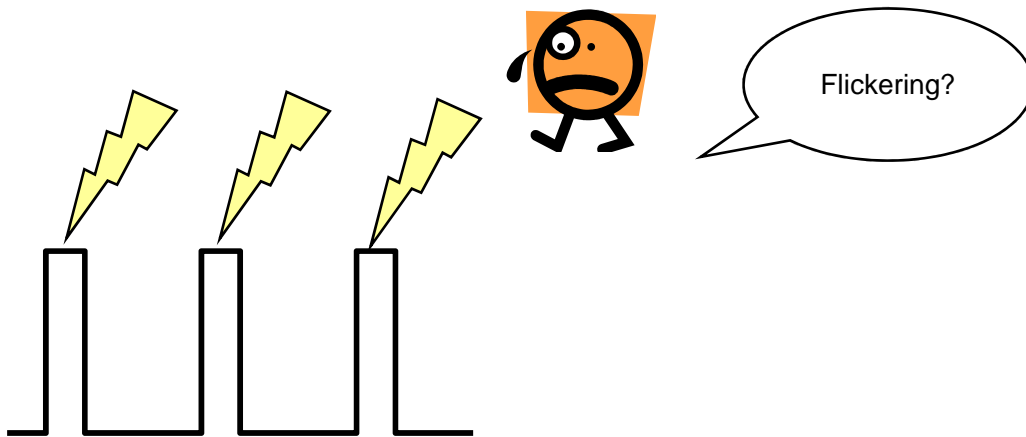

Figure 8: Brightness control by PWM method

At EIZO, we decided to use the direct current (DC) method, instead of the PWM method, in order to avoid flickering in principle. However, since it is difficult to achieve low brightness with the DC method, we also employed the PWM method for the low brightness range. The EyeCare dimming function is a hybrid of the DC and PWM methods, which allows comfortable operations even in an environment like a darkroom.

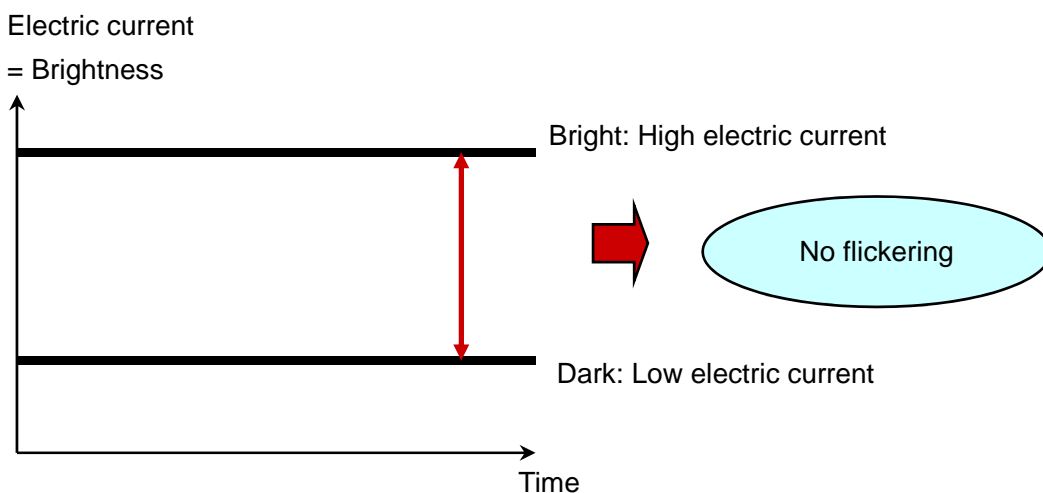

Figure 9: Brightness control by DC method

### 3-2. Evaluation of DC dimming

We asked the Department of Orthoptics and Visual Science, School of Allied Health Sciences, Kitasato University to evaluate the DC dimming method in terms of subjective fatigue and viewability using a questionnaire. The summarized results are as follows:

#### Questionnaire on Subjective Fatigue and Viewability

The results show a tendency among the subjects to feel less fatigue with the DC method than with the PWM method. Displays with the DC method also had a tendency to be easier to view and concentrate with.

#### Do you perceive flicker?

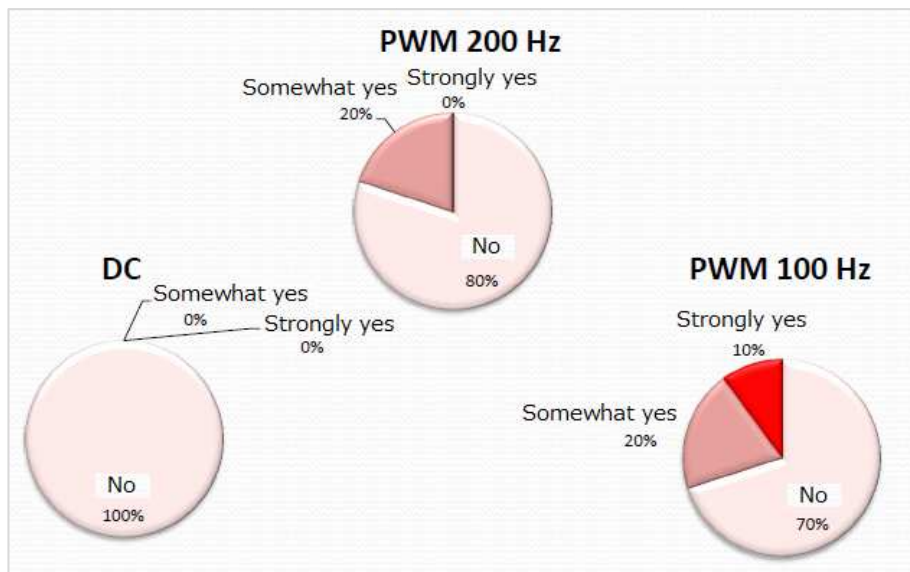

Figure 10: Do you perceive flicker? (questionnaire)

Evaluated by School of Allied Health Sciences, Kitasato University

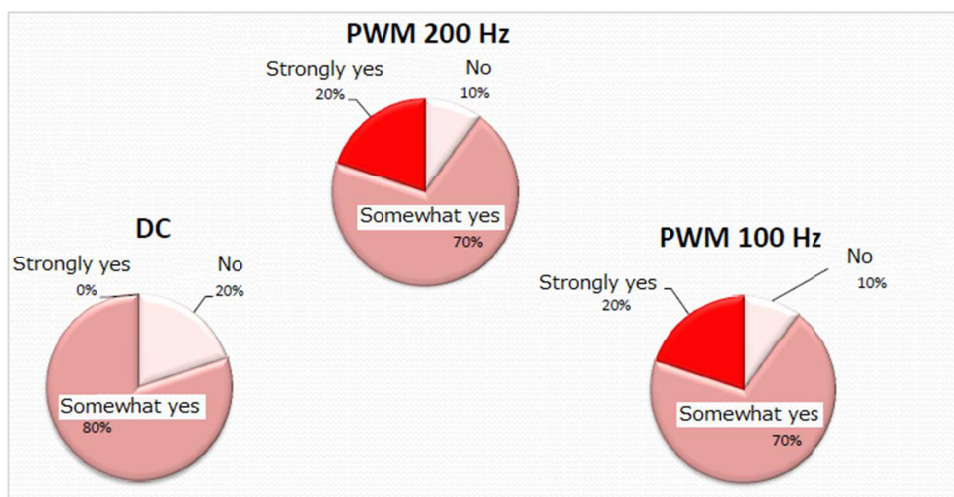

Figure 11: Do you feel fatigue? (questionnaire)

Evaluated by School of Allied Health Sciences, Kitasato University



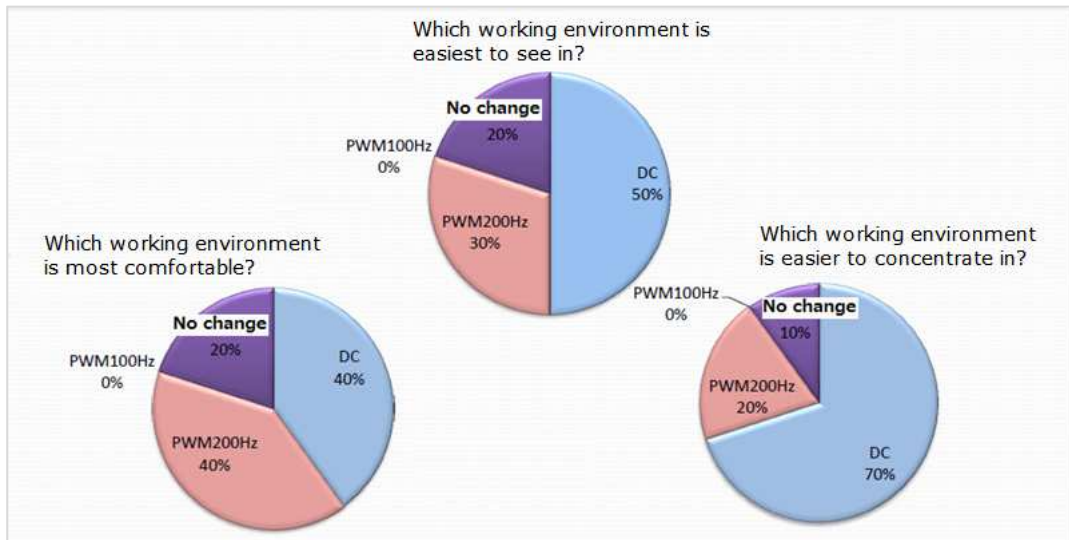

Figure 12: Which environment is easiest to see in? (questionnaire)

Evaluated by School of Allied Health Sciences, Kitasato University

## 4. Paper-like display function (Paper Mode)

Since ancient times, people have been using paper to write letters or draw pictures. Things written or drawn on paper look somewhat different from those on monitor screens. There are also many people who say that the text on paper is somehow easier to read than that on screen.

EV series displays come with a Paper Mode, in which the images shown on screen are made as close as possible to those on paper. This was achieved by analyzing the difference between paper and screen.

### 4-1. Difference in resolution

First of all, the resolution is different between the paper (printed matters) and the screen. In general, the resolution of printed matters is determined by the screen ruling measured in lines per inch (lpi).

Table 1 lists the screen ruling of typical media such as newspapers, along with the corresponding required screen resolution in pixels per inch (ppi). These values indicate the necessary resolution to display images close to those on paper. Actual monitor resolution at present is low at 93–96 ppi or so (FlexScan EV2450, EV2455); however, the resolution of recent 4K monitors (FlexScan EV3237) reaches about 140 ppi, gradually getting closer to printed material.

Media	Screen ruling (lpi)	Required screen resolution (ppi)
Newspaper	60 - 80	120 - 160
Book, Magazine	100 - 150	200 - 300
Brochure, Calendar	150 - 200	300 - 400

Table 1: Screen ruling and required screen resolution

## 4-2. Difference in brightness

Monitors, which emit light by themselves, are hardly affected by ambient light and color. On the other hand, printed material (documents, photos, etc.) is directly affected by ambient light and color. In addition, perceived paper brightness differs depending on type. Newspaper looks somewhat grayish, while copy paper looks more whitish. This is caused by the difference in reflectivity between paper types.

Table 2 shows the actual reflectivity of different types of paper. The rightmost column shows the theoretical values calculated to represent the perceived brightness of the paper at 500 [lx] (ambient illuminance of common offices). Consequently, the luminance is about 90 [cd/m<sup>2</sup>] on newspaper and about 110–130 [cd/m<sup>2</sup>] on copy paper. This means that monitors are too bright if they are used with their maximum brightness.

Media	Reflectivity	Brightness at 500[lx]
Newspaper	55 [%]	88 [cd/m <sup>2</sup> ]
Copy paper (recycled paper)	About 70 [%]	About 112 [cd/m <sup>2</sup> ]
PPC paper	About 80 [%]	About 130 [cd/m <sup>2</sup> ]

Table 2: General paper's reflectivity and equivalent brightness

## 4-3. Difference in contrast ratio

The contrast ratio refers to the ratio of the luminance of white parts and black parts (ordinarily the text).

Table 3 shows the results of measuring the contrast ratio of different media. The table indicates that the contrast ratio of newspaper is considerably low. This value is much lower than the contrast ratio of common monitors (approx. 1000:1). In other words, the contrast of monitors is too high compared to paper.

Media	Contrast ratio
Newspaper	6.2:1
Copy paper (Recycled paper)	10.7:1
Copy paper (a)	31:1
Copy paper (b)	37:1
Photo paper	49:1

Table 3: Contrast ratio of some media

#### 4-4. Difference in white color (color temperature)

The white color on the monitor screen can be represented by color temperature. As the white on the monitor is achieved by combining red, green, and blue pixels, it is possible to change the color temperature in any way by changing the ratio of the three colors.

As mentioned above, color on paper is affected by the ambient light. Under ordinary fluorescent light, the color temperature of white is mostly about 4,000 to 5,000 [K], creating a somewhat yellowish color. On the other hand, the color temperature of white on typical monitor screens is near 6,500 [K], creating a somewhat bluish color. These facts indicate that the color on the monitor is too bluish compared to paper.

Figure 13 is a CIE 1931 Color space diagram, showing the range of color visible by humans.

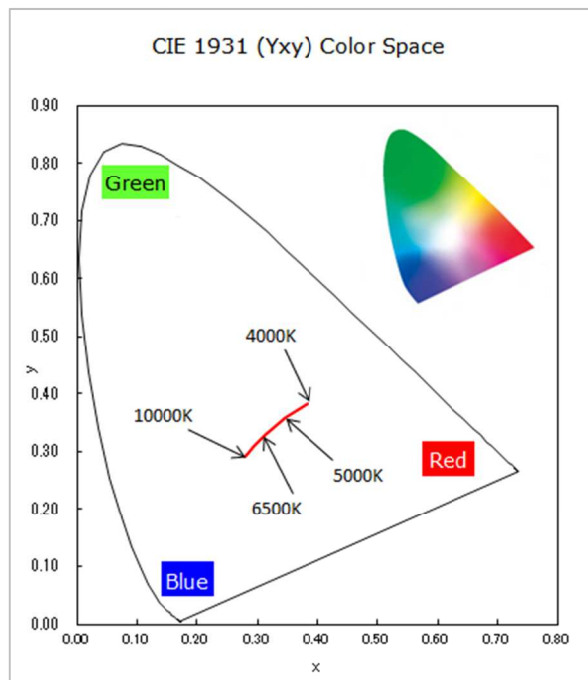

Figure 13: CIE1931 color space and color temperature

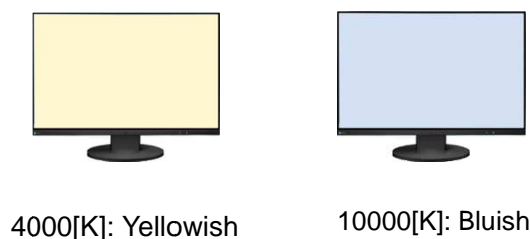

Figure 14: Yellowish and bluish color on the monitor

#### 4-5. Paper Mode setting

Taking into consideration the abovementioned differences between paper and the screen, Paper Mode was developed to make the brightness, color temperature, and contrast ratio of the monitor close to those of paper, in order to give the monitor a paper-like appearance.

When the monitor is set to Paper Mode, the user may feel that the screen is somewhat dark and yellowish at first but will notice, after using it for a while, that it is easier to see as it is similar to actual paper.

#### 4-6. Blue light cutting function of Paper Mode

In recent years, many people may have heard of the word “blue light.”

- Visible light    400 – 800 [nm]    Color can be recognized by the eyes
- Blue light      400 – 500 [nm]    Falls under visible light
- UVA            400 – 315 [nm]    99% of ultraviolet light reached to earth’s surface is UVA
- UVB            315 – 280 [nm]
- UVC            280 [nm] or lower    Mostly absorbed by ozone layer
- Ultraviolet light 10 – 400 [nm]

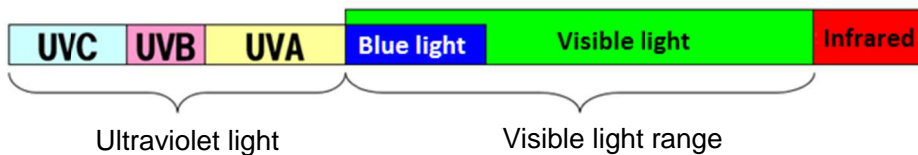

Figure 15: Visible light and Ultraviolet light

Blue light refers to light with a wavelength of 400–500 [nm], and falls under the category of visible light. Its adverse effects on the eyes and sleep have become a concern of late.

In Paper Mode, the color temperature is set to about 4,500 [K], at which blue light is considerably low. In other words, you could call Paper Mode Blue Light Cutting Mode. (Blue light is reduced by approx. 73 percent according to research by EIZO.)

## 5. Function to reduce impact of blue light on sleep (Circadian Dimming Function)

In relation to blue light mentioned above, it has recently been suggested that the use of a computer or smartphone should be avoided before bedtime. This is because blue light may have an adverse effect on the quality of sleep.

Generally speaking, people get up in the morning, are active in the daytime, and sleep at night based on a certain rhythm. This is called the circadian rhythm.

It is generally thought that sleep and wakefulness are physiological phenomena induced by the secretion of the sleep hormone (melatonin) and the wake hormone (serotonin, etc.) respectively, and blue light, which is found in both natural and artificial lights including LED light, is said to inhibit the secretion of melatonin, the sleep hormone.

### 5-1. Circadian Dimming software

Any monitor emits blue light to some extent if its colors are displayed with the three primary colors of red (R), green (G), and blue (B).

EIZO's ScreenManager Pro software includes a circadian dimming function that controls the change in color temperature of the monitor throughout the day. During the daytime, it causes the monitor to display bluish lights at 5,000–6,500 [K] (ordinary color) close to the natural outdoor light. As the evening approaches, the outdoor light (the sunlight) becomes yellowish with color temperatures at 4,000 [K] or lower, and the software accordingly changes the monitor color temperature so the screen becomes yellowish.

If the screen becomes yellowish with color temperature at 4,000 [K] or so, the blue light emission from the monitor will also decrease in principle. In addition, as the ambient light becomes dark from the evening to late night, the abovementioned Auto EcoView function is activated, which also contributes to the reduction of blue light. It is thought that reduced blue light is less likely to inhibit the secretion of melatonin, leading to reduced impact on sleep.

You may sometimes have no choice but to work with the monitor late at night. Even in such a case, this software will automatically decrease the emission of blue light from the monitor to minimize its impact on sleep.

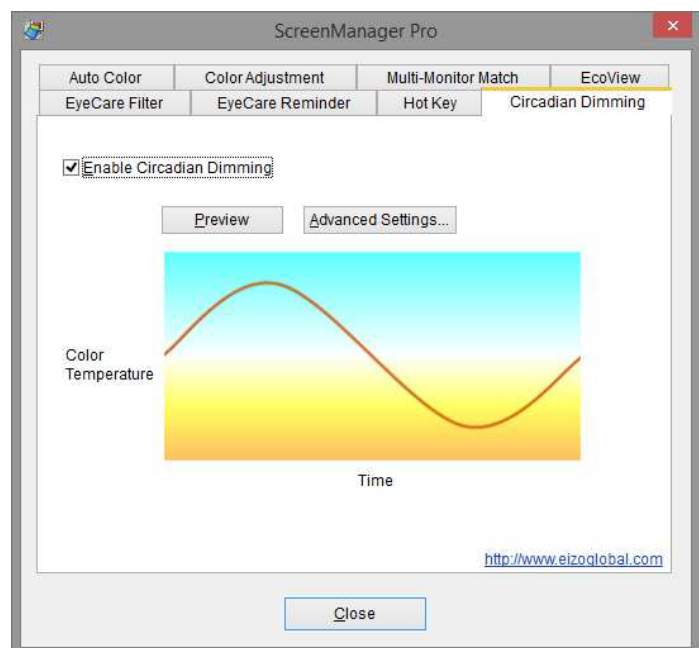

Figure 16: Circadian Dimming software

## 5-2. Relationship between blue light from a monitor and the ease of falling asleep

We performed a simple test to evaluate the relationship between blue light and the ease of falling asleep. We had one person work with a computer for 1–2 hours until immediately before going to bed using the following two conditions: 1) bright and bluish monitor state with a monitor luminance of 177 [cd/m<sup>2</sup>] and blue light luminance of 12.6 [cd/m<sup>2</sup>]; and 2) dark and yellowish monitor state with a monitor luminance of 30 [cd/m<sup>2</sup>] and blue light luminance of 0.9 [cd/m<sup>2</sup>]. The sleep state was measured using a sleep sensor for several days for each condition.

The results show a tendency for it to take the subject longer to fall asleep under the former condition with a higher blue component. This suggests that the monitor display before going to bed is less likely to affect the ease of falling asleep if it has a lower blue component.

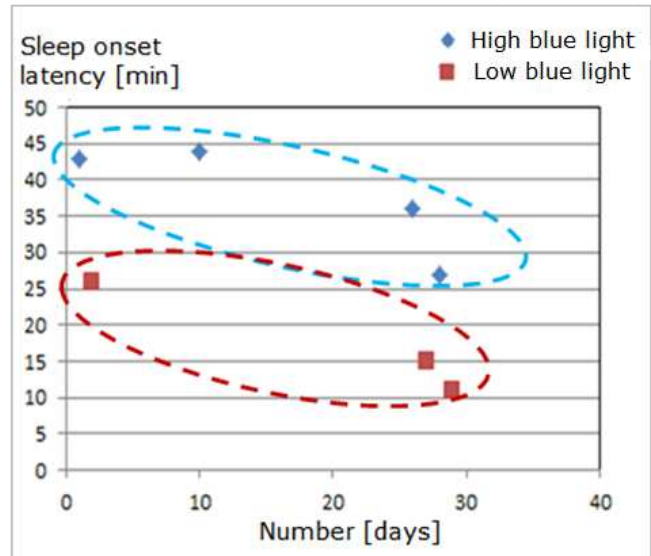

Figure 17: Blue light and sleep onset latency

Researched by EIZO

## 6. Change in brightness during monitor use

Consistent screen brightness during use is another feature of the new products in the EV series. In the case of conventional monitors, the screen brightness temporarily goes to the maximum value before it gets to a normal state after turning the power on, after switching signals, after restoration from the power-saving state, or in other similar conditions. On the other hand, the new EV series monitors retain the brightness conditions that are applied during use, thus minimizing the changes in brightness. This feature, designed from the perspective of those who use monitors for many hours, also contributes to the prevention of eye fatigue.

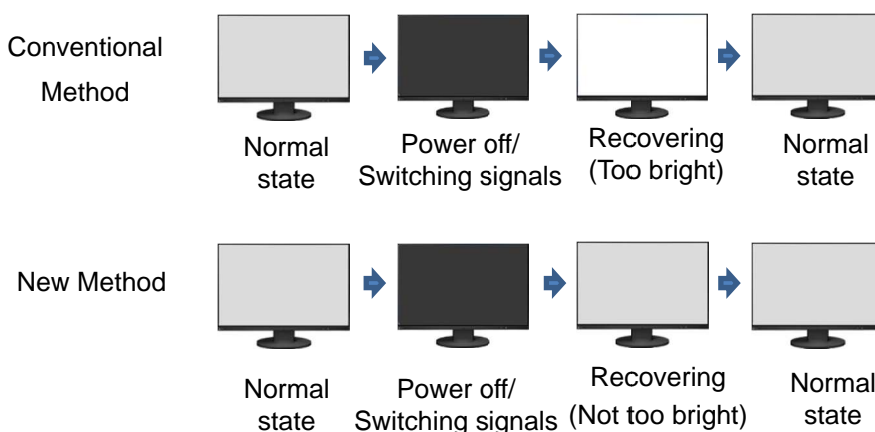

Fig. 18: Change in brightness during monitor use

## 7. Anti-reflective treatment

Since monitors are used mostly in relatively bright environments, or under lighting, monitor surface treatment is extremely important to make the screen easy to see. All EIZO monitors, including those of the EV series, come with a non-glare treated LCD panel to prevent the reflection of the lighting or other bright objects. In addition, anti-reflective treatment has been consistently applied to the frames (bezels) and the stands, which are in the line of sight, in order to maintain user comfort and prevent fatigue due to reflection.



Fig. 19: Reflection of monitor surface

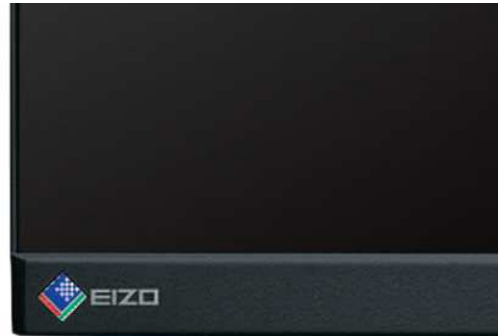

Fig. 20: Anti-reflective treatment of bezel

## 8. Fully adjustable monitor stand

How the monitor is placed is also important for user comfort. EIZO monitor stands have been designed to combine stability and flexibility, allowing the monitor to be placed in a comfortable position, while avoiding reflection of outside light. The new EV series monitors are equipped with the third-generation FlexStand, which features an enlarged screen position adjustment range, covering tilt, swivel, rotation, and up-down adjustments.

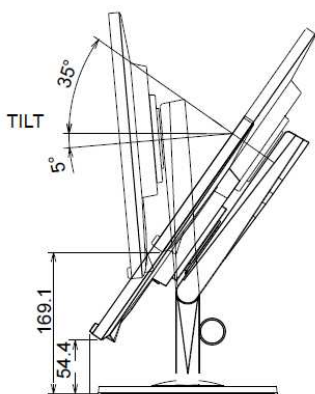

Figure 21: Tilt

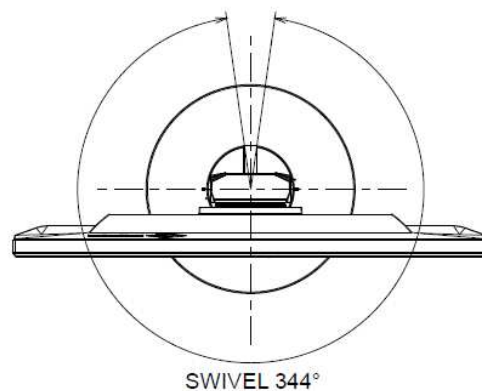

Figure 22: Swivel

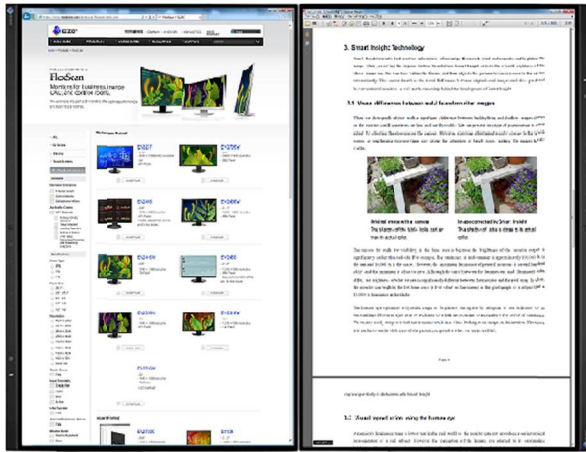

Figure 23: Two monitors in portrait mode aligned side-by-side



Figure 24: Monitor can be placed in a comfortable position

## 9. Conclusion

The new EV series monitors, which were developed using EIZO's ergonomics technology, are equipped with the following features to minimize physical fatigue, including eye fatigue:

1. Automatic brightness adjustment (Auto EcoView)
2. Flicker-free (EyeCare Dimming)
3. Paper-like display (Paper Mode)
4. Reduction of impact on sleep (Circadian Dimming)
5. Consistent screen brightness during use
6. Anti-reflective surface treatment
7. Highly-flexible stand structure

Although the features do not stand out on their own, we believe that the user will realize their value through long-term use of the product. We will continue to design and produce ergonomic monitors.



## 10. Comment by Lecturer Takushi Kawamorita, Department of Orthoptics and Visual Science, School of Allied Health Sciences, Kitasato University

“We are currently conducting research on vision-oriented design and evaluation. On this occasion, we conducted two evaluation experiments on EIZO’s Auto EcoView and Flicker-free (EyeCare Dimming) functions.” (Takushi Kawamorita, Lecturer, and Hiroshi Uozato, Professor, at Department of Orthoptics and Visual Science, School of Allied Health Sciences, Kitasato University)

### 10-1. Evaluation of Auto EcoView function

“To put it concisely, the evaluation experiment on the Auto EcoView function aimed to see whether the monitor screen brightness should be lowered or not when the ambient brightness becomes dark. I think many people, when they work with a computer, probably move their eyes between the monitor and the material at hand. At that time, if the difference in the intensity of incident light in the eyes is significant, between when viewing the monitor and when viewing the paper, the pupil diameter will change more remarkably when the eyes are moved between them (Figure 25). This makes it more probable that the difference will frequently stimulate the autonomic nervous system and affect the focusing function of the eyes and the quality of visual perception. This experiment allowed us to confirm the changes in pupil diameter, and the flicker test results and a questionnaire indicated the possibility that the Auto EcoView function may reduce fatigue. (Flicker tests are generally used as an index of mental fatigue and cerebral activity in the field of industrial psychiatry.) Recently, monitor performance has improved, and they have become brighter. However, the results suggest that it is also important to consider the strain on the eyes.”



Fig. 25: Comparison of pupil diameter when gazing characters on the paper and screen, in dark environmental illuminances (250 [lx]) and bright screen (270 [cd/m<sup>2</sup>]).

### 10-2. Evaluation of flicker-free function

“Through the evaluation examination on the flicker-free function, we evaluated the difference in flickering between two monitor brightness control methods: direct current (DC) dimming and pulse width modulation (PWM) dimming. Fatigue was also evaluated for each method. DC dimming does not generate flicker in principle, although it is difficult to achieve low brightness. PWM dimming controls the intervals of blinking, and in the case of monitors, its frequency is set to a higher value than the limit at which people can barely recognize flicker. Therefore, before the experiment, I expected that there would be no difference between the two methods, and I was not able to recognize any difference when I actually tried it myself. Contrary to my expectation, the experimental results revealed that there were some subjects who felt a flicker even at a high frequency, and that higher frequencies caused the

subjects to feel less fatigue. Another interesting fact was that the subjects who were sensitive to flickering screens were able to distinguish the difference between monitors without hesitation from their appearance alone. There is no clear answer to why some people are sensitive to flickering while some are not, and why such a phenomenon occurs at flickering frequencies exceeding the limit at which blinks are said to become unrecognizable by human eyes. However, the closer to this limit the frequency was, the more the subjects perceived flickering of the screen. Moreover, when the frequency was gradually changed, flickering cyclically appeared and disappeared. This may have something to do with some kind of visual phenomena, such as synchronization or interference. In any case, using DC dimming, which generates no flickering in principle, should reduce the occurrence of fatigue and discomfort caused by flickering.”

### **10-3. Other ergonomic features**

“In addition to the two functions on which we conducted evaluation experiments this time, EIZO has developed various ergonomic features. In particular, I am interested in Paper Mode, which makes the viewability of the monitor close to that of paper, and the Circadian Dimming Function, which adapts the display to human circadian rhythm. Paper Mode was designed to give the monitor the ease of viewing and reading that we intuitively feel about paper. At present, this feature is applied to the adjustment of brightness, contrast, and color temperature. EIZO is also planning to study the effectiveness of higher definition, flexibility, and curved surface of monitors in the future. I expect that monitors, in synergy with people’s familiarization, will certainly surpass paper someday.

The Circadian Dimming Function makes the display emit a higher blue component during the daytime, and lowers it during the nighttime. Although it requires continued study from various angles, this seems to be an important approach that involves a time scale. Recently, there is a trend of decreasing the amount of blue light. Certainly, blue light is apt to scatter and look dazzling, and it has high energy, so it seems reasonable to cut down on blue light. However, some research reports have indicated that taking in sufficient blue light during the daytime is good for both physical and mental health; this means that blue light is also important. On the other hand, viewing blue light in the nighttime is said to impair sleep quality. Taking these theories into consideration, this Circadian Dimming Function, which was designed incorporating past research results, seems to be an appropriate feature for people who work with a computer for many hours or those who get tired easily.

“Recent monitor technologies and the speed of development are simply marvelous. In the future, it probably will be necessary to further consider the proper level of performance and the methods of dealing with individual differences of users such as age. I think it will be more and more important to design and evaluate products centering on the people or the sense of sight, as with the ergonomic features in this article.”

Takushi Kawamorita,  
Department of Orthoptics and Visual Science, School of Allied Health Sciences, Kitasato University

