

取扱説明書 User's Manual

RadiForce® GS521-ST

モノクロ液晶ステレオモニター
Monochrome Stereoscopic LCD Monitor

重要

ご使用前には必ず本取扱説明書をよくお読みになり、正しくお使いください。この取扱説明書は大切に保管してください。

Important

Please read this User's Manual carefully to familiarize yourself with safe and effective usage. Please retain this manual for future reference.



For U.S.A. , Canada, etc. (rated 100-120 Vac) Only

FCC Declaration of Conformity

We, the Responsible Party

EIZO Inc.

5710 Warland Drive, Cypress, CA 90630

Phone: (562) 431-5011

declare that the product

Trade name: EIZO

Model: RadiForce GS521-ST

is in conformity with Part 15 of the FCC Rules. Operation of this product is subject to the following two conditions: (1) this device may not cause harmful interference, and (2) this device must accept any interference received, including interference that may cause undesired operation.

This equipment has been tested and found to comply with the limits for a Class B digital device, pursuant to Part 15 of the FCC Rules. These limits are designed to provide reasonable protection against harmful interference in a residential installation. This equipment generates, uses, and can radiate radio frequency energy and, if not installed and used in accordance with the instructions, may cause harmful interference to radio communications. However, there is no guarantee that interference will not occur in a particular installation. If this equipment does cause harmful interference to radio or television reception, which can be determined by turning the equipment off and on, the user is encouraged to try to correct the interference by one or more of the following measures.

- * Reorient or relocate the receiving antenna.
- * Increase the separation between the equipment and receiver.
- * Connect the equipment into an outlet on a circuit different from that to which the receiver is connected.
- * Consult the dealer or an experienced radio/TV technician for help.

Changes or modifications not expressly approved by the party responsible for compliance could void the user's authority to operate the equipment.

Note

Use the attached specified cable below or EIZO signal cable with this monitor so as to keep interference within the limits of a Class B digital device.

- AC Cord
- Shielded Signal Cable (Enclosed)

Canadian Notice

This Class B digital apparatus complies with Canadian ICES-003.

Cet appareil numérique de la classe B est conforme à la norme NMB-003 du Canada.





User's Manual

RadiForce® GS521-ST

Monochrome Stereoscopic LCD Monitor

SAFETY SYMBOLS

This manual uses the safety symbols below. They denote critical information. Please read them carefully.

 WARNING	
Failure to abide by the information in a WARNING may result in serious injury and can be life threatening.	
 CAUTION	
Failure to abide by the information in a CAUTION may result in moderate injury and/or property or product damage.	
	Indicates a prohibited action.
	Indicates to ground for safety.

The approved standards in this manual are those that the RadiForce GS521 has met and acquired.

This product has been adjusted specifically for use in the region to which it was originally shipped. If operated outside this region, the product may not perform as stated in the specifications.

- It shall be assured that the final system is in compliance to IEC60601-1-1 requirement.
- Power supplied equipment can emit electromagnetic waves, that could influence, limit or result in malfunction of the monitor.
Install the equipment in a controlled environment, where such effects are avoided.
- This is a monitor intended for use in a medical image system.

No part of this manual may be reproduced, stored in a retrieval system, or transmitted, in any form or by any means, electronic, mechanical, or otherwise, without the prior written permission of EIZO Corporation. EIZO Corporation is under no obligation to hold any submitted material or information confidential unless prior arrangements are made pursuant to EIZO Corporation's receipt of said information. Although every effort has been made to ensure that this manual provides up-to-date information, please note that EIZO monitor specifications are subject to change without notice.

Windows, Windows Vista, Windows Media, SQL Server, and Xbox 360 are registered trademarks of Microsoft Corporation in the United States and other countries.

A round gothic bold bit map font designed by Ricoh is used for the characters displayed on this product.

VESA is a registered trademark or a trademark of the Video Electronics Standards Association in the United States and other countries.

EIZO, the EIZO Logo, RadiCS, RadiForce, RadiNET and ScreenManager are registered trademarks of EIZO Corporation in Japan and other countries.

All other company and product names are trademarks or registered trademarks of their respective owners.

PRECAUTIONS





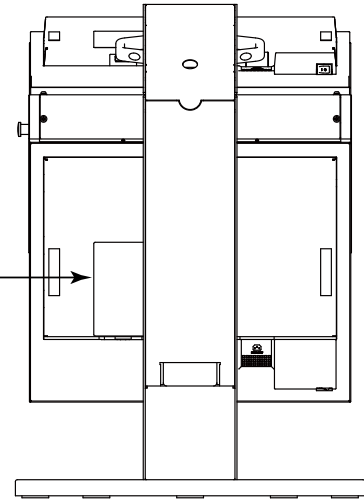
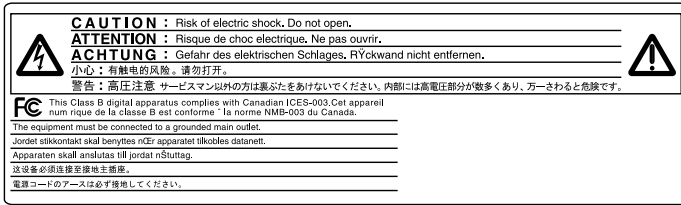

IMPORTANT!

- This product has been adjusted specifically for use in the region to which it was originally shipped. If operated outside the region to which it was originally shipped, the product may not perform as stated in the specifications.
- To ensure personal safety and proper maintenance, please read this section and the caution statements on the unit (refer to the figure below).

● Location of the Caution Statements



● Symbols on the unit

Symbol	This symbol indicates
	Main Power Switch Press to turn the monitor's main power off
	Main Power Switch Press to turn the monitor's main power on.
	Power Switch Press to turn the monitor's power on or off.
	Alternating current
	Alerting electrical hazard
	Caution Refer to SAFETY SYMBOLS section in this manual.

WARNING

If the unit begins to emit smoke, smells like something is burning, or makes strange noises, disconnect all power connections immediately and contact your dealer for advice.

Attempting to use a malfunctioning unit may result in fire, electric shock, or equipment damage.

Do not open the cabinet or modify the unit.

Opening the cabinet or modifying the unit may result in fire, electric shock, or burn.



Refer all servicing to qualified service personnel.

Do not attempt to service this product yourself as opening or removing covers may result in fire, electric shock, or equipment damage.

Keep small objects or liquids away from the unit.

Small objects accidentally falling through the ventilation slots into the cabinet or spillage into the cabinet may result in fire, electric shock, or equipment damage. If an object or liquid falls/spills into the cabinet, unplug the unit immediately. Have the unit checked by a qualified service engineer before using it again.



Place the unit in a sturdy location that can support the product's weight (about 24.5 kg).

- A unit placed on an inadequate surface may fall and result in injury or equipment damage. If the unit falls, disconnect the power immediately and ask your dealer for advice. Do not continue using a damaged unit. Using a damaged unit may result in fire or electric shock.
- Firmly grasp the upper monitor and fix the main unit in position with the wire to prevent earthquake damage (sold separately).

Set the unit in an appropriate location.

Not doing so may result in fire, electric shock, or equipment damage.

- Do not place outdoors.
- Do not place in the transportation system (ship, aircraft, trains, automobiles, etc.)
- Do not place in a dusty or humid environment.
- Do not place in a location where water is splashed on the screen (bathroom, kitchen, etc.).
- Do not place in a location where the steam comes directly on the screen.
- Do not place near heat generating devices or a humidifier.
- Do not place in a location where the product is subject to direct sunlight.
- Do not place in an inflammable gas environment.



To avoid danger of suffocation, keep the plastic packing bags away from babies and children.

Use the enclosed power cord and connect to the standard power outlet of your country.

Be sure to remain within the rated voltage of the power cord. Not doing so may result in fire or electric shock. Power supply: 100-120/200-240 Vac, 50/60 Hz

To disconnect the power cord, grasp the plug firmly and pull.

Tugging on the cord may damage and result in fire or electric shock.



WARNING

The equipment must be connected to a grounded main outlet.

Not doing so may cause in fire or electric shock.



Use the correct voltage.

- The unit is designed for use with a specific voltage only. Connection to another voltage than specified in this User's Manual may cause fire, electric shock, or equipment damage.
Power supply: 100-120/200-240 Vac, 50/60 Hz
- Do not overload your power circuit, as this may result in fire or electric shock.

Handle the power cord with care.

- Do not place the cord underneath the unit or other heavy objects.
- Do not pull on or tie the cord. If the power cord becomes damaged, stop using it. Use of a damaged cord may result in fire or electric shock.



For the electrical safety, do not connect or disconnect the power cord in the presence of patients.

Never touch the plug and power cord if it begins to thunder.

Touching them may result in electric shock.



Do not touch a damaged LCD panel directly with bare hands.

The liquid crystal which leaks from the panel is poisonous if it enters the eyes or mouth. If any part of the skin or body comes in direct contact with the panel, please wash thoroughly. If some physical symptoms result, please consult your doctor.



Fluorescent backlight lamps contain mercury (the products that have LED backlight lamps contain no mercury), dispose according to local, state or federal laws.

Exposure to elemental mercury can result in effects on the nervous system, including tremor, memory loss, and headache.

CAUTION

Handle with care when carrying the unit.

Disconnect the power cord and cables when moving the unit. Moving the unit with the cord attached is dangerous. It may result in injury.

Carry or place the unit according to the correct specified methods.

- When carrying the unit, remove the half-silvered mirror and then grasp and hold firmly the bottom of the monitor as shown in the illustration on the right. Do not touch the panel surface.
- Do not unpack or carry the unit only by a single person, since the large size unit is so heavy. Dropping the unit may result in injury or equipment damage.

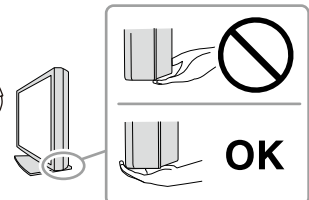
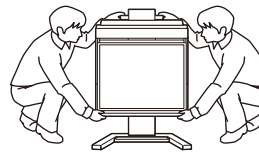

Avoid applying impactive force.

Do not apply impactive force to the unit. It may result in equipment damage.

CAUTION

Firmly fix the half-silvered mirror and attach the fall prevention cap.

If the half-silvered mirror falls, it may result in injury.

When raising the half-silvered mirror, make sure that it is locked. Never put your head under the upper monitor.

To view a two-dimensional image, raise the half-silvered mirror and firmly lock it. If the half-silvered mirror falls, it may result in injury.

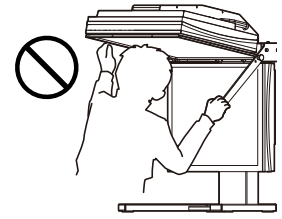

If you discover any damage such as cracks on the half-silvered mirror, stop the operation immediately and ask your dealer for advice.

It may result in injury.

Raise the half-silvered mirror or return it to its original position slowly with both hands.

- Make sure not to get your hand stuck in the left and right arms.
- It may result in injury.

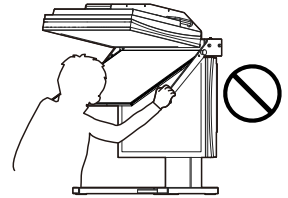

Do not block the ventilation slots on the cabinet.

- Do not place any objects on the ventilation slots.
- Do not install the unit in a closed space.
- Do not use the unit laid down or upside down.

Blocking the ventilation slots prevents proper airflow and may result in fire, electric shock, or equipment damage.



Do not touch the plug with wet hands.

Doing so may result in electrical shock.



Use an easily accessible power outlet.

This will ensure that you can disconnect the power quickly in case of a problem.

Periodically clean the area around the plug.

Dust, water, or oil on the plug may result in fire.

Unplug the unit before cleaning it.

Cleaning the unit while it is plugged into a power outlet may result in electric shock.

If you plan to leave the unit unused for an extended period, disconnect the power cord from the wall socket after turning off the power switch for the safety and the power conservation.

Notice for this monitor

This product is intended to be used in displaying and viewing digital images including those of digital mammography for review and analysis by trained medical practitioners.

Caution: Federal law (USA) restricts this device to sale by or on the order of a physician.

This product has been adjusted specifically for use in the region to which it was originally shipped. If the product is used outside the region, it may not operate as specified in the specifications.

This product may not be covered by warranty for uses other than those described in this manual.

The specifications noted in this manual are only applicable when the following are used:

- Power cords provided with the product
 - Signal cables specified by us
-

Only use optional products manufactured or specified by us with this product.

It takes about 30 minutes for the performance of electrical parts to stabilize. Please wait 30 minutes or more after the monitor power has been turned on or the monitor has recovered from the power saving mode, and then adjust the monitor.

It takes about a few minutes for the image quality to reach acceptable level. Please wait a few minutes or more after the monitor power has been turned on or the monitor has recovered from the power saving mode, and then view images for diagnosis.

Monitors should be set to a lower brightness to reduce changes in luminosity caused by long-term use and maintain a stable display.

When the screen image is changed after displaying the same image for extended periods of time, an afterimage may appear. Use the screen saver or power save function to avoid displaying the same image for extended periods of time.

Periodic cleaning is recommended to keep the monitor looking new and to prolong its operation lifetime. (Refer to “Cleaning” on the next page.)

The screen may have defective pixels or a small number of light dots on the screen. This is due to the characteristics of the panel itself, and is not a malfunction of the product.

The backlight of the LCD panel has a fixed lifetime. When the screen becomes dark or begins to flicker, please contact your dealer.

Do not press on the panel or edge of the frame strongly, as this may result in display malfunctions, such as interference patterns, etc. If pressure is continually applied to the panel, it may deteriorate or damage your panel. (If the pressure marks remain on the panel, leave the monitor with a black or white screen. The symptom may disappear.)

Do not scratch or press on the panel with any sharp objects, as this may result in damage to the panel. Do not attempt to brush with tissues as this may scratch the panel.

When the monitor is cold and brought into a room or the room temperature goes up quickly, dew condensation may occur on the interior and exterior surfaces of the monitor. In that case, do not turn the monitor on. Instead wait until the dew condensation disappears, otherwise it may cause some damage to the monitor.

Cleaning

Attention

- Chemicals such as alcohol and antiseptic solution may cause gloss variation, tarnishing, and fading of the cabinet, panel, half-silvered mirror, or polarized glasses and also quality deterioration of the image.
 - Never use any thinner, benzene, wax, and abrasive cleaner, which may damage the cabinet, panel, half-silvered mirror, or polarized glasses.
-

The stains on the cabinet, panel, half-silvered mirror, and polarized glasses surface can be removed by using the provided ScreenCleaner.

To use the monitor comfortably

- An excessively dark or bright screen may affect your eyes. Adjust the brightness of the monitor according to the environmental conditions.
- Staring at the monitor for a long time tires your eyes. Take a 10-minute rest every hour.
- If you become fatigued or experience discomfort while viewing 3D images, stop using the monitor.

CONTENTS

Cover	1
 PRECAUTIONS.....	3
Notice for this monitor	7
CONTENTS.....	9
Chapter 1 Introduction	10
1-1. Package Contents	10
1-2. Utility Disk.....	10
● Disk contents and software overview	10
● To use RadiCS LE or ScreenManager Pro for Medical.....	10
1-3. Basic Operation and Functions.....	11
Chapter 2 Basic Operations.....	12
Chapter 3 Troubleshooting	13
Chapter 4 Specifications	14

Chapter 1 Introduction

Thank you very much for choosing an EIZO Monochrome Stereoscopic LCD Monitor.

1-1. Package Contents

Check that all the following items are included in the packaging box. If any items are missing or damaged, contact your local dealer.

- Monitor (Upper)
- Monitor (Lower)
- Half-silvered mirror
- Fall prevention cap×2
- Cable cover (Upper)
- Cable cover (Lower)
- Power cord × 2
- Digital signal cable(DVI) : DD200-DL × 2
- Digital signal cable(DisplayPort) : PP200 × 2
- EIZO USB cable : MD-C93 × 2
- Surface fastener and pad for fixing the sensor ×1 each
- Polarized Glasses (with case) ×2
- EIZO LCD Utility Disk (CD-ROM)
- User's Manual (this manual)
- Cleaning Kit "ScreenCleaner"
- Recycling Information

NOTE

- Please keep the packaging box and materials for future movement or transport of the monitor.

1-2. Utility Disk

An "EIZO LCD Utility Disk" (CD-ROM) is supplied with the monitor. The following table shows the disk contents and the overview of the software programs.

● Disk contents and software overview

The disk includes application software programs for adjustment, and User's Manual. Refer to "Readme.txt" file on the disk for software startup procedures or file access procedures.

Item	Overview
A "Readme.txt" file	
RadiCS LE (for Windows)	RadiCS LE is quality control software used to calibrate the monitor and manage the calibration history.
RadiCS Monitor File (for Windows)	This is the monitor setting file required when using RadiCS (Optional). For information about installing this file, see the RadiCS User's Manual.
ScreenManager Pro for Medical (for Windows)	A utility software program to control monitor adjustments from a PC using its mouse and keyboard.

● To use RadiCS LE or ScreenManager Pro for Medical

Refer to the corresponding User's Manual on the CD-ROM disk in order to install and use the software. When using this software, you will need to connect a PC to the monitor with the supplied USB cable.

1- 3. Basic Operation and Functions

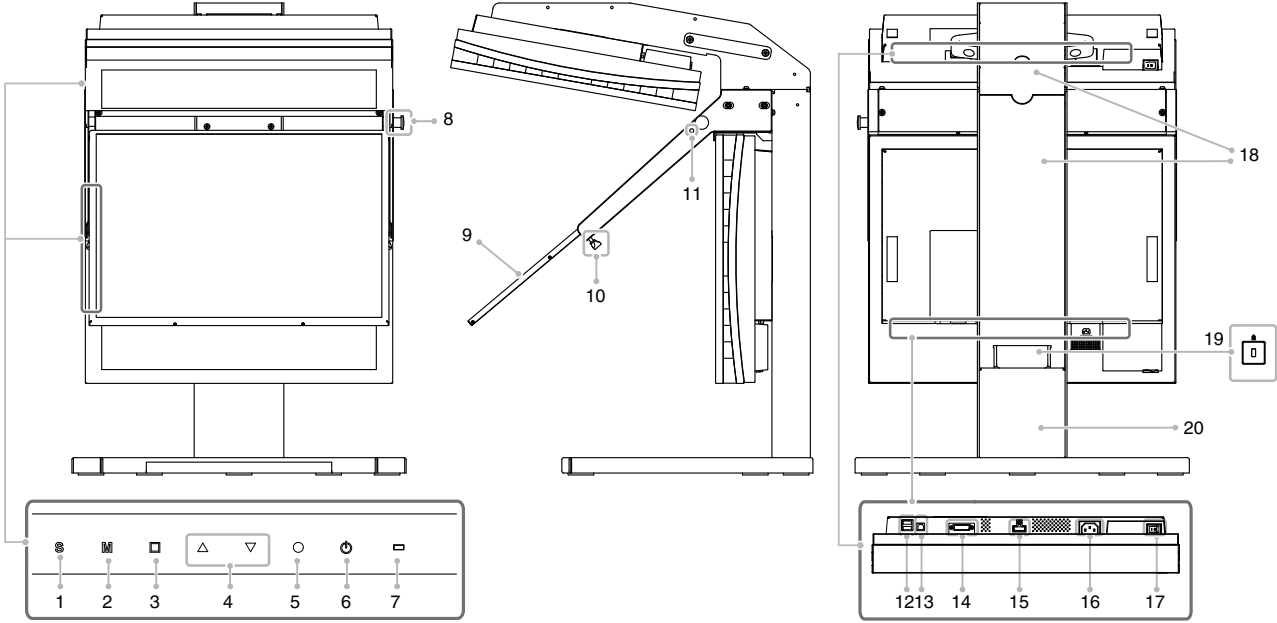

1	S switch	Switches input signals for display.
2	M switch	Allows you to switch the CAL Switch mode.
3	□ switch	Cancels the adjustment/setting or exit the adjustment menu.
4	△▽ switch*1	<ul style="list-style-type: none"> • Chooses an adjustment item or increases/decreases adjusted values for advanced adjustments using the Adjustment menu. • Adjusts the brightness..
5	○ switch*1	Displays the Adjustment menu, determines an item on the menu screen, and saves values adjusted.
6	⏻ switch	Turns the power on or off.
7	Power indicator	Indicates monitor's operation status. Green: Operating Orange: Power saving Off: Main Power Switch / Power Switch off
8	Lock lever	Allows you to fix the half-silvered mirror at the upper position when viewing two-dimensional images.
9	Half-silvered mirror	Reflects the upper monitor image and transmits the lower monitor image, and thus shows a layered image of the two monitors.
10	Angle adjustment screw*2	Allows you to adjust the angle of the half-silvered mirror.
11	Fall prevention cap	Prevents the half-silvered mirror from falling.
12	USB port (Down)	Connects a peripheral USB device.
13	USB port (Up)	Connects the USB cable to use the software that needs USB connection, or to use USB Hub function.
14	Input signal connectors	DVI-D Connector x 1
15	Input signal connectors	DisplayPort Connector x 1
16	Power connector	Connects the power cord.
17	Main Power switch	Turns the main power on or off.
18	Cable cover	Covers the monitor cables.
19	Security lock slot	Complies with Kensington's MicroSaver security system.

*1 It is locked to prevent the settings from being changed. If you need to change the settings, ask your dealer for advice.

*2 Do not touch the screw. If you adjust the angle, the image will not be displayed correctly.

Chapter 2 Basic Operations

Note

- In order to maximize the monitor life and to minimize luminance deterioration as well as power consumption, proceed the following:
 - Use the power saving function of the computer.
 - Turn the power to the monitor off when not in use.

1 Press (2 locations) to turn on the monitor.

The monitor's power indicator lights up green.

2 Turn on the PC.

The screen image appears.

When turning on the power for the first time after purchase, please switch input signals in accordance with your ports. Every time you press  at the bottom of the screen, input signals are changed.

If an image does not appear, refer to "Chapter 3 No-Picture Problem" (page 13) for additional advice.

Attention

- This product is equipped with DisplayPort input. However, there are cases that images are not properly displayed. If the images are not properly displayed, turn the main power off and then turn it back on. For more information about the compatibility between this product's DisplayPort and graphics boards, please refer to our website.
<http://www.eizo.com>
- Turn off the monitor and PC after using them.
- For the maximum power saving, it is recommended that the Power button be turned off. Turning off the main power switch completely shuts off power supply to the monitor.

3 Start up the three-dimensional image viewer. Display the image for the right eye on the upper monitor and the image for the left eye on the lower monitor.

4 Put on the polarized glasses and view the image from directly in front of the monitor. Do not tilt your head to either the left or right while viewing the image.

Attention

- Do not adjust the brightness.
- Viewing from an angle may distort images.
- Head-tilt to the left or the right may generate double images.
- The optimal viewing distance depends on the image acquisition conditions. Please contact your imaging equipment manufacturer for details on the optimal viewing distance.
- If an image does not appear, refer to "Chapter 3 No-Picture Problem" (page 13) for additional advice.

Note : For viewing a two-dimensional image

- When viewing two-dimensional images, push the half-silvered mirror upward while maintaining its angle, raise it along the grooves, and push it to the end until it is locked with a clicking sound, as shown in the illustration below.

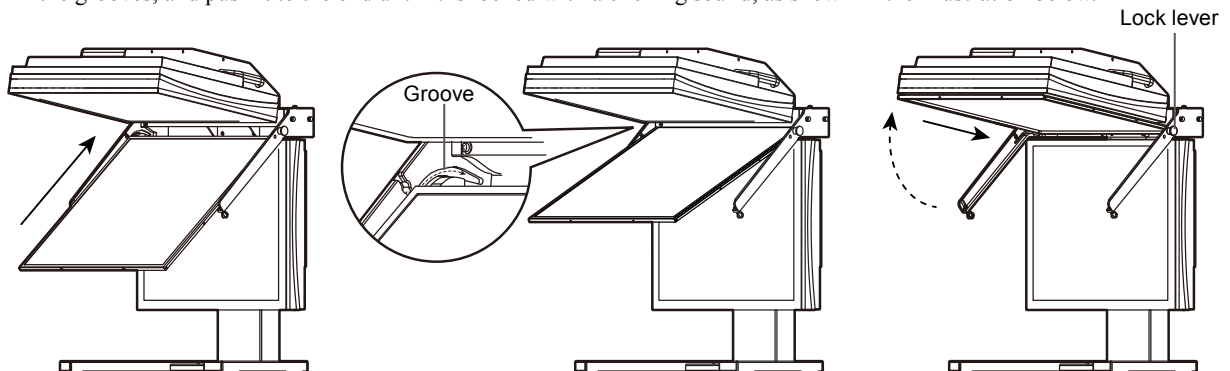

To view a three-dimensional image, pull the lock lever and return the mirror to its original position.

Chapter 3 Troubleshooting

If a problem still remains after applying the suggested remedies, contact your local dealer.

Problems	Possible cause and remedy
<p>1. No picture</p> <ul style="list-style-type: none"> Power indicator does not light. <hr/> <ul style="list-style-type: none"> Power indicator lights green. Power indicator lights orange. 	<ul style="list-style-type: none"> Check whether the power cord is connected correctly. Turn off the main power, and then turn it on again a few minutes later. Turn the main power switch on. Press ⏻. <hr/> <ul style="list-style-type: none"> Switch the input signal with S. Operate the mouse or keyboard. Check whether the PC is turned on.
<p>2. The message below appears.</p> <ul style="list-style-type: none"> This message appears when no signal is input. Example: <div data-bbox="277 730 671 985" data-label="Image"> <p>The screenshot shows a black background with white text. At the top, it says 'No Signal'. Below that is a small icon of a DisplayPort connector, followed by 'DisplayPort'. Underneath, it lists 'fH: 0.0kHz' and 'fV: 0.0Hz'. At the bottom, it says 'Check the input signal.'.</p> </div> <hr/> <ul style="list-style-type: none"> The message shows that the input signal is out of the specified frequency range. (Such signal frequency is displayed in red.) Example: <div data-bbox="277 1120 671 1429" data-label="Image"> <p>The screenshot shows a black background with white text. At the top, it says 'Signal Error'. Below that is a small icon of a DVI connector, followed by 'DVI Digital'. Underneath, it lists 'fD: 100.0MHz', 'fH: 100.0kHz', and 'fV: 70.0Hz'. At the bottom, it says 'Check the input signal.'.</p> </div>	<p>This message appears when the signal is not input correctly even when the monitor functions properly.</p> <ul style="list-style-type: none"> The message shown left may appear, because some PCs do not output the signal soon after power-on. Check whether the PC is turned on. Check whether the signal cable is connected properly. Switch the input signal with S. <hr/> <ul style="list-style-type: none"> Check whether the signal setting of your PC matches the resolution and the vertical frequency settings for the monitor. Reboot the PC. Select an appropriate display mode using the graphics board's utility. Refer to the manual of the graphics board for details. <p>fD : Dot Clock (Displayed only when the digital signal inputs) fH : Horizontal Frequency fV : Vertical Frequency</p>
<p>3. Double images appear on the monitor.</p>	<ul style="list-style-type: none"> Check whether there is nothing placed on the monitor. If anything is put on the monitor, the image will not be displayed correctly. Check whether you are viewing the image from the front. Check whether your head does not tilt to the left or right. Make sure that you are viewing the image from directly in front of the monitor.
<p>4. Images appear incorrectly.</p>	<ul style="list-style-type: none"> Attempt to exchange the image for the left eye with that for the right eye. Check whether the screws for connecting the upper and lower monitors as well as the other screws are not loosened. Otherwise, ask your dealer for advice.

Chapter 4 Specifications

Dimensions		524.0 mm (20.6 inch) × 734.0 mm (28.9 inch) × 566.0 mm (22.3 inch)
Mass		Approx. 24.5 kg (54 lbs.)
Environmental Conditions	Temperature	Operating : 0 °C - 35 °C (32 °F - 95 °F) Transportation/Storage: -20 °C - 60 °C (-4 °F - 140 °F)
	Humidity	Operating: 20% - 80% R.H. (no condensation) Transportation/Storage: 10% - 80% R.H. (no condensation)
	Pressure	Operating: 700 to 1,060 hPa Transportation/Storage: 200 to 1,060 hPa

The following are the specifications for a single monitor.

LCD Panel	Size	21.3-inch (540 mm) TFT Monochrome LDC panel
	Surface treatment	Glare
	Surface hardness	3H
	Viewing angle	Viewing angle : Horizontal 170°, Vertical 170° (CR:10 or more)
	Dot Pitch	0.165 mm
	Response Time	Approx. 50 ms
Horizontal Scan Frequency		31-135 kHz
Vertical Scan Frequency		19 ~ 61Hz (VGA TEXT : 69 ~ 71Hz / QSXGA : 19 ~ 51Hz)
Resolution		5M pixels (Portrait: 2048 × 2560 dots (H × V))
Max. Dot Clock		290 MHz
Gray Scale		4096 steps of 13771 steps (12 bit signal input, [Sub Pixel Drive] : "Off") 1024 steps of 3571 steps (10 bit signal input, [Sub Pixel Drive] : "On")
Recommended Brightness		Upper monitor : 400 cd/m ² Lower monitor : 500 cd/m ²
Display Area (H × V)		422.4 mm × 337.9 mm
Power Supply (Per one monitor)		100-120 VAC ±10%, 50/60Hz 1.1 – 0.9 A 200-240 VAC ±10%, 50/60Hz 0.6 – 0.5 A
Power Consumption (Per one monitor)	Screen Display On	100W or less (with USB load) 90W or less (without USB load)
	Power saving mode	1.0W or less (for DVI-D single signal input, without USB load, [Input Signal] : "Manual")
	Power switch Off	0.8W or less (without USB load)
	Main Power switch Off	0W
Input Signal Connector		DVI-D connector (Applicable to HDCP) × 1
		DisplayPort (Standard V1.1a, applicable to HDCP) × 1
Digital Signal (DVI) Transmission System		TMDS (Single Link/Dual Link)
Plug & Play		Digital (DVI-D) : VESA DDC 2B / EDID structure 1.3 Digital (DisplayPort) : VESA DisplayPort / EDID structure 1.4
Dimensions		480.0 mm (18.9 inch) × 388.0 mm (15.3 inch) × 88.0mm (3.46 inch)
Mass		Approx. 7.1 kg (15.7 lbs.)
USB	Standard	USB Specification Revision 2.0
	Port	Upstream port × 1, Downstream port × 2
	Communication Speed	480 Mbps (high), 12 Mbps (full), 1.5 Mbps (low)
	Supply current	Downstream: Max. 500mA/1 port

Classification of Equipment	Type of protection against electric shock : Class I EMC class: EN60601-1-2:2007 Group 1 Class B Classification of medical device (MDD 93/42/EEC) : Class I Mode of operation : Continuous IP Class : IPX0
-----------------------------	---

Main default settings (factory settings)

CAL Switch	1-DICOM
Power Save	On
Input Selection	Manual
Key Lock	Menu
Logo	Off
Menu Position	Center
Language	English
Signal Selection	Dual Link
Orientation	Landscape

Outside Dimensions

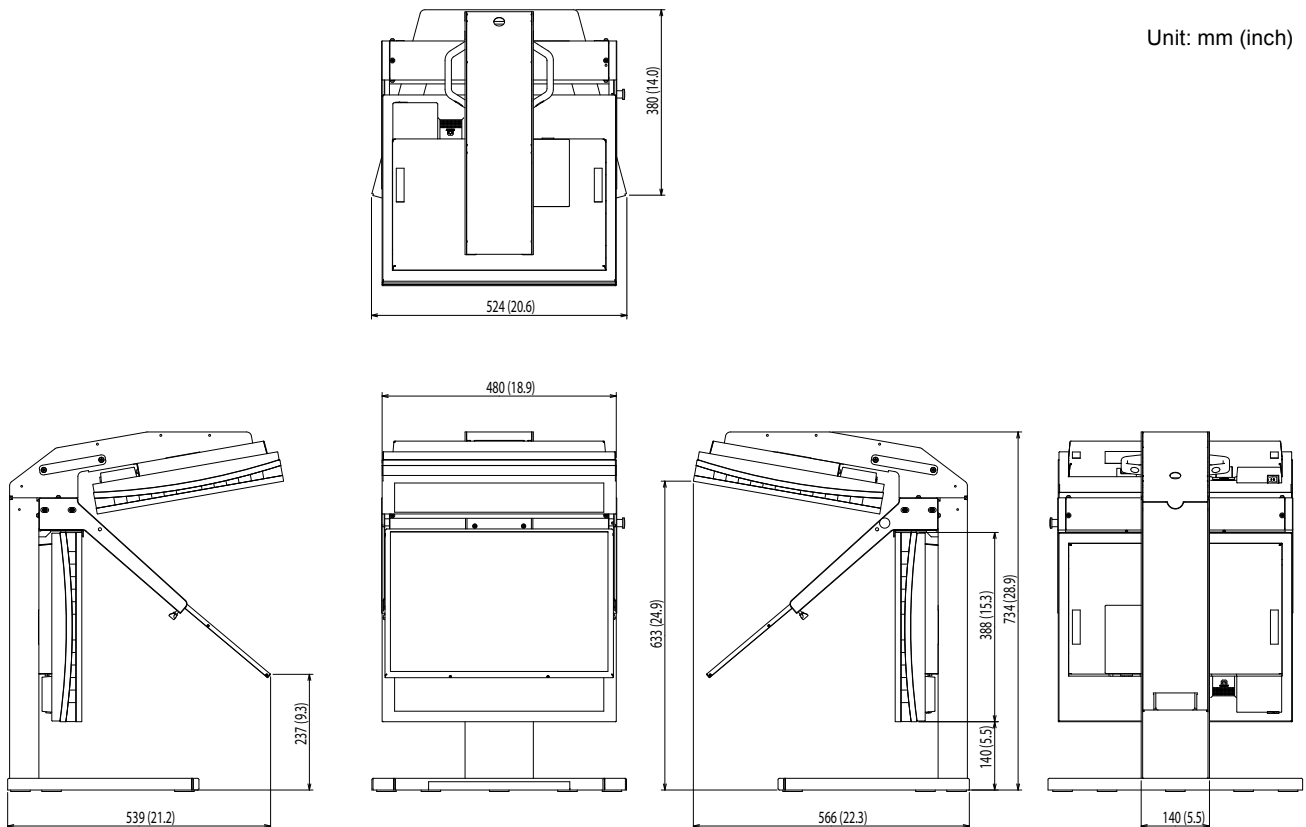

Accessories List

Monitor Quality Control Software Kit	EIZO "RadiCS UX1" Ver.3.5.1 or later
Network QC Management Software	EIZO "RadiNET Pro" Ver.3.5.1 or later
Signal Cable	PP200
Polarized Glasses (paper)	PLP-1

Refer to Web site of EIZO Corporation for the latest information about supported graphics card (<http://www.eizo.com>).

LIMITED WARRANTY

EIZO Corporation (hereinafter referred to as “EIZO”) and distributors authorized by EIZO (hereinafter referred to as the “Distributors”) warrant, subject to and in accordance with the terms of this limited warranty (hereinafter referred to as the “Warranty”), to the original purchaser (hereinafter referred to as the “Original Purchaser”) who purchased the product specified in this document (hereinafter referred to as the “Product”) from EIZO or Distributors, that EIZO and Distributors shall, at their sole discretion, either repair or replace the Product at no charge if the Original Purchaser becomes aware within the Warranty Period (defined below) that (i) the Product malfunctions or is damaged in the course of normal use of the Product in accordance with the description in the instruction manual attached to the Product (hereinafter referred to as the “User’s Manual”), or (ii) the LCD panel and brightness of the Product cannot maintain the recommended brightness specified in the User’s Manual in the course of normal use of the Product in accordance with the description of the User’s Manual.

The period of this Warranty is five (5) years from the date of purchase of the Product (hereinafter referred to as the “Warranty Period”), provided that the Warranty Period for the LCD panel is limited to five (5) years from the date of purchase of the Product subject to the usage time being less than or equal to 30,000 hours. The brightness of the Product shall be warranted only if the Product has been used within the recommended brightness of described in the User’s Manual and the Warranty Period for the brightness is limited to five (5) years from the date of purchase of the Product subject to the usage time being less than or equal to 30,000 hours. EIZO and Distributors shall bear no liability or obligation with regard to the Product in relation to the Original Purchaser or any third parties other than as provided under this Warranty.

EIZO and Distributors will cease to hold or store any parts of the Product upon expiration of seven (7) years after the production of such parts is discontinued. In repairing the monitor, EIZO and Distributors will use renewal parts which comply with our QC standards.

The Warranty is valid only in the countries or territories where the Distributors are located. The Warranty does not restrict any legal rights of the Original Purchaser.

Notwithstanding any other provision of this Warranty, EIZO and Distributors shall have no obligation under this Warranty whatsoever in any of the cases as set forth below:

- (a) Any defect of the Product caused by freight damage, modification, alteration, abuse, misuse, accident, incorrect installation, disaster, faulty maintenance and/or improper repair by third party other than EIZO and Distributors;
- (b) Any incompatibility of the Product due to possible technical innovations and/or regulations;
- (c) Any deterioration of the sensor;
- (d) Any deterioration of display performance caused by the deterioration of expendable parts such as the LCD panel and/or backlight, etc. (e.g. changes in color, changes in color uniformity, defects in pixels including burnt pixels, etc.);
- (e) Any deterioration of the Product caused by the use at higher brightness than the recommended brightness described in the User’s Manual;
- (f) Any defect of the Product caused by external equipment;
- (g) Any defect of the Product on which the original serial number has been altered or removed;
- (h) Any normal deterioration of the product, particularly that of consumables, accessories, and/or attachments (e.g. buttons, rotating parts, cables, User’s Manual, etc.); and
- (i) Any deformation, discoloration, and/or warp of the exterior of the product including that of the surface of the LCD panel.

To obtain service under the Warranty, the Original Purchaser must deliver the Product, freight prepaid, in its original package or other adequate package affording an equal degree of protection, assuming the risk of damage and/or loss in transit, to the local Distributor. The Original Purchaser must present proof of purchase of the Product and the date of such purchase when requesting services under the Warranty.

The Warranty Period for any replaced and/or repaired product under this Warranty shall expire at the end of the original Warranty Period.

EIZO OR DISTRIBUTORS ARE NOT RESPONSIBLE FOR ANY DAMAGE TO, OR LOSS OF, DATA OR OTHER INFORMATION STORED IN ANY MEDIA OR ANY PART OF ANY PRODUCT RETURNED TO EIZO OR DISTRIBUTORS FOR REPAIR.

EIZO AND DISTRIBUTORS MAKE NO FURTHER WARRANTIES, EXPRESSED OR IMPLIED, WITH RESPECT TO THE PRODUCT AND ITS QUALITY, PERFORMANCE, MERCHANTABILITY OR FITNESS FOR ANY PARTICULAR USE. IN NO EVENT SHALL EIZO OR DISTRIBUTORS BE LIABLE FOR ANY INCIDENTAL, INDIRECT, SPECIAL, CONSEQUENTIAL OR OTHER DAMAGE WHATSOEVER (INCLUDING, WITHOUT LIMITATION, DAMAGES FOR LOSS OF PROFIT, BUSINESS INTERRUPTION, LOSS OF BUSINESS INFORMATION, OR ANY OTHER PECUNIARY LOSS) ARISING OUT OF THE USE OR INABILITY TO USE THE PRODUCT OR IN ANY CONNECTION WITH THE PRODUCT, WHETHER BASED ON CONTRACT, TORT, NEGLIGENCE, STRICT LIABILITY OR OTHERWISE, EVEN IF EIZO OR DISTRIBUTORS HAVE BEEN ADVISED OF THE POSSIBILITY OF SUCH DAMAGES. THIS EXCLUSION ALSO INCLUDES ANY LIABILITY WHICH MAY ARISE OUT OF THIRD PARTY CLAIMS AGAINST THE ORIGINAL PURCHASER. THE ESSENCE OF THIS PROVISION IS TO LIMIT THE POTENTIAL LIABILITY OF EIZO AND DISTRIBUTORS ARISING OUT OF THIS LIMITED WARRANTY AND/OR SALES.

EMC Information

Essential performance of RadiForce series is to display images and operate functions normally.



CAUTION

The RadiForce series requires special precautions regarding EMC and need to be installed, put into service and used according to the following information.

Do not use any cables other than the cables that provided or specified by us.

Using other cables may cause the increase of emission or decrease of immunity.

Do not put any portable and mobile RF communications equipment close to the RadiForce series. Doing so may affect the RadiForce series.

The RadiForce series should not be used adjacent to or stacked with other equipment. If adjacent or stacked use is necessary, the equipment or system should be observed to verify normal operation in the configuration in which it will be used.

Anyone who connects additional equipment to the signal input part or signal output parts, configuring a medical system, is responsible that the system complies with the requirements of IEC/EN60601-1-2.

Guidance and manufacturer's declaration - electromagnetic emissions		
The RadiForce series is intended for use in the electromagnetic environment specified below. The customer or the user of the RadiForce series should assure that it is used in such an environment.		
Emission test	Compliance	Electromagnetic environment - guidance
RF emissions CISPR11/EN55011	Group 1	The RadiForce series uses RF energy only for its internal function. Therefore, its RF emission are very low and are not likely to cause any interference in nearby electronic equipment.
RF emissions CISPR11/EN55011	Class B	The RadiForce series is suitable for use in all establishments, including domestic establishments and those directly connected to the public low-voltage power supply network that supplies buildings used for domestic purposes.
Harmonic emissions IEC/EN61000-3-2	Class D	
Voltage fluctuations / flicker emissions IEC/EN61000-3-3	Complies	

Guidance and manufacturer's declaration - electromagnetic immunity			
The RadiForce series is intended for use in the electromagnetic environment specified below. The customer or the user of the RadiForce series should assure that it is used in such an environment.			
Immunity test	IEC/EN60601 test level	Compliance level	Electromagnetic environment - guidance
Electrostatic discharge (ESD) IEC/EN61000-4-2	±6kV contact ±8kV air	±6kV contact ±8kV air	Floors should be wood, concrete or ceramic tile. If floors are covered with synthetic material, the relative humidity should be at least 30%.
Electrical fast transient / burst IEC/EN61000-4-4	±2kV for power supply lines ±1kV for input/output lines	±2kV for power supply lines ±1kV for input/output lines	Mains power quality should be that of a typical commercial or hospital environment.
Surge IEC/EN61000-4-5	±1kV line(s) to line(s) ±2kV line(s) to earth	±1kV line(s) to line(s) ±2kV line(s) to earth	Mains power quality should be that of a typical commercial or hospital environment.
Voltage dips, short interruptions and voltage variations on power supply input lines IEC/EN61000-4-11	<5% U _T (>95% dip in U _T) for 0.5 cycle 40% U _T (60% dip in U _T) for 5 cycles 70% U _T (30% dip in U _T) for 25 cycles <5% U _T (>95% dip in U _T) for 5sec	<5% U _T (>95% dip in U _T) for 0.5 cycle 40% U _T (60% dip in U _T) for 5 cycles 70% U _T (30% dip in U _T) for 25 cycles <5% U _T (>95% dip in U _T) for 5sec	Mains power quality should be that of a typical commercial or hospital environment. If the user of the RadiForce series requires continued operation during power mains interruptions, it is recommended that the RadiForce series be powered from an uninterruptible power supply or a battery.
Power frequency (50/60Hz) magnetic field IEC/EN61000-4-8	3A/m	3A/m	Power frequency magnetic fields should be at levels characteristic of a typical location in a typical commercial or hospital environment.
NOTE U _T is the a.c. mains voltage prior to application of the test level.			

Guidance and manufacturer's declaration - electromagnetic immunity			
The RadiForce series is intended for use in the electromagnetic environment specified below. The customer or the user of the RadiForce series should assure that it is used in such an environment.			
Immunity test	IEC/EN60601 test level	Compliance level	Electromagnetic environment - guidance
Conducted RF IEC/EN61000-4-6 Radiated RF IEC/EN61000-4-3	3Vrms 150kHz to 80MHz 3V/m 80MHz to 2.5GHz	3Vrms 3V/m	<p>Portable and mobile RF communications equipment should be used no closer to any part of the RadiForce series, including cables, than the recommended separation distance calculated from the equation applicable to the frequency of the transmitter.</p> <p>Recommended Separation distance</p> $d = 1.2 \sqrt{P}$ $d = 1.2 \sqrt{P}, 80\text{MHz to } 800\text{MHz}$ $d = 2.3 \sqrt{P}, 800\text{MHz to } 2.5\text{GHz}$ <p>Where "P" is the maximum output power rating of the transmitter in watts (W) according to the transmitter manufacturer and "d" is the recommended separation distance in meters (m).</p> <p>Field strengths from fixed RF transmitters, as determined by an electromagnetic site survey^a, should be less than the compliance level in each frequency range^b.</p> <p>Interference may occur in the vicinity of equipment marked with the following symbol.</p> 
NOTE 1 At 80 MHz and 800 MHz, the higher frequency range applies.			
NOTE 2 These guidelines may not apply in all situations. Electromagnetic propagation is affected by absorption and reflection from structures, objects and people.			
^a Field strengths from fixed transmitters, such as base stations for radio (cellular/cordless) telephones and land mobile radios, amateur radio, AM and FM radio broadcast and TV broadcast cannot be predicted theoretically with accuracy. To assess the electromagnetic environment due to fixed RF transmitters, an electromagnetic site survey should be considered. If the measured field strength in the location in which the RadiForce series is used exceeds the applicable RF compliance level above, the RadiForce series should be observed to verify normal operation. If abnormal performance is observed, additional measures may be necessary, such as reorienting or relocating the RadiForce series.			
^b Over the frequency range 150 kHz to 80 MHz, field strengths should be less than 3 V/m.			

Recommended separation distances between portable and mobile RF communications equipment and the RadiForce Series

The RadiForce series is intended for use in an electromagnetic environment in which radiated RF disturbances are controlled. The customer or the user of the RadiForce series can help prevent electromagnetic interference by maintaining a minimum distance between portable and mobile RF communications equipment (transmitters) and the RadiForce series as recommended below, according to the maximum output power of the communications equipment.

Rated maximum output power of transmitter W	Separation distance according to frequency of transmitter m		
	150kHz to 80MHz $d = 1.2 \sqrt{P}$	80MHz to 800MHz $d = 1.2 \sqrt{P}$	800MHz to 2.5GHz $d = 2.3 \sqrt{P}$
0.01	0.12	0.12	0.23
0.1	0.38	0.38	0.73
1	1.2	1.2	2.3
10	3.8	3.8	7.3
100	12	12	23

For transmitters rated at a maximum output power not listed above, the recommended separation distance “d” in meters (m) can be estimated using the equation applicable to the frequency of the transmitter, where “P” is the maximum output power rating of the transmitter in watts (W) according to the transmitter manufacturer.

NOTE 1 At 80 MHz and 800 MHz, the separation distance for the higher frequency range applies.

NOTE 2 These guidelines may not apply in all situations. Electromagnetic propagation is affected by absorption and reflection from structures, objects and people.

Cable length		
Power Cord :	Accessory	2.0m
Signal Cable (DD200-DL) :	Accessory	2.0m
Signal Cable (PP200) :	Accessory	2.0m
USB Cable (MD-C93) :	Accessory	1.8m

关于电子信息产品污染控制标识



本标识根据「电子信息产品污染控制管理办法」，适用于在中华人民共和国销售的电子信息产品。标识中央的数字为环保使用期限的年数。只要您遵守该产品相关的安全及使用注意事项，在自制造日起算的年限内，不会产生对环境污染或人体及财产的影响。上述标识粘贴在机器背面。

• 有毒有害物质或元素的名称及含量

部件名称	有毒有害物质或元素					
	铅 (Pb)	汞 (Hg)	镉 (Cd)	六价铬 (Cr (VI))	多溴联苯 (PBB)	多溴二苯醚 (PBDE)
印刷电路板	×	○	○	○	○	○
机箱	○	○	○	○	○	○
液晶显示器	×	×	○	○	○	○
其他	×	○	○	○	○	○

○：表示该有毒有害物质在该部件所有均质材料中的含量均在 SJ/T 11363-2006 规定的限量要求以下。
×：表示该有毒有害物质至少在该部件的某一均质材料中的含量超出 SJ/T 11363-2006 规定的限量要求。
(企业可在此处，根据实际情况对上表中打“×”的技术原因进行进一步说明)



EIZO Corporation

153 Shimokashiwano, Hakusan, Ishikawa 924-8566 Japan
Phone: +81 76 277 6792 Fax: +81 76 277 6793

艺卓显像技术(苏州)有限公司

中国苏州市苏州工业园区展业路8号中新科技工业坊5B
Phone: +86 512 6252 0100 Fax: +86 512 6252 1508

EIZO株式会社

〒924-8566 石川県白山市下柏野町 153 番地

EC REP

EIZO GmbH

Siemensallee 84, 76187 Karlsruhe, Germany
Phone: +49 721 20321 0 Fax: +49 721 20321 471

<http://www.eizo.com>
<http://www.eizo.co.jp>

Copyright © 2010-2013 EIZO Corporation All rights reserved.

4th Edition-September, 2013 Printed in Japan.

00NOL610D1
(U.M-GS521-ST)