

# User's Manual

# FlexScan<sup>®</sup> S2001W S2201W

Color LCD Monitor

## Important

Please read this User's Manual and Setup Manual (separate volume) carefully to familiarize yourself with safe and effective usage.

## PRECAUTIONS

## CONTENTS

### Chapter 1 Features and Overview

- 1-1 Features
- 1-2 Buttons and Indicators
- 1-3 Functions and Basic Operation

### Chapter 2 Settings and Adjustments

- 2-1 Utility Disk
- 2-2 Screen Adjustment
- 2-3 Color Adjustment
- 2-4 Off Timer/Power Saving Settings
- 2-5 Screen Size Selection
- 2-6 Power Indicator/EIZO Logo Display Setting
- 2-7 Locking Buttons
- 2-8 Disabling DDC/CI Communication
- 2-9 Setting Adjustment Menu Display
- 2-10 Setting Orientation
- 2-11 Viewing Information/Setting Language
- 2-12 Setting BrightRegulator
- 2-13 Resumption of Default Setting

### Chapter 3 Connecting Cables

- 3-1 Connecting Two PCs to the Monitor
- 3-2 Connecting Peripheral USB Devices

### Chapter 4 Troubleshooting

### Chapter 5 Reference

- 5-1 Attaching an Arm
- 5-2 Cleaning
- 5-3 Specifications
- 5-4 Glossary
- 5-5 Preset Timing





## How to Setup

Please read the Setup Manual (separate volume)



## SAFETY SYMBOLS

This manual uses the safety symbols below. They denote critical information. Please read them carefully.

 <p><b>WARNING</b> Failure to abide by the information in a WARNING may result in serious injury and can be life threatening.</p>	 <p><b>CAUTION</b> Failure to abide by the information in a CAUTION may result in moderate injury and/or property or product damage.</p>
	<p>Indicates a prohibited action.</p>
	<p>Indicates a mandatory action that must be followed.</p>

---

Copyright© 2007 EIZO NANA O CORPORATION All rights reserved.

No part of this manual may be reproduced, stored in a retrieval system, or transmitted, in any form or by any means, electronic, mechanical, or otherwise, without the prior written permission of EIZO NANA O CORPORATION. EIZO NANA O CORPORATION is under no obligation to hold any submitted material or information confidential unless prior arrangements are made pursuant to EIZO NANA O CORPORATION's receipt of said information. Although every effort has been made to ensure that this manual provides up-to-date information, please note that EIZO monitor specifications are subject to change without notice.

---

ENERGY STAR is a U.S. registered mark.

Apple and Macintosh are registered trademarks of Apple Inc.

VGA is a registered trademark of International Business Machines Corporation.

DPMS and DDC/CI are trademarks and VESA is a registered trademark of Video Electronics Standards Association.

Windows is a registered trademark of Microsoft Corporation.

PowerManager is a trademark of EIZO NANA O CORPORATION.

FlexScan, ScreenManager, i•Sound and EIZO are registered trademarks of EIZO NANA O CORPORATION in Japan and other countries.

As an ENERGY STAR® Partner, EIZO NANA O CORPORATION has determined that this product meets the ENERGY STAR guidelines for energy efficiency.



Product specification may vary with sales areas.

Confirm the specification in the manual written in language of the region of purchase.

# ⚠ PRECAUTIONS

## IMPORTANT

- This product has been adjusted specifically for use in the region to which it was originally shipped. If the product is used outside the region, it may not operate as specified in the specifications.
- To ensure personal safety and proper maintenance, please read carefully this section and the caution statements on the monitor.

## [Location of Caution Statement]

Ex. S2201W

### Example of height adjustable stand

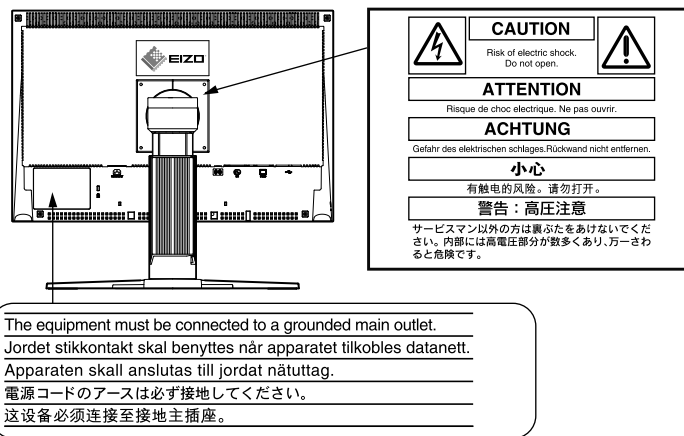

## ⚠ WARNING

**If the unit begins to emit smoke, smells like something is burning, or makes strange noises, disconnect all power connections immediately and contact your dealer for advice.**

Attempting to use a malfunctioning unit may result in fire, electric shock, or equipment damage.

**Do not open the cabinet or modify the unit.**

Opening the cabinet or modifying the unit may result in fire, electric shock, or burn.



**Refer all servicing to qualified service personnel.**

Do not attempt to service this product yourself as opening or removing covers may result in fire, electric shock, or equipment damage.

**Keep small objects or liquids away from the unit.**

Small objects accidentally falling through the ventilation slots into the cabinet or spillage into the cabinet may result in fire, electric shock, or equipment damage.

If an object or liquid falls/spills into the cabinet, unplug the unit immediately. Have the unit checked by a qualified service engineer before using it again.



## WARNING

---

### **Place the unit at the strong and stable place.**

A unit placed on an inadequate surface may fall and result in injury or equipment damage. If the unit falls, disconnect the power immediately and ask your dealer for advice. Do not continue using a damaged unit. Using a damaged unit may result in fire or electric shock.

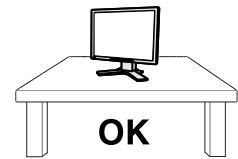

### **Set the unit in an appropriate location.**

Not doing so may result in fire, electric shock, or equipment damage.

- Do not place outdoors.
- Do not place in the transportation system (ship, aircraft, trains, automobiles, etc.)
- Do not place in a dusty or humid environment.
- Do not place in a location where the steam comes directly on the screen.
- Do not place near heat generating devices or a humidifier.

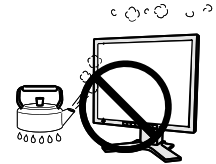

### **To avoid danger of suffocation, keep the plastic packing bags away from babies and children.**

---

### **Use the enclosed power cord and connect to the standard power outlet of your country.**

Be sure to remain within the rated voltage of the power cord.

Not doing so may result in fire or electric shock.

### **To disconnect the power cord, grasp the plug firmly and pull.**

Tugging on the cord may damage and result in fire or electric shock.



### **The equipment must be connected to a grounded main outlet.**

Failure to do so may result in fire or electric shock.



### **Use the correct voltage.**

- The unit is designed for use with a specific voltage only. Connection to another voltage than specified in this User's Manual may cause fire, electric shock, or equipment damage.
  - Do not overload your power circuit, as this may result in fire or electric shock.
-

## **WARNING**

---

### **Handle the power cord with care.**

- Do not place the cord underneath the unit or other heavy objects.
- Do not pull on or tie the cord.

If the power cord becomes damaged, stop using it. Use of a damaged cord may result in fire or electric shock.



---

### **Never touch the plug and power cord if it begins to thunder.**

Touching them may result in electric shock.



---

### **When attaching an arm stand, please refer to the user's manual of the arm stand and install the unit securely.**

Not doing so may cause the unit to become unattached, which may result in injury or equipment damage. When the unit is dropped, please ask your dealer for advice. Do not continue using a damaged unit. Using a damaged unit may result in fire or electric shock. When reattaching the tilt stand, please use the same screws and tighten them securely.

---

### **Do not touch a damaged LCD panel directly with bare hands.**

The liquid crystal that may leak from the panel is poisonous if it enters the eyes or mouth. If any part of the skin or body comes in direct contact with the panel, please wash thoroughly. If some physical symptoms result, please consult your doctor.



---

### **Lamps contain mercury, dispose according to local, state or federal laws.**

---

## CAUTION

---

### **Handle with care when carrying the unit.**

Disconnect the power cord and cables when moving the unit. Moving the unit with the cord attached is dangerous. It may result in injury.

---

### **When handling the unit, grip the bottom of the unit firmly with both hands ensuring the panel faces outward before lifting.**

Dropping the unit may result in injury or equipment damage.

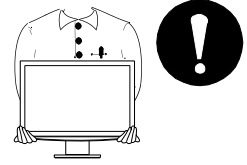

### **Do not block the ventilation slots on the cabinet.**

- Do not place any objects on the ventilation slots.
- Do not install the unit in a closed space.
- Do not use the unit laid down or upside down.

Blocking the ventilation slots prevents proper airflow and may result in fire, electric shock, or equipment damage.



### **Do not touch the plug with wet hands.**

Doing so may result in electrical shock.



### **Use an easily accessible power outlet.**

This will ensure that you can disconnect the power quickly in case of a problem.

---

### **Periodically clean the area around the plug.**

Dust, water, or oil on the plug may result in fire.

---

### **Unplug the unit before cleaning it.**

Cleaning the unit while it is plugged into a power outlet may result in electric shock.

---

**If you plan to leave the unit unused for an extended period, disconnect the power cord from the wall socket after turning off the power button for the safety and the power conservation.**

---

## LCD Panel

---

In order to suppress the luminosity change by long-term use and to maintain the stable luminosity, use of a monitor in lower brightness is recommended.

---

The LCD panel is manufactured using high-precision technology. However, note that the appearance of any missing pixels or lit pixels does not indicate damage to the LCD monitor.

Percentage of effective pixels: 99.9994% or higher.

---

The backlight of the LCD panel has a fixed life span. When the screen becomes dark or begins to flicker, please contact your dealer.

---

Do not press on the panel or edge of the frame strongly, as this may result in the display malfunction, such as the interference patterns, etc. If pressure is continually applied to the LCD panel, it may deteriorate or damage your LCD panel. (If the pressure marks remain on the LCD panel, leave the monitor with a white or black screen. The symptom may disappear.)

---

Do not scratch or press on the panel with any sharp objects, such as a pencil or pen as this may result in damage to the panel. Do not attempt to brush with tissues as this may scratch the LCD panel.

---

When the monitor is cold and brought into a room or the room temperature goes up quickly, dew condensation may occur inside and outside the monitor. In that case, do not turn the monitor on and wait until dew condensation disappears, otherwise it may cause damage to the monitor.

---

When the screen image is changed after displaying the same image for extended periods of time, an afterimage may appear. Use the screen saver or timer to avoid displaying the same image for extended periods of time.

---

---

## To use the monitor comfortably

---

An excessively dark or bright screen may affect your eyes. Adjust the brightness of the monitor according to the environmental conditions.

---

Staring at the monitor for a long time tires your eyes. Take a 10-minute rest every hour.

---

---

# CONTENTS

<b>PRECAUTIONS</b> .....	<b>1</b>	<b>2-7 Locking Buttons</b> .....	<b>21</b>
LCD Panel.....	5	• To lock operation [Adjustment Lock].....	21
To use the monitor comfortably .....	5	<b>2-8 Disabling DDC/CI Communication</b> .....	<b>22</b>
<b>Chapter 1 Features and Overview</b> .....	<b>7</b>	• To disable DDC/CI communication.....	22
<b>1-1 Features</b> .....	7	<b>2-9 Setting Adjustment Menu Display</b> .....	<b>22</b>
<b>1-2 Buttons and Indicators</b> .....	7	• To update menu settings	
<b>1-3 Functions and Basic Operation</b> .....	8	[Menu Size/Menu Position/Menu Off Timer/ Translucent].....	22
<b>Chapter 2 Settings and Adjustments</b> .....	<b>11</b>	<b>2-10 Setting Orientation</b> .....	<b>23</b>
<b>2-1 Utility Disk</b> .....	<b>11</b>	• To set the orientation of the Adjustment menu	
• Disk contents and software overview .....	11	[Orientation].....	23
• To use ScreenManager Pro for LCD .....	11	<b>2-11 Viewing Information/Setting Language</b> .....	<b>23</b>
<b>2-2 Screen Adjustment</b> .....	<b>12</b>	• To check settings, usage time, etc.	
<b>Digital Input</b> .....	12	[Information] .....	23
<b>Analog Input</b> .....	12	• To set a language to be displayed	
<b>2-3 Color Adjustment</b> .....	<b>15</b>	[Language] .....	23
<b>Simple adjustment [FineContrast mode]</b> .....	<b>15</b>	<b>2-12 Setting BrightRegulator</b> .....	<b>24</b>
• FineContrast Mode.....	15	• To set automatic brightness adjustment	
• To select FineContrast mode.....	15	[BrightRegulator] .....	24
<b>Advanced Adjustments [Adjustment menu]</b> .....	<b>16</b>	<b>2-13 Resumption of Default Setting</b> .....	<b>24</b>
• To select an appropriate mode for images .....	16	• To reset color adjustment [Reset].....	24
• To set/adjust color .....	17	• To reset all settings [Reset] .....	24
<b>2-4 Off Timer/Power Saving Settings</b> .....	<b>18</b>	<b>Chapter 3 Connecting Cables</b> .....	<b>25</b>
• To set monitor power-off time [Off Timer] .....	18	<b>3-1 Connecting Two PCs to the Monitor</b> .....	<b>25</b>
• To set monitor power-saving		• To set input signal selection [Input Signal] .....	26
[VESA DPMS/DVI DMPM].....	19	<b>3-2 Connecting Peripheral USB Devices</b> .....	<b>26</b>
<b>2-5 Screen Size Selection</b> .....	<b>20</b>	<b>Chapter 4 Troubleshooting</b> .....	<b>27</b>
• To change screen size [Screen Size].....	20	<b>Chapter 5 Reference</b> .....	<b>30</b>
• To adjust brightness of non-display area		<b>5-1 Attaching an Arm</b> .....	<b>30</b>
[Border Intensity] .....	20	<b>5-2 Cleaning</b> .....	<b>31</b>
<b>2-6 Power Indicator/EIZO Logo Display Setting</b>	<b>21</b>	<b>5-3 Specifications</b> .....	<b>32</b>
• To turn off the Power indicator while a screen is		<b>5-4 Glossary</b> .....	<b>38</b>
displayed [Power Indicator] .....	21	<b>5-5 Preset Timing</b> .....	<b>40</b>
• To display EIZO logo [EIZO Logo Appearing			
Function].....	21		



# Chapter 1 Features and Overview

Thank you very much for choosing an EIZO color LCD monitor.

## 1-1 Features

- 20.1 (S2001W) / 22.0 (S2201W) inch class wide screen format LCD
- Applicable to HDCP
- Stereo speakers
- Dual-input compliant (DVI-I and D-Sub mini 15-pin connectors)
- DVI digital input (TMDS) compliant
- Horizontal scan frequency, Vertical scan frequency and Resolution are as follows;

Horizontal scan frequency	Analog	24 - 82 kHz
	Digital	31 - 65 kHz
Vertical scan frequency	Analog	49 - 86 Hz
		49 - 76 Hz (1280 × 1024)
		49 - 61 Hz (1680 × 1050)
	Digital	59 - 61 Hz (VGA TEXT 69 - 71 Hz)
Resolution	1680 dots × 1050 lines	

- Compatible with frame synchronization mode 59 - 61 Hz  
\* Only if the [Full Screen] is selected from the <Screen Size>.
- Smoothing (soft - sharp) function for adjustment of enlarged images
- FineContrast mode to allow the best mode for screen display
- The utility software “ScreenManager Pro for LCD” (for Windows) to control the monitor from a PC with mouse/keyboard is included (refer to the EIZO LCD Utility Disk).
- BrightRegulator function incorporate
- Self AutoAdjust function incorporate

## 1-2 Buttons and Indicators

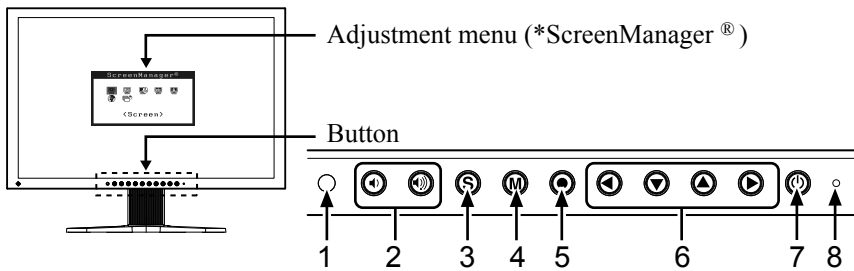

1. Sensor (BrightRegulator)
2. Volume control buttons (Up, Down)
3. Input signal selection button
4. Mode button
5. Enter button
6. Control buttons (Left, Down, Up, Right)
7. Power button
8. Power indicator

Indicator status	Operation status
Blue	The screen is displayed
Orange	Power saving
Off	Power off

\* ScreenManager® is an EIZO's nickname of the Adjustment menu.

### NOTE

- The stand of the unit can be replaced with an arm or another stand. (Refer to “5-1 Attaching an Arm” on page 30.)

### NOTE

- While the screen is displayed, the power indicator that is lighting blue can be turned off (see “To turn off the Power indicator while a screen is displayed [Power Indicator]” on page 21).
- For the power indicator status with “Off Timer” set, refer to “To set monitor power-off time [Off Timer]” on page 18.

# 1-3 Functions and Basic Operation

## To adjust the screen and color

● Main menu (Refer to page 10 for operation)

[At analog signal input]



[At digital signal input]

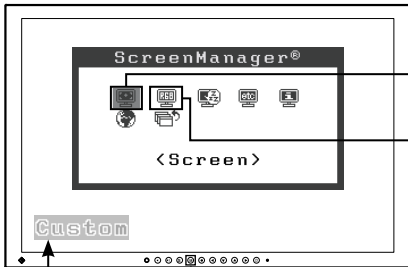

• The Adjustment menu and the FineContrast mode name cannot be displayed at the same time.

(M) FineContrast mode

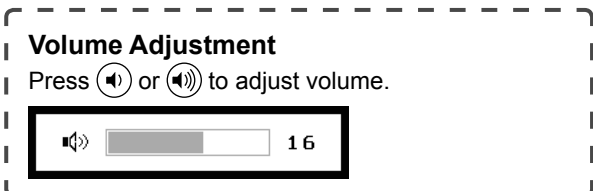
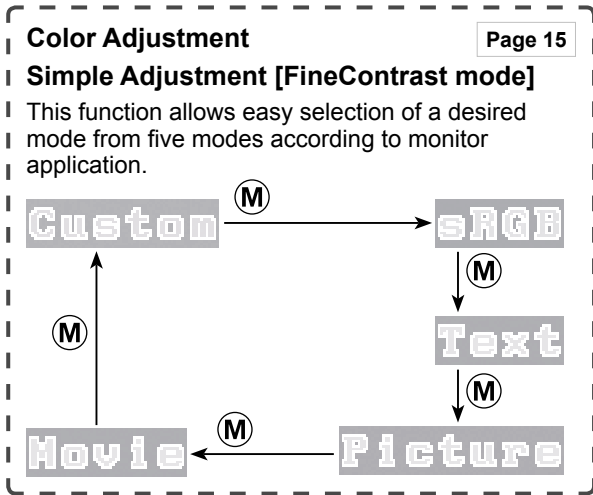

Analog input only

**1 Screen Adjustment (Automatic Adjustment)** Page 12

**Auto Adjustment**

- To adjust flickering and position [Screen] ..... see page 12
- To adjust color gradation automatically [Range] ..... see page 14



**2 Screen Adjustment (Advanced Adjustment)** Page 13

**[At analog signal input] [At digital signal input]**

- To eliminate vertical bars [Clock\*] ... see page 13
- To remove flickering or blurring [Phase\*]..... see page 13
- To correct screen position [Position\*] ..... see page 13
- To modify blurred characters/lines [Smoothing] ..... see page 14
- To set when a noise appears on the screen [Signal Filter\*] ..... see page 27

\* Items marked with \* can be adjusted with analog input.

**Color Adjustment Advanced Adjustment** Page 16

**Color (Custom)**

- “Brightness”, “Contrast”, “Temperature”, “Gamma”, “Saturation”, “Hue” and “Gain” can be set for each mode (Custom/sRGB/Text/Picture/Movie). Settable functions vary with the display mode.

**Resuming the default settings**

- To reset color adjustment [Reset] ... see page 24

## To make useful settings/adjustments

- Adjustment menu (Refer to page 10 for operation)

[At analog signal input]



[At digital signal input]



**Power-save Settings** Page 19

PowerManager™

- Set
- DVI DMPM
- Off

- To set monitor power-saving [VESA DPMS/DVI DMPM]

**Information** Page 23

Information(1/3)

- DVI Digital
- 1920x1200
- fH: 74.0kHz
- fV: 60.0Hz

- To check settings, usage time, etc. [Information]

**Language** Page 23

Language

- English    ○ Deutsch
- Français    ○ Español
- Italiano    ○ Svenska
- 简体中文    ○ 繁體中文
- 日本語

- To set a language to be displayed [Language]

**EIZO Logo Display Setting**

- To display EIZO logo [EIZO Logo Appearing Function] ..... see page 21

**Locking Adjustment**

- To lock operation [Adjustment Lock]... see page 21

**Disabling DDC/CI Communication**

- To disable DDC/CI communication ... see page 22

**Connecting Signal Cables**

- Connecting Two PCs to the Monitor ... see page 25
- Connecting Peripheral USB Devices ... see page 26

Others

<Screen Size>

**Set the off timer**

- To set monitor power-off time [Off Timer] ..... see page 18

**Change the screen size**

- To change screen size [Screen Size] ..... see page 20
- To adjust brightness of non-display area [Border Intensity] ..... see page 20

**BrightRegulator Setting**

- To set automatic brightness adjustment [BrightRegulator] ..... see page 24

**Orientation Setting**

- To set the orientation of the Adjustment menu [Orientation] ..... see page 23

**Power Indicator Setting**

- To turn off the Power indicator while a screen is displayed [Power Indicator] ..... see page 21

**Adjustment menu settings**

- To update menu settings [Menu Size/Menu Position/Menu Off Timer/Translucent] ..... see page 22

**Resume the factory default settings**

















- To reset all settings [Reset] ..... see page 24

**Setting Input Signal Selection**



- To set input signal selection [Input Signal]..... see page 26

## Basic operation of Adjustment menu

### [Displaying Adjustment menu and selecting function]

- (1) Press . The Main menu appears.
- (2) Select a function with  /  /  / , and press . The Sub menu appears.
- (3) Select a function with  /  /  / , and press . The adjustment/setting menu appears.
- (4) Adjust the selected item with  /  /  / , and press . The setting is saved.

### [Exiting Adjustment menu]

- (1) Choose <Return> from the Sub menu and press . The Main menu appears.
- (2) Choose <Exit> from the Main menu and press . The Adjustment menu quits.

#### **NOTE**

- The Adjustment menu can also be exited by pressing  twice quickly.

# Chapter 2 Settings and Adjustments

## 2-1 Utility Disk

An “EIZO LCD Utility Disk” (CD-ROM) is supplied with the monitor. The following table shows the disk contents and the overview of the application software programs.

- **Disk contents and software overview**

The disk includes color profiles, application software programs for adjustment, and User’s Manual. Refer to “Readme.txt” or the “Readme” file on the disk for software startup procedures or file access procedures.

Item	Overview	For Windows	For Macintosh
A “Readme.txt” or “Readme” file		✓	✓
Color Profiles (ICC Profiles)	A specific file including the color characteristic information for the monitor.	✓	✓
Screen Adjustment Program	Available for easy adjustments of the monitor screen following adjustment patterns and procedures on the screen.	✓	✓
ScreenManager Pro for LCD (for Windows)	A utility software program to control monitor adjustments from a PC using its mouse and keyboard. (A PC must be connected to the monitor with the supplied USB cable.) Refer to the description later.	✓	—
WindowMovie Checker Software	WindowMovie is a function of ScreenManager Pro for LCD. For more information, refer to the User’s Manual of ScreenManager Pro for LCD on the disk.		
User’s Manual of this monitor (PDF file)			

- **To use ScreenManager Pro for LCD**

For the installation and use of ScreenManager Pro for LCD, refer to its User’s Manual on the disk.

To adjust the monitor using ScreenManager Pro for LCD, connect a PC to the monitor with the supplied USB cable.

For more information, refer to the “Chapter 3 3-2 Connecting Peripheral USB Devices”.

## 2-2 Screen Adjustment

### Digital Input

When digital signals are input, images are displayed correctly based on the preset data of the monitor. No screen Adjustment is required.

### Analog Input

The monitor screen adjustment is used to suppress flickering of the screen or adjust screen position and screen size correctly according to the PC to be used. To use the monitor comfortably, adjust the screen when the monitor is set up for the first time or when the settings of the PC in use are updated.





The auto-adjustment function works in the following cases:

- When a signal is input into the monitor for the first time
- When a signal is input into the monitor for the first time after the resolution or refresh rate of input signals is changed

#### [Adjustment Procedure]

##### ■ Automatic Adjustment

### 1 To adjust screen automatically [Screen]

- (1) Choose <Screen> from the <Auto Adjustment> menu, and press .
- (2) Choose <Execute> with  or , and press .

Flickering, screen position, and screen size are corrected by the auto-adjustment function.

If satisfactory adjustment cannot be obtained with the auto-adjustment function, perform the adjustment following the procedure below. When the screen is displayed correctly, go to step 4 “Range Adjustment”.

##### ■ Advanced Adjustment

### 2 Run the Screen Adjustment Program.

Load the EIZO LCD Utility Disk on the PC, and start the Screen Adjustment Program compatible with the PC in use.

After the program starts up, perform the adjustment in step 3 following the instructions of the program.

#### Attention

- Wait 30 minutes or more from monitor power on before starting adjustments.

#### NOTE

- Use “Screen Adjustment Program” on the supplied EIZO LCD Utility Disk.

#### Attention

- Auto-adjustment function does not work for the images under the resolution of 800 × 600 (SVGA).

#### Attention

- This function works correctly when an image is fully displayed over the Windows or Macintosh display area. It does not work properly when an image is displayed only on a part of the screen (DOS prompt window, for example) or when a black background (wallpaper, etc.) is in use.
- This function does not work correctly with some graphics boards.
- “Auto in Progress” appears on the screen during auto adjustment.



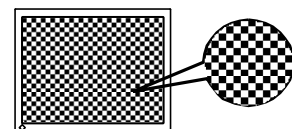

#### NOTE

- For how to start the Screen Adjustment Program, refer to “Readme.txt” or the “Readme” file. When you are using a Windows PC, you can run the program directly from the start menu of the disk.
- If no adjustment program is available for your PC, display a checkerboard pattern on the screen (see below) and go to the following steps.





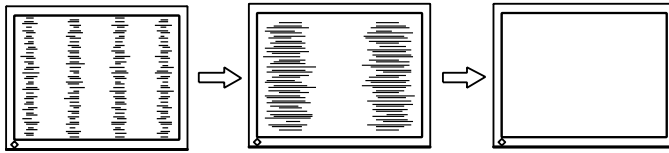

### 3 Perform advanced adjustments for the following using the <Screen> menu of the Adjustment menu.

- **To eliminate vertical bars [Clock]**

- (1) Choose <Clock> from the <Screen> menu, and press .  
The <Clock> menu appears.
- (2) Adjust the clock with  or , and press .





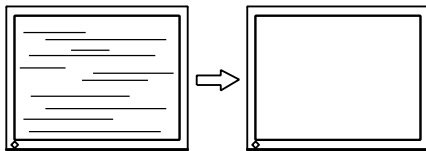

- **To remove flickering or blurring [Phase]**

- (1) Choose <Phase> from the <Screen> menu, and press .  
The <Phase> menu appears.
- (2) Adjust the phase with  or , and press .



- **To correct screen position [Position]**

Since the number of pixels and the pixel positions are fixed on the LCD monitor, only one position is provided to display images correctly. The position adjustment is made to shift an image to the correct position.

- (1) Choose <Position> from the <Screen> menu, and press .  
The <Position> menu appears.
- (2) Adjust the position with  /  /  /  to display the image properly in the display area of the monitor.

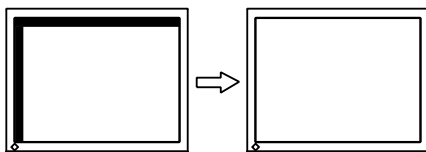

#### NOTE

- Press the control button slowly so as not to miss the adjustment point.
- When blurring, flickering or bars appear on the screen after adjustment, proceed to [Phase] to remove flickering or blurring.

#### Attention

- Flickering or blurring may not be eliminated depending on your PC or graphics board.





#### NOTE

- When vertical bars appear on the screen after adjustment, go back to “To eliminate vertical bars [Clock].” (Clock → Phase → Position)

## 4 Adjust the signal output range.

- **To adjust color gradation automatically [Range]**

Every color gradation (0 to 255) can be displayed by adjusting the signal output level.





- (1) Choose <Range> from the <Auto Adjustment> menu, and press .
- (2) Choose “Execute” with  or , and press .  
The output range is adjusted automatically.

When using the “Screen Adjustment Program”, quit the program.

## 5 Change the smoothing setting.

- **To modify blurred characters/lines [Smoothing]**

When a low-resolution image is displayed in the “Full” or “Enlarged” mode, the characters or lines of the displayed image may be blurred.

- (1) Choose <Screen> from the Adjustment menu, and press .
- (2) Choose <Smoothing> from the <Screen> menu, and press .  
The <Smoothing> menu appears.
- (3) Adjust the characters/lines with  or , and press .  
The smoothing adjustment is completed.

### Attention

- Smoothing setting may not be required depending on the display resolution. (You cannot choose the smoothing icon.)



## 2-3 Color Adjustment

### Simple adjustment [FineContrast mode]

This function allows you to select the best display mode for monitor brightness, etc.

- **FineContrast Mode**

An appropriate display mode is selectable out of five modes.

Mode	Purpose
Custom	Available for making desired setting.
sRGB	Suitable for color matching with sRGB compatible peripherals.
Text	Suitable for displaying texts for word processing or spreadsheets.
Picture	Suitable for displaying images such as photos or picture images.
Movie	Suitable for playing back animated images.

**FineContrast mode name**

Example) Custom

**Custom** — Displays current mode.

- **To select FineContrast mode**

- (1) Press **(M)**.  
The FineContrast mode name appears at the lower left of the screen.
- (2) One of five modes is displayed in turn each time **(M)** is pressed.

→ Custom → sRGB → Text → Picture → Movie →

- (3) Choose desired mode and press **(O)**.  
The setting completes.

**NOTE**

- The Adjustment menu and the FineContrast mode name cannot be displayed at the same time.

## Advanced Adjustments [Adjustment menu]

Independent setting and saving of color adjustment are available for each FineContrast mode.

### • To select an appropriate mode for images

✓: Adjustment available    -: Invalid for adjustment

Icon	Function	FineContrast mode				
		Custom	sRGB	Text	Picture	Movie
	Brightness	✓	✓	✓	✓	✓
	Contrast	✓	-	✓	✓	✓
	Temperature	✓	-	✓	✓	✓
	Gamma	✓	-	✓	-	-
	Saturation	✓	-	✓	✓	✓
	Hue	✓	-	✓	✓	✓
	Gain	✓	-	-	-	-
	Reset	✓	✓	✓	✓	✓



Menu	Description	Adjustment range
Brightness 	To adjust the full screen brightness as desired	0 to 100%
	<b>NOTE</b> <ul style="list-style-type: none"> <li>You can also adjust the brightness by pressing ◀ or ▶ button while the adjustment menu is not displayed.</li> <li>Press ● after adjustment.</li> <li>The values shown in the “%” are available only as reference.</li> </ul>	
Contrast 	To adjust the contrast of the image	0 to 100% In the contrast of 50%, all color gradation is displayed.
	<b>NOTE</b> <ul style="list-style-type: none"> <li>The values shown in the “%” are available only as reference.</li> </ul>	
Temperature 	To select a color temperature	4000K to 10000K in units of 500K (including 9300K).
	<b>NOTE</b> <ul style="list-style-type: none"> <li>Setting the value to “Off” presents the natural color temperature of the panel.</li> <li>The values shown in the Kelvin (K) are available only as reference.</li> </ul>	
Gamma 	To set a gamma value	1.8, 2.0, 2.2
Saturation 	To adjust color saturation	-128 to 127 Setting the minimum (-128) turns the image to a monochrome screen.
	<b>Attention</b> <ul style="list-style-type: none"> <li>This function does not enable to display every color gradation.</li> </ul>	
Hue 	To produce a desired skin color, etc.	-32 to 32
	<b>Attention</b> <ul style="list-style-type: none"> <li>This function does not enable to display every color gradation.</li> </ul>	

### Attention











- Perform [Range Adjustment] before starting color adjustment for analog input signals.  
Refer to “To adjust color gradation automatically” on page 14.
- Wait 30 minutes or more from monitor power on before starting the color adjustment.
- Choose “Reset” in the <Color> menu to revert to the default settings (factory settings) of hue of the color mode selected.
- The same image may be seen in different colors on multiple monitors due to their monitor-specific characteristics. Make fine color adjustment visually when matching colors on multiple monitors.

### NOTE

- The Adjustment menu and the FineContrast mode name cannot be displayed at the same time.
- Adjustable functions vary depending on the type of FineContrast mode.

Menu	Description	Adjustment range
Gain 	To adjust red, green, and blue to a desired color tone respectively	0 to 100% Adjust the respective brightness of red/green/blue to make a desired color tone. Display an image with white or gray background for adjustment.
	<b>NOTE</b> <ul style="list-style-type: none"> <li>• The values shown in the “%” are available only as reference.</li> <li>• When using the &lt;Gain&gt; setting, the &lt;Temperature&gt; setting is set to “Off.”</li> </ul>	
Reset 	To reset the color settings of the selected FineContrast mode to the default settings	

• **To set/adjust color**

- (1) Choose <Color> from the Adjustment menu, and press .
- (2) Select a desired function with  /  /  /  from the <Color> menu, and press .  
The selected function menu appears.
- (3) Adjust the selected item with  /  /  / , and press .  
The adjustment is completed.

## 2-4 Off Timer/Power Saving Settings

### • To set monitor power-off time [Off Timer]







This function allows the monitor to automatically turn off after a specified time has passed. This function serves to reduce afterimages caused when the monitor screen is left on for a long time period without use. Use this function when an image is displayed throughout the day.

#### [Off Timer System]

Timer	Monitor	Power Indicator
ON time (1H - 23H)	Operating	Blue
Last 15 min. in "ON time"	Advance Notice*	Flashing blue
"ON time" expired	Power Off	Off

\* When  is pressed during the advance notice period, the monitor continues to operate for additional 90 minutes. Extension of operation time can be set without limitation.

#### [Procedure]

- (1) Choose <Others> from the Adjustment menu, and press .
- (2) Choose <Off Timer> from the <Others> menu, and press .  
The <Off Timer> menu appears.
- (3) Select "Enable" with  or .
- (4) Set a monitor ON time (1 to 23 hours) with  or , and press .  
The Off Timer setting is completed.

#### [Resumption Procedure]

- Press .

#### Attention

- The Off Timer functions even in the power saving mode, but the advance notice is disabled. The monitor power is turned off without advance notice.

- **To set monitor power-saving [VESA DPMS/DVI DMPM]**

- **Analog input**

This monitor complies with the VESA DPMS standard.

**[Power Saving System]**

PC		Monitor	Power Indicator
Operating		Operating	Blue
Power saving	STAND-BY SUSPENDED OFF	Power saving	Orange

**[Procedure]**

- (1) Choose <PowerManager> from the Adjustment menu, and press ●. The <Set> menu appears.
- (2) Select “VESA DPMS” with ▲ or ▼, and press ●. The power saving setting is completed.

**[Resumption Procedure]**

- Operate the mouse or keyboard to resume the normal screen.

- **Digital input**

This monitor complies with the DVI DMPM standard.

**[Power Saving System]**

The monitor enters the power saving mode in five seconds in connection with the PC setting.

PC	Monitor	Power Indicator
Operating	Operating	Blue
Power saving	Power saving	Orange

**[Procedure]**

- (1) Choose <PowerManager> from the Adjustment menu, and press ●. The <Set> menu appears.
- (2) Select “DVI DMPM” with ▲ or ▼, and press ●. The power saving setting is completed.

**[Resumption Procedure]**

- Operate the mouse or keyboard to resume the normal screen.

**Attention**

- Unplugging the power cord completely shuts off power supply to the monitor.
- USB compliant devices connected to the monitor work even if the monitor is in the power saving mode. Therefore, power consumption of the monitor varies with connected devices even in the power saving mode.
- Power consumption changes even when a sound input signal is detected.

## 2-5 Screen Size Selection

### • To change screen size [Screen Size]

The image with the resolution other than the recommended resolution is displayed in full screen automatically. You can change the screen size by using <Screen Size> from <Others> menu.

Menu	Function
Full Screen (default setting)	Displays an image in full screen. Images are distorted in some cases because the vertical rate is not equal to the horizontal rate.
Enlarged	Displays an image in full screen. In some cases, a blank horizontal or vertical border appears to equalize the vertical rate and the horizontal rate.
Normal	Displays images with the specified resolution.

Example: Image size 1280 × 1024

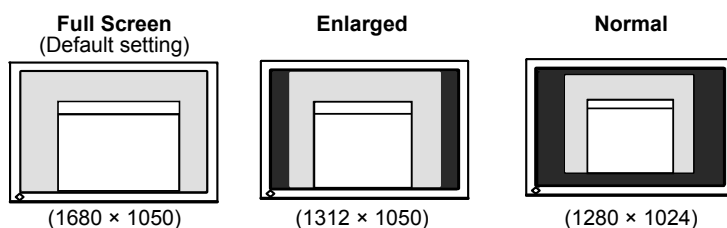

#### [Procedure]

- (1) Choose <Others> from the Adjustment menu, and press .
- (2) Choose <Screen Size> from the <Others> menu, and press .  
The screen size setting window appears.
- (3) Select “Full Screen,” “Enlarged,” or “Normal” with  or , and press .  
The screen size setting is completed.

### • To adjust brightness of non-display area [Border Intensity]

A border (black area with no image) around the image appears in the “Normal” or “Enlarged” mode.

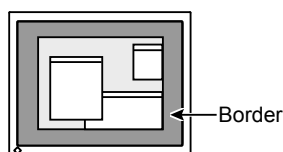





- (1) Choose <Others> from the Adjustment menu, and press .
- (2) Choose <Border Intensity> from the <Others> menu, and press .  
The <Border Intensity> menu appears.
- (3) Adjust border intensity with  or , and press .  
The border intensity adjustment is completed.

## 2-6 Power Indicator/EIZO Logo Display Setting

### • To turn off the Power indicator while a screen is displayed [Power Indicator]



This function enables to turn off the Power indicator (blue) while a screen is displayed.

- (1) Choose <Others> from the Adjustment menu, and press .
- (2) Choose <Power Indicator> from the <Others> menu, and press .  
The <Power Indicator> menu appears.
- (3) Select "Disable" with  or , and press .  
The Power Indicator setting is completed.



### • To display EIZO logo [EIZO Logo Appearing Function]

When this unit is turned on, the EIZO logo appears at the center of the screen. Selection to display or not to display the logo is available with this function.

#### [Procedure]

- (1) Press  to turn off the unit.
- (2) Press  again while pressing .  
The EIZO logo does not appear on the screen.







#### [Resetting]



- (1) Press  to turn off the unit.
- (2) Press  again while pressing .  
The logo appears again.

## 2-7 Locking Buttons



### • To lock operation [Adjustment Lock]

This function locks the buttons to retain the status adjusted or set once.

Buttons that can be locked	<ul style="list-style-type: none"> <li>•  (Enter button) Adjustments/settings using Adjustment menu</li> </ul>
Buttons that cannot be locked	<ul style="list-style-type: none"> <li>•  (Power button)</li> <li>•  (Mode button) FineContrast mode name selection</li> <li>•  (Input signal selection)</li> <li>•  (Volume control buttons)</li> <li>•  /  (Control buttons) Brightness adjustment</li> </ul>

- (1) Press  to turn off the unit.
- (2) Press  again while pressing .  
The screen is displayed with the adjustment lock.

#### [Unlocking]

- (1) Press  to turn off the unit.
- (2) Press  again while pressing .  
The screen is displayed with the adjustment lock released.

#### NOTE

- The Power indicator lights up at power on with the default setting.



#### NOTE

- The logo appears with the default setting.



## 2-8 Disabling DDC/CI Communication

### • To disable DDC/CI communication



#### [Procedure]

- (1) Press  to turn off the unit.
- (2) Press  again while pressing .  
DDC/CI communication setting is disabled.

#### [Resetting]

- (1) Press  to turn off the unit.
- (2) Press  again while pressing .  
DDC/CI communication setting is enabled.

#### [Checking the setting status]







- (1) Select <Information> menu in the Adjustment menu and press .  
The <Information> menu appears.
- (2) Pressing  continuously, the DDC/CI communication setting status is shown on the 2nd page of the information page.

## 2-9 Setting Adjustment Menu Display

### • To update menu settings [Menu Size/Menu Position/Menu Off Timer/Translucent]









#### Menu Size

Change the Adjustment menu size using the following procedure.

- (1) Choose <Others> from the Adjustment menu, and press .
- (2) Choose <Menu Settings> from the <Others> menu, and press .
- (3) Choose <Menu Size> from the <Menu Settings> menu, and press .
- The <Menu Size> menu appears.
- (4) Select “Enlarged” using  or , and press .
- The menu size setting is completed.









#### Menu Position

Adjust the menu position using the following procedure.

- (1) Choose <Others> from the Adjustment menu, and press .
- (2) Choose <Menu Settings> from the <Others> menu, and press .
- (3) Choose <Menu Position> from the <Menu Settings> menu, and press .
- The <Menu Position> menu appears.
- (4) Select a menu position with  /  /  / , and press .
- The menu position setting is completed.

#### Menu Off Timer

Set the menu display time using the following procedure.

- (1) Choose <Others> from the Adjustment menu, and press .
- (2) Choose <Menu Settings> from the <Others> menu, and press .
- (3) Choose <Menu Off Timer> from the <Menu Settings> menu, and press .
- The <Menu Off Timer> menu appears.
- (4) Select “Enable” with  or .
- (5) Choose an Off Time (15/30/45/60 seconds) with  or , and press .
- The menu off timer setting is completed.







#### NOTE

- The display time of the FineContrast mode remains unchanged.



## Translucent





Set the transparency for menu display using the following procedure.

- (1) Choose <Others> from the Adjustment menu, and press .
- (2) Choose <Menu Settings> from the <Others> menu, and press .
- (3) Choose <Translucent> from the <Menu Settings> menu, and press .  
The <Translucent> menu appears.
- (4) Adjust the transparency for menu display with  or , and press .  
The transparency setting is completed.

## 2-10 Setting Orientation

### • To set the orientation of the Adjustment menu [Orientation]



The orientation of the Adjustment menu can be turned 90 degrees.

- (1) Choose <Others> from the Adjustment menu, and press .
- (2) Choose <Orientation> from the Others menu, and press .  
The <Orientation> menu appears.
- (3) Select “Landscape” or “Portrait” with  or , and press .  
The orientation setting is completed.

## 2-11 Viewing Information/Setting Language

### • To check settings, usage time, etc. [Information]

This function allows you to check settings, model name, serial number, and usage time of the monitor.







- (1) Choose <Information> from the Adjustment menu, and press .  
The <Information> menu appears.
- (2) Then, press  to check settings, etc.

### • To set a language to be displayed [Language]

This function allows to select the Adjustment menu language.

#### Selectable languages

English/German/French/Spanish/Italian/Swedish/Simplified Chinese/  
Traditional Chinese/Japanese

- (1) Choose <Language> menu from the Adjustment menu, and press .  
The <Language> menu appears.
- (2) Choose a language with  /  /  / , and press .  
The language setting is completed.



#### NOTE

- The usage time is not always “0” when you purchase the monitor due to factory inspection.



## 2-12 Setting BrightRegulator

### • To set automatic brightness adjustment [BrightRegulator]

The sensor on the front side of the monitor detects the environmental brightness to adjust the screen brightness automatically and comfortably.

- (1) Choose <Others> from the Adjustment menu, and press .
- (2) Choose <BrightRegulator> from the <Others> menu, and press .

The BrightRegulator setting window appears.



- (3) Select “Enable” or “Disable” with  or , and press .

The BrightRegulator setting is completed.



## 2-13 Resumption of Default Setting

### • To reset color adjustment [Reset]

The hue in the color mode currently set will revert to the default settings (factory settings).

- (1) Choose <Color> from the Adjustment menu, and press .
- (2) Choose <Reset> from the <Color> menu and press .



The <Reset> menu appears.

- (3) Select <Reset> with  or , and press .



The reset operation is completed.

### • To reset all settings [Reset]

Reset all adjustments/settings to the factory default settings.

- (1) Choose <Others> from the Adjustment menu, and press .
- (2) Choose <Reset> from the <Others> menu, and press .

The <Reset> menu appears.

- (3) Select <Reset> with  or , and press .

The reset operation is completed.

#### NOTE

- Be careful not to block the sensor on the lower side of the monitor when using the BrightRegulator function.

#### NOTE

- For main default settings, refer to “Main default settings (factory settings)” on page 34.

# Chapter 3 Connecting Cables

## 3-1 Connecting Two PCs to the Monitor

Two PCs can be connected to the monitor through the DVI-I and the D-Sub mini 15 pin connector on the back of the monitor.

### Connection examples

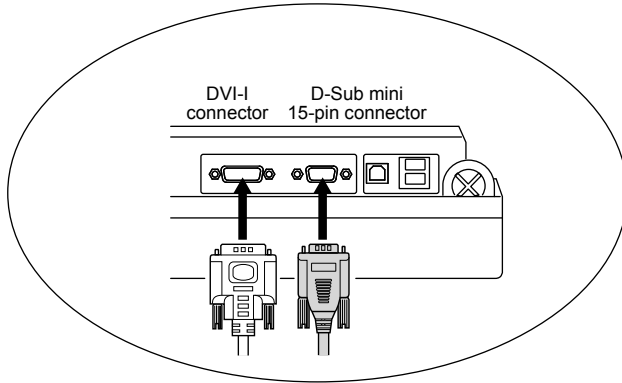

#### Attention

- When using an optional signal cable (FD-C16), be sure to connect the D-sub mini 15-pin connector to the PC, and the DVI-I connector to the monitor. Wrong connection may result in no picture display.

		PC 1		PC 2			
Example 1	Digital	DVI	Signal cable (supplied with FD-C39)	Signal cable (supplied MD-C87)	D-sub mini 15-pin	Analog	
Example 2	Analog	D-sub mini 15-pin	Signal cable (FD-C16 option)	Signal cable (supplied MD-C87)	D-sub mini 15-pin	Analog	

### Selecting input signal

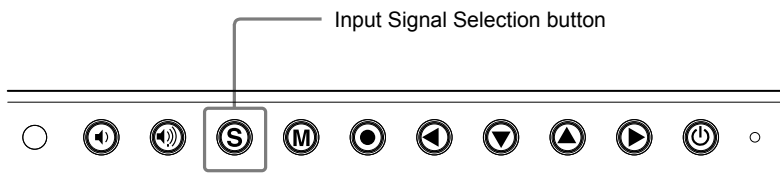

Switch the input signal with **(S)**. Input signal switches each time **(S)** is pressed. When the signal is switched, the active signal type (Analog or Digital) appears at the top right corner of the screen.

- **To set input signal selection [Input Signal]**

The monitor recognizes the connector through which PC signals are input. When either PC is turned off or enters the power-saving mode, the monitor automatically displays signals of another PC.

Priority setting	Function
Auto	When either PC is turned off or enters the power-saving mode, the monitor automatically displays signals of another PC.
Manual	The monitor does not detect the PC's signals automatically. Select an active input signal with (S).

**[Input signal setting]**

- (1) Choose <Others> from the Adjustment menu, and press (●).
- (2) Choose <Input Signal> from the <Others> menu, and press (●).  
The <Input Signal> menu appears.
- (3) Select "Auto" or "Manual" with (▲) or (▼), and press (●).  
The Input Priority setting is completed.

## 3-2 Connecting Peripheral USB Devices

This monitor has a hub compatible with USB. Connected to a PC compatible with USB or another USB hub, this monitor functions as a USB hub allowing connection to peripheral USB devices.

- **Required System Environment**
  - (1) A PC equipped with a USB port or another USB hub connected to a USB compatible PC
  - (2) Windows 2000/XP/Vista or Mac OS 9.2.2 and Mac OS X 10.2 or later
  - (3) EIZO USB cable (MD-C93)
- **Connection Procedure (Setup of USB Function)**
  - (1) Connect the monitor first to a PC using the signal cable, and run the PC.
  - (2) Connect the supplied USB cable between the downstream USB port of a USB compatible PC (or another USB hub) and the monitor's upstream USB port.
  - (3) When the USB function setup is completed, the monitor functions as a USB hub allowing connection to various peripheral USB devices through its downstream USB ports.

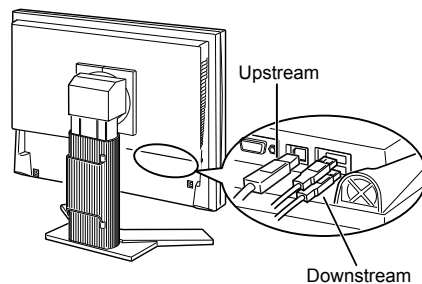

The USB function is set up automatically upon connection of the USB cable.

**NOTE**

- When "Auto" is selected for <Input Signal>, the monitor's power-saving function works only when the two PCs are in the power-saving mode.





**Attention**



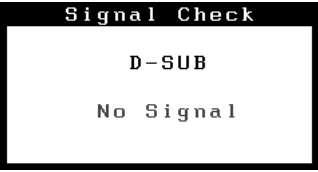

- This monitor may not work depending on PC, OS or peripheral devices to be used.  
For USB compatibility of peripheral devices, contact their manufactures.
- If the monitor is in the power saving mode, or if the monitor is connected to the power outlet with the monitor turned off, all the devices connected to the USB ports (upstream and downstream) work. Therefore, power consumption of the monitor varies with connected devices even in the power saving mode.

# Chapter 4 Troubleshooting

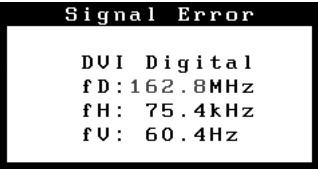
If a problem still remains after applying the suggested remedies, contact your local dealer.

- No-picture problems → See No.1 - No.2.
- Imaging problems (digital input) → See No.3 - No.8.
- Imaging problems (analog input) → See No.3 - No.12.
- Other problems → See No.13 - No.17.
- USB problems → See No.18.

Problems	Possible cause and remedy
<b>1. No picture</b> <ul style="list-style-type: none"> <li>• Power indicator does not light.</li> </ul>	<ul style="list-style-type: none"> <li>• Check whether the power cord is connected correctly. If the problem persists, turn off the monitor, and then turn it on again a few minutes later.</li> <li>• Press .</li> </ul>
<ul style="list-style-type: none"> <li>• Power indicator is lighting blue.</li> <li>• Power indicator is lighting orange.</li> </ul>	<ul style="list-style-type: none"> <li>• Check &lt;Gain&gt; setting. (see page 17)</li> <li>• Switch the input signal with .</li> <li>• Operate the mouse or keyboard.</li> <li>• Check whether the PC is turned on.</li> </ul>
<b>2. The message below appears.</b> <ul style="list-style-type: none"> <li>• This message appears when no signal is input.</li> </ul> 	<p>This message appears when the signal is not input correctly even when the monitor functions properly.</p> <ul style="list-style-type: none"> <li>• The message shown left may appear, because some PCs do not output the signal soon after power-on.</li> <li>• Check whether the PC is turned on.</li> <li>• Check whether the signal cable is connected properly.</li> <li>• Switch the input signal with .</li> </ul>
<ul style="list-style-type: none"> <li>• The message below shows that the input signal is out of the specified frequency range. (Such signal frequency is displayed in red.) Example:</li> </ul> 	<ul style="list-style-type: none"> <li>• Reboot the PC.</li> <li>• Select an appropriate display mode using the graphics board's utility. Refer to the manual of the graphics board for details.</li> </ul>
<b>3. The screen is too bright or too dark.</b>	<ul style="list-style-type: none"> <li>• Adjust &lt;Brightness&gt;. (The LCD monitor backlight has a fixed life span. When the screen becomes dark or begins to flicker, contact your local dealer.)</li> </ul>
<b>4. Characters are blurred.</b>	<ul style="list-style-type: none"> <li>• Adjust using &lt;Smoothing&gt;. (see page 14)</li> </ul>
<b>5. Afterimages appear.</b>	<ul style="list-style-type: none"> <li>• Use a screen saver or off timer function for a long-time image display.</li> <li>• Afterimages are particular to LCD monitors. Avoid displaying the same image for a long time.</li> </ul>
<b>6. Green/red/blue/white dots or defective dots remain on the screen.</b>	<ul style="list-style-type: none"> <li>• This is due to LCD panel characteristics and is not a failure.</li> </ul>
<b>7. Interference patterns or pressure marks remain on the screen.</b>	<ul style="list-style-type: none"> <li>• Leave the monitor with a white or black screen. The symptom may disappear.</li> </ul>
<b>8. Noise appears on the screen.</b>	<ul style="list-style-type: none"> <li>• When entering the signals of analog input, select 1 to 4 in &lt;Signal Filter&gt; from the &lt;Screen&gt; menu to change the mode.</li> <li>• When entering the signals of HDCP system, the normal images may not be displayed immediately.</li> </ul>

Problems	Possible cause and remedy
<p><b>9. Display position is incorrect.</b></p> 	<ul style="list-style-type: none"> <li>• Adjust image position so that it is displayed properly within the display area using the “Hor.Position” and “Ver. Position” adjustment.</li> <li>• If the problem persists, use the graphics board’s utility if available to change the display position.</li> </ul>
<p><b>10. Vertical bars appear on the screen or a part of the image is flickering.</b></p> 	<ul style="list-style-type: none"> <li>• Adjust using &lt;Clock&gt;. (see page 13)</li> </ul>
<p><b>11. Whole screen is flickering or blurring.</b></p> 	<ul style="list-style-type: none"> <li>• Adjust using &lt;Phase&gt;. (see page 13)</li> </ul>
<p><b>12. Upper part of the screen is distorted as shown below.</b></p> 	<ul style="list-style-type: none"> <li>• This is caused when both composite sync (X-OR) signal and separate vertical sync signal are input simultaneously. Select either composite signal or separate signal.</li> </ul>
<p><b>13. The &lt;Smoothing&gt; icon on the Adjustment menu &lt;Screen&gt; cannot be selected.</b></p>	<ul style="list-style-type: none"> <li>• Smoothing setting may not be required depending on the display resolution. (You cannot choose the smoothing icon.)</li> <li>• &lt;Smoothing&gt; is disabled when the screen is displayed in the following resolutions. <ul style="list-style-type: none"> <li>• 1680 × 1050</li> <li>• Select [Normal] during &lt;Screen Size&gt;.</li> </ul> </li> </ul>
<p><b>14. The Main menu of Adjustment menu does not start.</b></p>	<ul style="list-style-type: none"> <li>• Check for Adjustment Lock function. (see page 21)</li> </ul>
<p><b>15. The FineContrast mode is not displayed.</b></p>	<ul style="list-style-type: none"> <li>• Check whether the Main menu of Adjustment menu is displayed. (Refer to “Advanced Adjustments [Adjustment menu]” on page 16.)</li> </ul>
<p><b>16. The auto-adjustment function does not work correctly.</b></p>	<ul style="list-style-type: none"> <li>• This function does not work when digital signal is input.</li> <li>• This function does not work correctly with some graphics boards.</li> </ul>
<p><b>17. No audio output.</b></p>	<ul style="list-style-type: none"> <li>• Check whether the mini jack cable is correctly connected.</li> <li>• Check whether volume is set to 0.</li> <li>• Check the setting of the PC and the audio playback software.</li> </ul>

Problems	Possible cause and remedy
<p><b>18. The monitor connected with the USB cable is detected. / USB devices connected to the monitor does not work.</b></p>	<ul style="list-style-type: none"> <li>• Check whether the USB cable is connected correctly.</li> <li>• Change the USB port to another one. If the PC or peripheral devices works correctly by changing the USB port, contact your local dealer. (Refer to the manual of the PC for details.)</li> <li>• Please perform the followings to check the status. <ul style="list-style-type: none"> <li>• Reboot the PC.</li> <li>• Connect the PC and peripheral devices directly.</li> </ul> </li> <li>• If the PC or peripheral devices works correctly without connecting each other via the monitor (working as a USB hub), please contact your local dealer.</li> <li>• Check whether the PC and OS are USB compliant. (For USB compliance of the respective devices, consult their manufacturers.)</li> <li>• Check the PC's BIOS setting for USB when using Windows. (Refer to the manual of the PC for details.)</li> </ul>

# Chapter 5 Reference

## 5-1 Attaching an Arm

The stand can be removed and replaced with an arm (or another stand) to be attached to the monitor. Use an arm or stand of EIZO option.

### [Attaching]

**1** Lay the LCD monitor on a soft cloth spread over on a stable surface with the panel surface facing down.

**2** Remove the stand. (Prepare a screwdriver.)

Unscrew the four screws securing the unit and the stand with the screwdriver.

**3** Attach the monitor to the arm or stand.

Secure the monitor to the arm or stand using the screws specified in the user's manual of the arm or stand.

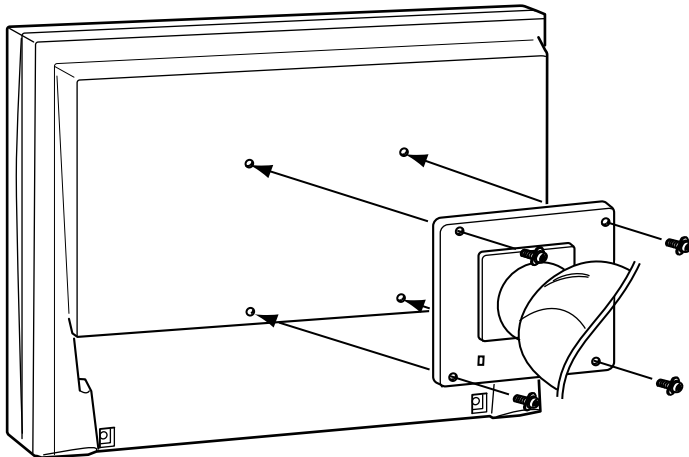

### Attention

- When attaching an arm or stand, follow the instructions of their user's manual.
- When using another manufacturer's arm or stand, confirm the following in advance and select one conforming to the VESA standard. Use the M4 × 12 mm screws supplied with this monitor.
  - Clearance between the screw holes: 100 mm × 100 mm
  - Thickness of plate: 2.6 mm
  - Strong enough to support weight of the monitor unit (except the stand) and attachments such as cables.
- When using an arm or stand, attach it to meet the following tilt angles of the monitor.
  - Height adjustable stand:  
Up 40 degrees, down 0 degrees (vertical display, 90 degrees clockwise)
  - EZ-UP stand:  
Up 25 degrees, down 0 degrees (vertical display, 90 degrees clockwise)
- Connect the cables after attaching an arm.
- If you need to remove the EZ-UP stand, turn the panel on the monitor to the left and right a little to appear the four screws positioned under the stand. Then unscrew the four screws.



---

## 5-2 Cleaning

Clean the monitor periodically to keep the monitor clean and extend its life.

### Cabinet

Clean the cabinet with a soft cloth dampened with little mild detergent.

### LCD Panel

- Clean the LCD panel with a soft cloth such as cotton cloth or lens cleaning paper.
- Remove persistent stains gently with a cloth dampened with little water, and then clean the LCD panel again with a dry cloth for better finishing.

#### Attention

- Never use any solvents or chemicals, such as thinner, benzene, wax, alcohol, and abrasive cleaner, which may damage the cabinet or LCD panel.

#### NOTE

- Optional ScreenCleaner is recommended for cleaning the LCD panel surface.

## 5-3 Specifications

### S2001W

LCD Panel		20.1-inch (510 mm) TFT color LCD with anti-glare hard coating Viewing angle*: Horizontal 170°, Vertical 170° (CR:10 or more)
Dot Pitch		0.258mm
Horizontal Scan Frequency		Analog: 24-82kHz Digital: 31-65kHz
Vertical Scan Frequency		Analog: 49-86Hz (Non-interlace) (1280 × 1024: 49-76Hz) (1680 × 1050: 49-61Hz) Digital: 59-61Hz (Non-interlace) (VGA TEXT: 69-71Hz)
Resolution		1680 dots × 1050 lines
Max. Dot Clock		Analog: 150MHz Digital: 120MHz
Max. Display Color		Approx. 16.77 million colors: Applicable to 8 bit (1048.77 million colors)
Display Area (H × V)		433.4mm × 270.9mm
Power Supply		100-120 VAC ±10%, 50/60Hz 1.0A 200-240 VAC ±10%, 50/60Hz 0.6A
Power Consumption	Screen Display On	60W or less (with USB load, when stereo mini jack is connected) 50W or less (without USB load, when stereo mini jack is not connected)
	Power saving mode	1W or less (for single signal input, without USB load, when stereo mini jack is not connected)
	Power button Off	0.7W or less (without USB load, when stereo mini jack is not connected)
Input Signal Connector		DVI-I connector (Applicable to HDCP), D-Sub mini 15-pin
Analog Input Signal (Sync)		Separate, TTL, positive/ negative
		Composite, TTL, positive/ negative
Analog Input Signal (Video)		Analog, Positive (0.7Vp-p/75Ω)
Digital Signal Transmission System		TMDS (Single Link)
Video Signal Memory		Analog signal: 45 (preset: 24)
		Digital signal: 10 (preset: 0)
Audio Output		Speaker output: 0.5W + 0.5W (8Ω, THD: 10% or less) Headphone output: 2mW + 2mW
Line input		Input impedance : 47 kΩ (typ.) Input level :1.0 Vrms (Max.)
Plug & Play		VESA DDC 2B / EDID structure 1.3
Dimensions (Width) × (Height) × (Depth) mm (inch)	Main unit (including Height adjustable stand)	469mm(18.5) × 427 - 509mm(16.8 - 20.0) × 208.5mm(8.2)
	Main unit (including EZ-UP stand)	469mm(18.5) × 339.5 - 504.5mm(13.4 - 19.9) × 279.9 - 291.9mm(11.0 - 11.5)
	Main unit (without stand)	469mm(18.5) × 309mm(12.2) × 69.5mm(2.7)
Mass	Main unit (including Height adjustable stand)	8.7 kg (19.2 lbs.)
	Main unit (including EZ-UP stand)	10.5 kg (23.1 lbs.)
	Main unit (without stand)	5.7 kg (12.6 lbs.)

\* LCD Module characteristics only

Movable range	Tilt	Height adjustable stand : 40° Up, 0° Down EZ-UP stand : 25° Up, 0° Down
	Swivel	Height adjustable stand : 35° Right, 35° Left EZ-UP stand : 172° Right, 172° Left
	Adjustable height	Height adjustable stand : 82 mm EZ-UP stand : 165 mm
	Rotation	Height adjustable stand : 90° EZ-UP stand : 90°
Environmental Conditions	Temperature	Operating temperature: 0 °C - 35 °C Storage temperature: -20 °C - 60 °C
	Humidity	Relative humidity: 30% - 80% (no condensation)
USB	Standard	USB Specification Revision 2.0
	Port	Upstream port × 1, Downstream port × 2
	Supply current	Downstream: Max. 500mA/1 port

### S2201W

LCD Panel	22.0-inch (560 mm) TFT color LCD with anti-glare hard coating Viewing angle*: Horizontal 170°, Vertical 160° (CR:10 or more)	
Dot Pitch	0.282mm	
Horizontal Scan Frequency	Analog: 24-82kHz Digital: 31-65kHz	
Vertical Scan Frequency	Analog: 49-86Hz (Non-interlace) (1280 × 1024: 49-76Hz) (1680 × 1050: 49-61Hz) Digital: 59-61Hz (Non-interlace) (VGA TEXT: 69-71Hz)	
Resolution	1680 dots × 1050 lines	
Max. Dot Clock	Analog: 150MHz Digital: 120MHz	
Max. Display Color	Approx. 16.77 million colors: Applicable to 8 bit (1048.77 million colors)	
Display Area (H × V)	473.8mm × 296.1mm	
Power Supply	100-120 VAC ±10%, 50/60Hz 1.0A 200-240 VAC ±10%, 50/60Hz 0.6A	
Power Consumption	Screen Display On	60W or less (with USB load, when stereo mini jack is connected) 50W or less (without USB load, when stereo mini jack is not connected)
	Power saving mode	1W or less (for single signal input, without USB load, when stereo mini jack is not connected)
	Power button Off	0.7W or less (without USB load, when stereo mini jack is not connected)
Input Signal Connector	DVI-I connector (Applicable to HDCP), D-Sub mini 15-pin	
Analog Input Signal (Sync)	Separate, TTL, positive/ negative	
	Composite, TTL, positive/ negative	
Analog Input Signal (Video)	Analog, Positive (0.7Vp-p/75Ω)	
Digital Signal Transmission System	TMDS (Single Link)	
Video Signal Memory	Analog signal: 45 (preset: 24)	
	Digital signal: 10 (preset: 0)	
Audio Output	Speaker output: 0.5W + 0.5W (8Ω, THD: 10% or less) Headphone output: 2mW + 2mW	
Line input	Input impedance : 47 kΩ (typ.) Input level : 1.0 Vrms (Max.)	

\* LCD Module characteristics only

Plug & Play		VESA DDC 2B / EDID structure 1.3
Dimensions (Width) × (Height) × (Depth) mm (inch)	Main unit (including Height adjustable stand)	507mm(20.0) × 439 - 521mm(17.3 - 20.5) × 230mm(9.1)
	Main unit (including EZ-UP stand)	507mm(20.0) × 351.5 - 516.5mm(13.8 - 20.3) × 279.9 - 296.4mm(11.0 - 11.7)
	Main unit (without stand)	507mm(20.0) × 333mm(13.1) × 74mm(2.9)
Mass	Main unit (including Height adjustable stand)	10.2 kg (22.5 lbs.)
	Main unit (including EZ-UP stand)	11.5 kg (25.4 lbs.)
	Main unit (without stand)	6.7 kg (14.8 lbs.)
Movable range	Tilt	Height adjustable stand : 40° Up, 0° Down EZ-UP stand : 25° Up, 0° Down
	Swivel	Height adjustable stand : 35° Right, 35° Left EZ-UP stand : 172° Right, 172° Left
	Adjustable height	Height adjustable stand : 82 mm EZ-UP stand : 165 mm
	Rotation	Height adjustable stand : 90° EZ-UP stand : 90°
Environmental Conditions	Temperature	Operating temperature: 0 °C - 35 °C Storage temperature: -20 °C - 60 °C
	Humidity	Relative humidity: 30% - 80% (no condensation)
USB	Standard	USB Specification Revision 2.0
	Port	Upstream port × 1, Downstream port × 2
	Supply current	Downstream: Max. 500mA/1 port

### Main default settings (factory settings)

BrightRegulator		Disable
Smoothing		3
FineContrast Mode		Custom
PowerManager		VESA DPMS (Analog Input) DVI DMPM (Digital Input)
Screen Size		Full Screen
Off Timer		Disable
Menu Settings	Menu Size	Normal
	Menu Off Timer	45 sec
Language		English

**Outside Dimensions**  
**S2001W (Height adjustable stand)**

unit : mm (inch)

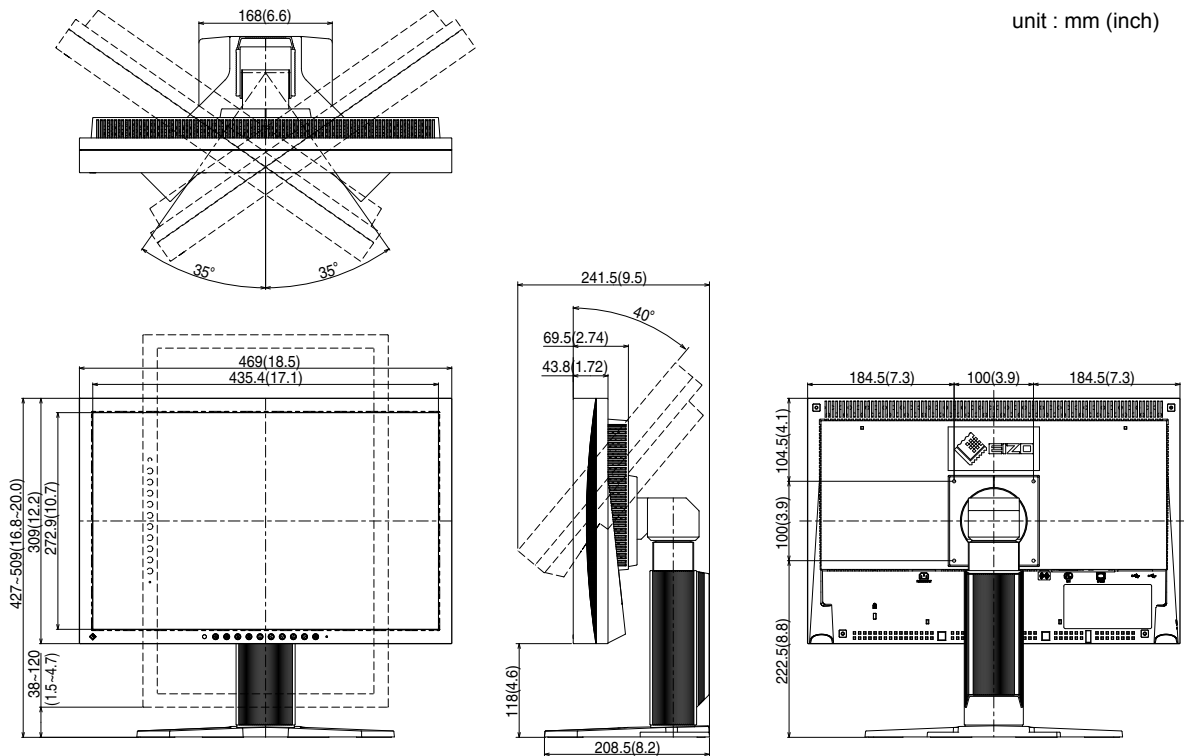

**S2001W (EZ-UP stand)**

unit : mm (inch)

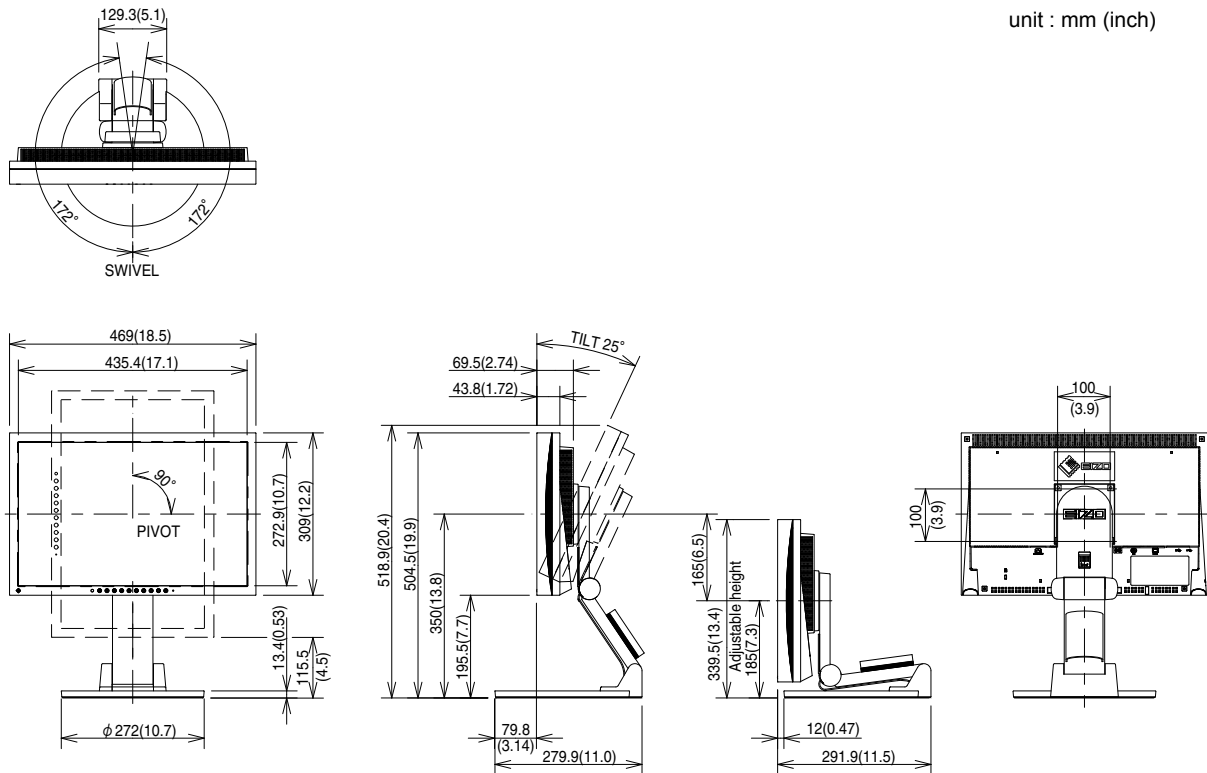

### S2201W (Height adjustable stand)

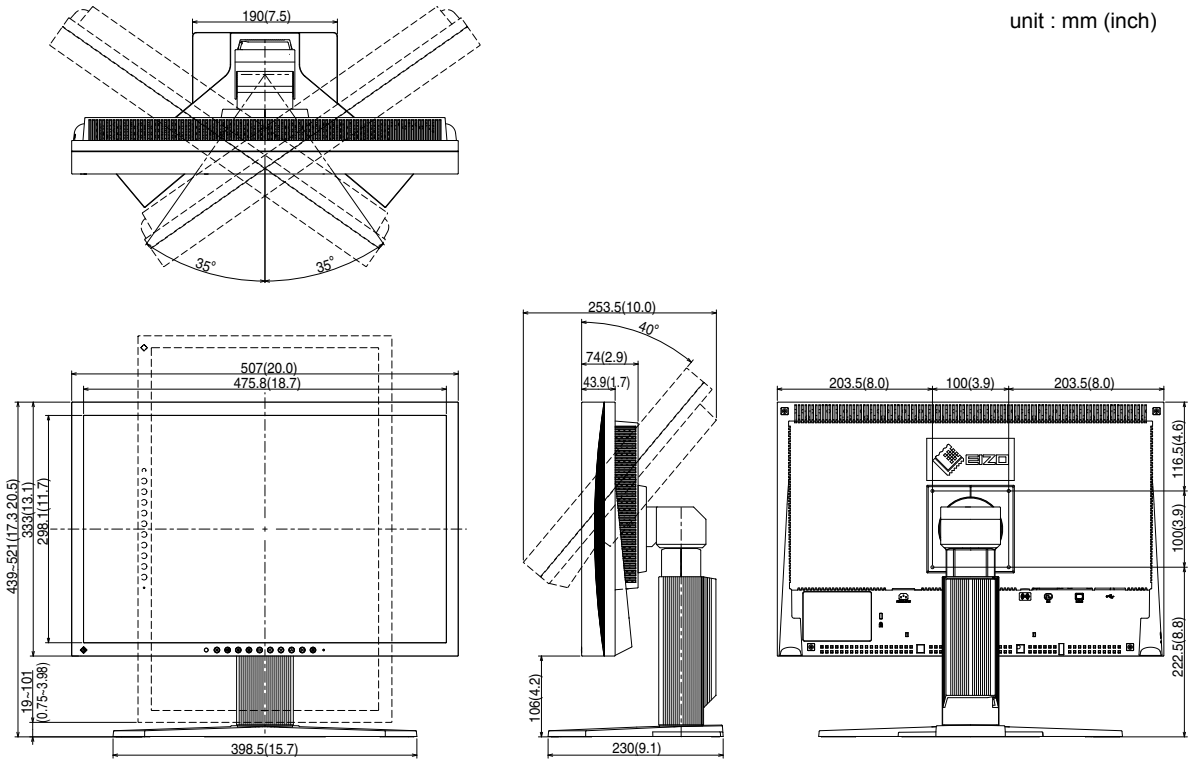

### S2201W (EZ-UP stand)

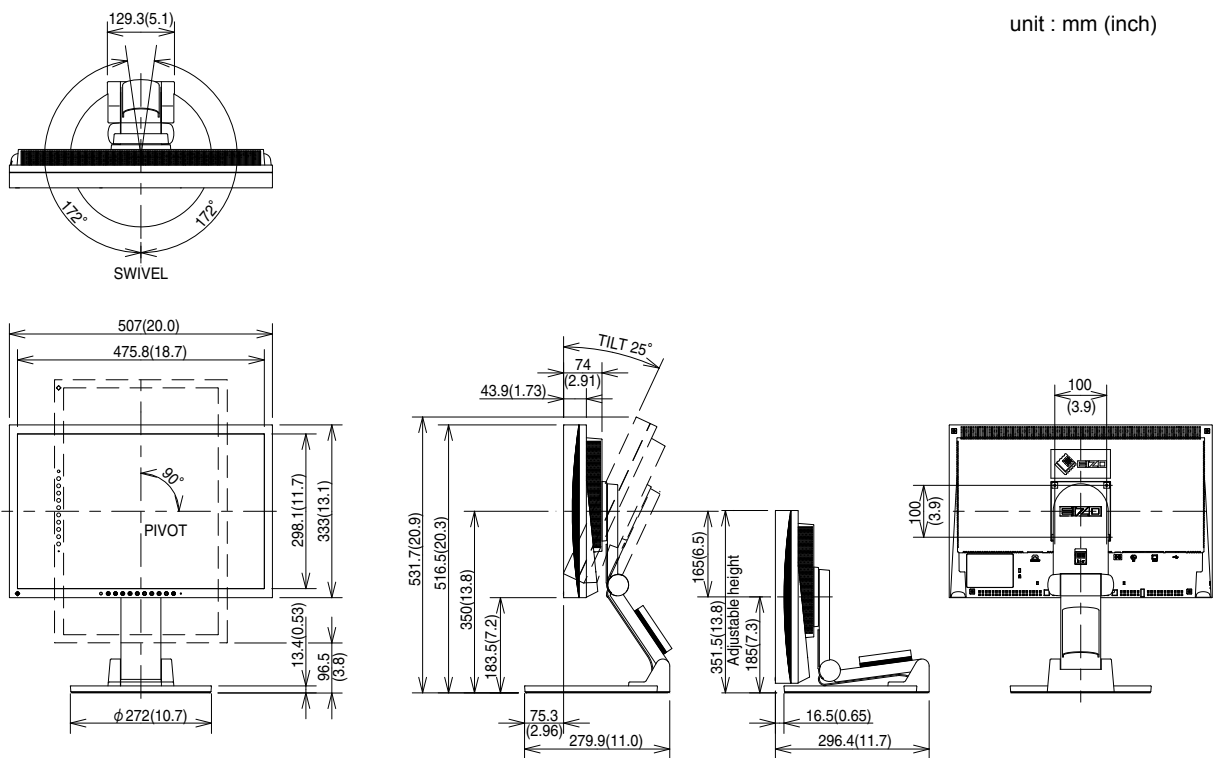

## Connector Pin Assignment

- DVI-I connector

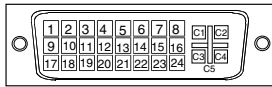

Pin No.	Signal	Pin No.	Signal	Pin No.	Signal
1	T.M.D.S. Data 2-	11	T.M.D.S. Data1/3 Shield	21	NC*
2	T.M.D.S. Data 2+	12	NC*	22	T.M.D.S. Clock shield
3	T.M.D.S. Data2/4 Shield	13	NC*	23	T.M.D.S. Clock+
4	NC*	14	+5V Power	24	T.M.D.S. Clock-
5	NC*	15	Ground (return for +5V, Hsync and Vsync)	C1	Analog Red
6	DDC Clock (SCL)	16	Hot Plug Detect	C2	Analog Green
7	DDC Data (SDA)	17	T.M.D.S. Data0-	C3	Analog Blue
8	Analog Vertical Sync	18	T.M.D.S. Data0+	C4	Analog Horizontal Sync
9	T.M.D.S. Data1-	19	T.M.D.S. Data0/5 Shield	C5	Analog Ground (analog R,G,&B return)
10	T.M.D.S. Data1+	20	NC*		

(NC\*: No Connection)

- D-sub mini 15-pin connector

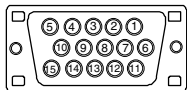

Pin No.	Signal	Pin No.	Signal	Pin No.	Signal
1	Red video	6	Red video ground	11	NC*
2	Green video or Green video + Composite Sync	7	Green video ground	12	Data (SDA)
3	Blue video	8	Blue video ground	13	H. Sync
4	NC*	9	NC*	14	V. Sync
5	Ground	10	Ground	15	Clock (SCL)

(NC\*: No Connection)

- USB port

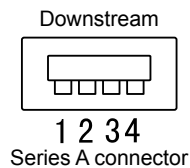
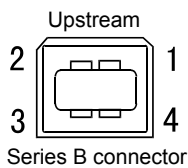

Contact No.	Signal	Remarks
1	VCC	Cable power
2	- Data	Serial data
3	+ Data	Serial data
4	Ground	Cable ground

### Option List

Cleaning Kit	EIZO ScreenCleaner
Signal Cable	FD-C16 FD-C39
Speaker Unit	i•Sound L3

## 5-4 Glossary

### Clock

The analog input monitor needs to reproduce a clock of the same frequency as the dot clock of the graphics system in use, when the analog input signal is converted to a digital signal for image display.

This is called clock adjustment. If the clock pulse is not set correctly, some vertical bars appear on the screen.

### DDC/CI (Display Data Channel/Command Interface)

VESA provides the standardization for the interactive communication of the setting information, etc. between a PC and the monitor.

### DVI (Digital Visual Interface)

DVI is a digital interface standard. DVI allows direct transmission of the PC's digital data without loss.

This adopts the TMDS transmission system and DVI connectors. There are two types of DVI connectors. One is a DVI-D connector for digital signal input only. The other is a DVI-I connector for both digital and analog signal inputs.

### DVI DMPM (DVI Digital Monitor Power Management)

DVI DMPM is a digital interface power-saving function. The "Monitor ON (operating mode)" and "Active Off (power-saving mode)" are indispensable for DVI DMPM as the monitor's power mode.

### Gain

This is used to adjust each color parameter for red, green and blue. An LCD monitor displays the color by the light passing through the panel color filter. Red, green and blue are the three primary colors. All the colors on the screen are displayed by combining these three colors. The color tone can be changed by adjusting the light intensity (volume) passing through each color's filter.

### Gamma

Generally, the monitor brightness varies nonlinearly with the input signal level, which is called "Gamma Characteristic". A small gamma value produces a low-contrast image, while a large gamma value produces a high-contrast image.

### HDCP (High-bandwidth Digital Contents Protection)

Digital signal coding system developed to copy-protect the digital contents, such as video, music, etc. This helps to transmit the digital contents safely by coding the digital contents sent via DVI terminal on the output side and decoding them on the input side.

Any digital contents cannot be reproduced if both of the equipments on the output and input sides are not applicable to HDCP system.

### Phase

Phase means the sampling timing to convert the analog input signal to a digital signal. Phase adjustment is made to adjust the timing. It is recommended that phase adjustment be made after the clock is adjusted correctly.

### Range Adjustment

Range adjustment controls the signal output levels to display every color gradation. It is recommended that range adjustment be made before color adjustment.

### Resolution

The LCD panel consists of numerous pixels of specified size, which are illuminated to form images. This monitor consists of 1680 horizontal pixels and 1050 vertical pixels. At a resolution of 1680 x 1050, all pixels are illuminated as a full screen (1:1).



**sRGB (Standard RGB)**

International standard for “color reproduction and color space” among peripheral devices (such as monitors, printers, digital cameras, scanners). sRGB allows Internet users to closely match colors as a simple color matching means for the Internet use.

**Temperature**

Color temperature is a method to measure the white color tone, generally indicated in degrees Kelvin. The screen becomes reddish at a low temperature, and bluish at a high temperature, like the flame temperature.

5000K: Slightly reddish white

6500K: Warm white like paper white

9300K: Slightly bluish white

**TMD5 (Transition Minimized Differential Signaling)**

A signal transmission system for digital interface.

**VESA DPMS (Video Electronics Standards Association - Display Power Management Signaling)**

VESA provides the standardization of signals from PC (graphics board) for power saving of PC monitors. DPMS defines the signal status between PC and monitor.

## 5-5 Preset Timing

The following table shows factory preset video timing (for analog signal only).

Mode	Dot clock		Frequency	Polarity
			Horizontal: kHz Vertical: Hz	
VGA 640×480@60Hz	25.2 MHz	Horizontal	31.47	Negative
		Vertical	59.94	Negative
VGA 720×400@70Hz	28.3 MHz	Horizontal	31.47	Negative
		Vertical	70.09	Positive
Macintosh 640×480@67Hz	30.2 MHz	Horizontal	35.00	Negative
		Vertical	66.67	Negative
Macintosh 832×624@75Hz	57.3 MHz	Horizontal	49.72	Negative
		Vertical	74.55	Negative
Macintosh 1152×870@75Hz	100.0 MHz	Horizontal	68.68	Negative
		Vertical	75.06	Negative
Macintosh 1280×960@75Hz	126.2 MHz	Horizontal	74.76	Positive
		Vertical	74.76	Positive
VESA 640×480@72Hz	31.5 MHz	Horizontal	37.86	Negative
		Vertical	72.81	Negative
VESA 640×480@75Hz	31.5 MHz	Horizontal	37.50	Negative
		Vertical	75.00	Negative
VESA 640×480@85Hz	36.0 MHz	Horizontal	43.27	Negative
		Vertical	85.01	Negative
VESA 800×600@56Hz	36.0 MHz	Horizontal	35.16	Positive
		Vertical	56.25	Positive
VESA 800×600@60Hz	40.0 MHz	Horizontal	37.88	Positive
		Vertical	60.32	Positive
VESA 800×600@72Hz	50.0 MHz	Horizontal	48.08	Positive
		Vertical	72.19	Positive
VESA 800×600@75Hz	49.5 MHz	Horizontal	46.88	Positive
		Vertical	75.00	Positive
VESA 800×600@85Hz	56.3 MHz	Horizontal	53.67	Positive
		Vertical	85.06	Positive
VESA 1024×768@60Hz	65.0 MHz	Horizontal	48.36	Negative
		Vertical	60.00	Negative
VESA 1024×768@70Hz	75.0 MHz	Horizontal	56.48	Negative
		Vertical	70.07	Negative
VESA 1024×768@75Hz	78.8 MHz	Horizontal	60.02	Positive
		Vertical	75.03	Positive
VESA 1024×768@85Hz	94.5 MHz	Horizontal	68.68	Positive
		Vertical	85.00	Positive
VESA 1152×864@75Hz	108.0 MHz	Horizontal	67.50	Positive
		Vertical	75.00	Positive
VESA 1280×960@60Hz	108.0 MHz	Horizontal	60.00	Positive
		Vertical	60.00	Positive
VESA 1280×1024@60Hz	108.0 MHz	Horizontal	63.98	Positive
		Vertical	60.02	Positive
VESA 1280×1024@75Hz	135.0 MHz	Horizontal	79.98	Positive
		Vertical	75.03	Positive
VESA CVT 1680×1050@60Hz	146.3 MHz	Horizontal	65.29	Negative
		Vertical	59.95	Positive
VESA CVT RB 1680×1050@60Hz	119.0 MHz	Horizontal	64.67	Positive
		Vertical	59.88	Negative

### Attention

- Display position may be deviated depending on the PC connected, which may require screen adjustment using Adjustment menu.
- If a signal other than those listed in the table is input, adjust the screen using the Adjustment menu. However, screen display may still be incorrect even after the adjustment.
- When interlace signals are used, the screen cannot be displayed correctly even after screen adjustment using the Adjustment menu.



Congratulations!

The display you have just purchased carries the TCO'03 Displays label. This means that your display is designed, manufactured and tested according to some of the strictest quality and environmental requirements in the world. This makes for a high performance product, designed with the user in focus that also minimizes the Impact on our natural environment.

Some of the features of the TCO'03 Display requirements:

#### Ergonomics

- Good visual ergonomics and image quality in order to improve the working environment for the user and to reduce sight and strain problems. Important parameters are luminance, contrast, resolution, reflectance, colour rendition and image stability.

#### Energy

- Energy-saving mode after a certain time - beneficial both for the user and environment
- Electrical safety

#### Emissions

- Electromagnetic fields
- Noise emissions

#### Ecology

- The products must be prepared for recycling and the manufacturer must have a certified environmental management system such as EMAS or ISO 14000
- Restrictions on
  - chlorinated and brominated flame retardants and polymers
  - heavy metals such as cadmium, mercury and lead.

The requirements included in this label have been developed by TCO Development in co-operation with scientists, experts, users as well as manufacturers all over the world. Since the end of the 1980s TCO has been involved in influencing the development of IT equipment in a more user-friendly direction. Our labeling system with displays in 1992 and is now requested by users and IT-manufacturers all over the world.

**For more information, please visit  
[www.tcodevelopment.com](http://www.tcodevelopment.com)**

For U.S.A. , Canada, etc. (rated 100-120 Vac) Only

## FCC Declaration of Conformity

**We, the Responsible Party**

EIZO NANAOTECHNOLOGIES INC.

5710 Warland Drive, Cypress, CA 90630

Phone: (562) 431-5011

**declare that the product**

Trade name: EIZO

Model: FlexScan S2001W/S2201W

**is in conformity with Part 15 of the FCC Rules. Operation of this product is subject to the following two conditions: (1) this device may not cause harmful interference, and (2) this device must accept any interference received, including interference that may cause undesired operation.**

This equipment has been tested and found to comply with the limits for a Class B digital device, pursuant to Part 15 of the FCC Rules. These limits are designed to provide reasonable protection against harmful interference in a residential installation. This equipment generates, uses, and can radiate radio frequency energy and, if not installed and used in accordance with the instructions, may cause harmful interference to radio communications. However, there is no guarantee that interference will not occur in a particular installation. If this equipment does cause harmful interference to radio or television reception, which can be determined by turning the equipment off and on, the user is encouraged to try to correct the interference by one or more of the following measures.

- \* Reorient or relocate the receiving antenna.
- \* Increase the separation between the equipment and receiver.
- \* Connect the equipment into an outlet on a circuit different from that to which the receiver is connected.
- \* Consult the dealer or an experienced radio/TV technician for help.

Changes or modifications not expressly approved by the party responsible for compliance could void the user's authority to operate the equipment.

### Note

Use the attached specified cable below or EIZO signal cable with this monitor so as to keep interference within the limits of a Class B digital device.

- AC Cord
- Shielded Signal Cable (enclosed)

## Canadian Notice

This Class B digital apparatus complies with Canadian ICES-003.

Cet appareil numérique de la classe B est conforme à la norme NMB-003 du Canada.

### **Hinweise zur Auswahl des richtigen Schwenkarms für Ihren Monitor**

Dieser Monitor ist für Bildschirmarbeitsplätze vorgesehen. Wenn nicht der zum Standardzubehör gehörige Schwenkarm verwendet wird, muss statt dessen ein geeigneter anderer Schwenkarm installiert werden. Bei der Auswahl des Schwenkarms sind die nachstehenden Hinweise zu berücksichtigen:

Der Standfuß muß den nachfolgenden Anforderungen entsprechen:

- a) Der Standfuß muß eine ausreichende mechanische Stabilität zur Aufnahme des Gewichtes vom Bildschirmgerät und des spezifizierten Zubehörs besitzen. Das Gewicht des Bildschirmgerätes und des Zubehörs sind in der zugehörigen Bedienungsanleitung angegeben.
- b) Die Befestigung des Standfusses muß derart erfolgen, daß die oberste Zeile der Bildschirmanzeige nicht höher als die Augenhöhe eines Benutzers in sitzender Position ist.
- c) Im Fall eines stehenden Benutzers muß die Befestigung des Bildschirmgerätes derart erfolgen, daß die Höhe der Bildschirmmitte über dem Boden zwischen 135 – 150 cm beträgt.
- d) Der Standfuß muß die Möglichkeit zur Neigung des Bildschirmgerätes besitzen (max. vorwärts: 5°, min. nach hinten  $\geq 5^\circ$ ).
- e) Der Standfuß muß die Möglichkeit zur Drehung des Bildschirmgerätes besitzen (max.  $\pm 180^\circ$ ). Der maximale Kraftaufwand dafür muß weniger als 100 N betragen.
- f) Der Standfuß muß in der Stellung verharren, in die er manuell bewegt wurde.
- g) Der Glanzgrad des Standfusses muß weniger als 20 Glanzeinheiten betragen (seidenmatt).
- h) Der Standfuß mit Bildschirmgerät muß bei einer Neigung von bis zu 10° aus der normalen aufrechten Position kippstabil sein.

### **Hinweis zur Ergonomie :**

Dieser Monitor erfüllt die Anforderungen an die Ergonomie nach EK1-ITB2000 mit dem Videosignal, 1920 × 1200, RGB analog, 0,7 Vp-p und mindestens 60,0 Hz Bildwiederholfrequenz, non interlaced. Weiterhin wird aus ergonomischen Gründen empfohlen, die Grundfarbe Blau nicht auf dunklem Untergrund zu verwenden (schlechte Erkennbarkeit, Augenbelastung bei zu geringem Zeichenkontrast.)

Übermäßiger Schalldruck von Ohrhörern bzw. Kopfhörern kann einen Hörverlust bewirken.

Eine Einstellung des Equalizers auf Maximalwerte erhöht die Ausgangsspannung am Ohrhörer- bzw. Kopfhörerausgang und damit auch den Schalldruckpegel.

„Maschinenlärminformations-Verordnung 3. GPSGV:

Der höchste Schalldruckpegel beträgt 70 dB(A) oder weniger gemäss EN ISO 7779“

[Begrenzung des maximalen Schalldruckpegels am Ohr]  
Bildschirmgeräten: Größte Ausgangsspannung 150 mV



#### **EIZO NANA O CORPORATION**

153 Shimokashiwano, Hakusan, Ishikawa 924-8566 Japan  
Phone: +81 76 277 6792 Fax: +81 76 277 6793

#### **EIZO NANA O TECHNOLOGIES INC.**

5710 Warland Drive, Cypress, CA 90630, U.S.A.  
Phone: +1 562 431 5011 Fax: +1 562 431 4811

#### **EIZO EUROPE AB**

Lovangsvagen 14 194 61, Upplands Väsby, Sweden  
Phone: +46 8 590 80 000 Fax: +46 8 590 91 575

#### **EIZO NANA O AG**

Moosacherstrasse 6, Au CH - 8820 Wadenswil, Switzerland  
Phone: +41-0-44 782 24 40 Fax: +41-0-44 782 24 50

#### **Avnet Technology Solutions GmbH**

Lötscher Weg 66, D-41334 Nettetal, Germany  
Phone: +49 2153 733-400 Fax: +49 2153 733-483

<http://www.eizo.com>



1st Edition-August, 2007

03V22179A1  
(U.M-S2001W)