

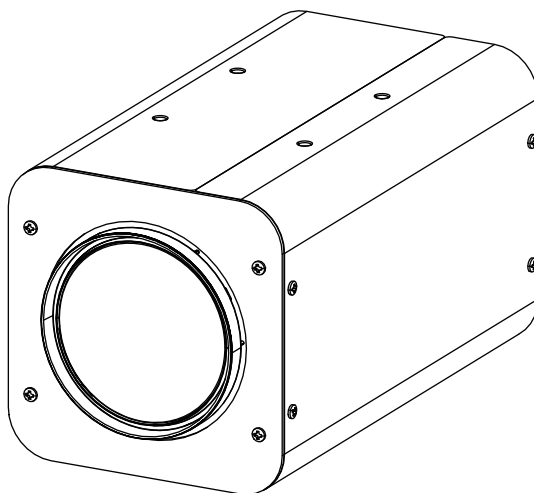

SSZ-9700

Instruction Manual



Thank you for purchasing this product.

Please read this manual carefully before using to ensure proper use of this product.

Be sure to read "Safety Precautions" in particular to use the product safely.





Please keep the manual at hand after reading and read it when necessary.

Table of Contents



Safety Notice	3
Precautions	4
Storage and Operating Environment	4
Transportation	5
Maintenance	5
Phenomena Specific to CMOS Image Sensors	5
Phenomena Specific to Lens	5
Others	6
Disclaimer	6
Contents of This Manual	6
Introduction	7
Features	7
Names and Functions of Parts	8
Operation	9
User Setup	9
Names and Functions of Setup Buttons	9
Structure of Setup Mode	9
Contents of Main Menu	9
Main Menu	9
ALC Menu	10
Picture Menu	12
Color Menu	14
Lens Menu	15
Video Output Menu	16
Device Setting (1/2) Menu	17
Device Setting (2/2) Menu	19
Information: Version	20
Restrictions on Menu Setting	21
Menu Structure	22
Specifications	24
Dimensions	26
Recycling Information	27
Warranty Policy	30
Warning for Radio interference	31

Safety Notice

WARNING

	Mount this unit to a stable place with sufficient strength.
	Tighten all screws and locking mechanism firmly. If the screws are loose, this unit may fall resulting in injury. Falling from height may lead to serious accident.
	Use at correct power supply and voltage. The rated input voltage of this unit is DC 12 V. Supplying a power beyond the rated value may cause damage to this unit, and it may lead to smoke or fire at the worst. Input a voltage according to the rated voltage of the camera.
	This unit is able to divert lightning conduction to itself and the connecting cables to some extent, but this is not 100 % guaranteed. For installation locations subject to lightning strikes, make sure to apply lightning induction to the connecting cables.

CAUTION

	Avoid rubbing the metal edge. Rubbing too hard may lead to injury.
	If there is any abnormality such as smoke, abnormal noise or foreign object, turn off the power supplied to the camera. Remove the camera and immediately contact the retailer where you purchased the product.
	Do not disassemble or modify. Doing so may impair the functions of the product or cause an electric shock.

Precautions

Storage and Operating Environment

- This unit is intended for indoor use only. Do not use it outdoor.
- Do not shoot extremely bright subjects (such as lighting and sun) for long periods of time. And avoid placing the product in the following locations. Doing so may result in unwanted operation or malfunction.
 - Extremely hot or cold places (Operating temperature: -10 °C to +50 °C [14 °F to 122 °F])
 - Extremely humid places (Operating humidity: 35 %RH to 90 %RH, without condensation)
 - Near strong magnetic field sources such as transformer or motor
 - Near radio wave sources such as transceivers or cellular phones
 - Near TV or radio transmitters that emit strong radio waves
 - Locations affected by reflections from fluorescent lights and window
 - Locations where unstable lighting is used (where flicker occurs)
 - Locations that reflects laser light
 - Near high-voltage lines and railroad tracks
 - Extremely dusty or sandy locations
 - Locations subject to strong vibration or shock, such as inside vehicles or ships
 - Locations exposed to rain or condensation, such as window side.
 - Locations subject to steam or oil, such as kitchens.
 - Special environment such as in combustible atmosphere
 - Locations where radiation, X-rays, salt attack or corrosive gases occur
 - Locations where chemicals are used, such as pools and hot springs
- If this unit and the cable connected to this unit are used in a location where strong radio waves or magnetism are generated (e.g., near a radio, TV, transformer, railroad track, monitor, etc.), noise or beats may appear in the image and change its color.
- Insufficient heat dissipation from this unit may lead to malfunction. To prevent heat buildup, do not block air circulation around this unit. This unit dissipate heat from the surface (side) of the main unit. Do not install this unit at a location where heat is trapped, such as near a wall.
- Do not install this unit at a location exposed to cold air, such as near the air outlet of an air conditioner.
- When using in the following conditions and environments, do contact us and pay attention to safety measures.
 - Use in conditions and environment other than the specifications stated or outdoor.
 - Use for applications that are expected to have a significant impact on people and property and require specific safety.
- This unit is used under various conditions, do perform analysis and testing as necessary before making a decision although the suitability of the device or equipment have been decided by the designer of the device or equipment or the person who decides the specifications. The performance and safety of this device or equipment should be guaranteed by the customer who has determined the compatibility with the device or equipment.
- This unit is not designed and manufactured to be used for controlling devices that directly affect someone's life (*1) or devices that are involved in one's safety and have a significant impact on the maintenance of public functions (*2). Do not use for those purposes.
 - *1 Devices that directly affect someone's life are as follows.
 - Medical equipment such as life support machines and operating room equipment
 - Exhaust gas such as toxic gas, smoke exhaust device
 - Devices that are required to be installed by various laws and regulations such as the fire legislation and building regulations
 - Devices based on the above stated

*2 Devices that are involved in one's safety and have a significant impact on the maintenance of public functions are as follows.

- Traffic control equipment for aviation, railroads, roads, shipping, etc.
- Equipment such as nuclear power plants
- Devices based on the above stated

Transportation

- Always turn off the power before moving this unit.
- Handle the unit with care and avoid heavy shock or vibration.

Maintenance

- Remove dust or dirt on the surface of the lens with a blower (commercially available). Do not use a spray type blower to clean the lens as water droplets may splatter into the lens. Pay careful attention when cleaning the lens.

Phenomena Specific to CMOS Image Sensors

- The following phenomena that may appear in images are specific to CMOS (complementary metal-oxide semiconductor) image sensors. They do not indicate malfunctions.
 - White Spots
Although the CMOS image sensors are produced with high-precision technologies, fine white spots may be generated on the screen in rare cases, caused by cosmic rays, etc. This is due to the principle of CMOS image sensors and is not a malfunction. The white spots tend to be seen especially in the following cases:
 - When operating at a high environmental temperature
 - When the shutter speed is slowed down
 - When you have raised the master gain (sensitivity)
 - Aliasing
When fine patterns, stripes, or lines are shot, they may appear jagged or flicker.

Phenomena Specific to Lens

- The following phenomenon that may appear in images is specific to a lens and is not a malfunction.
 - Ghosting
When bright light source like the sun is near the angle of incidence of the lens, extremely bright shadows may appear in the image due to diffuse reflection within the lens.

Others

- For safety and power saving purposes, turn off the system when it will not be used for a long time.
- This unit is a precision instrument, do not subject to strong impact.
- Attach the lens cap to the lens when the camera will not be used for a long time.
- This unit is designed to be used indoor. Be sure to take protective measures for the lens such as attaching a protective cover when using it outdoor.
- We recommend that a cable connected to the DC power terminal and RS-485 port be 3 meters or less.

Disclaimer

- We will not be responsible for any inconveniences or disturbances caused in the event of privacy invasion as a result of camera footages of this product.
- We do not accept liability for the damage of recording or storing image and/or the missing opportunity of recording in the case caused by a problem of this unit.
- Before starting an important recording, make sure to take a test recording in order to confirm a normal recording possible.
- We are not liable for any damages caused by earthquakes, fires, acts by third parties, other accidents, by deliberate intention or negligence of the customer, misuse, or use under other abnormal conditions.
- We are not liable for any damages caused by malfunctions due to the use with any connected devices (including image processing boards and lenses) and software that we are not involved in.
- We will not take any responsibility for infringement or damage if violation of privacy occurred due to the camera image of this unit.
- We are not liable for any damage caused by prolonged recording with AF Mode set to Auto.
- Please note that we are not responsible for any damage to your hardware or software caused by the software provided by us or your own application software.
- We are not liable for any damages caused by not observing the contents in the specification and instruction manual.
- We are not liable for any damages caused by operating methods other than those described in the specification and instruction manual.
- We are not liable for any damages caused by repairs or modifications by the customer or an unauthorized third party (non-designated service shop, etc.).
- In any case, the cost we bear for this product shall be within the price of this product.

Contents of This Manual

- The specifications and/or appearance of the product are subject to change without prior notice.
- “Carina System” is the registered trademark of Carina System Co., Ltd.
- Other product names are trademarks or registered trademarks of their respective companies.

Introduction

This unit is an ultra-sensitive single-panel color camera equipped with a 35x optical zoom lens that covers a focal length from wide angle 6.5 mm to telephoto 230 mm, and it uses a 2.12 million pixel 1/1.8-inch CMOS sensor. Ideal for surveillance or security measures and environmental surveys in low light areas at night for borders, harbors and other special purposes.

Features

- Enables color imaging with high sensitivity under low-light conditions, down to 0.004 lx.
- Maintains excellent SN ratio even at high-gain settings, with the original 2D/3D noise reduction function.
- Achieves a maximum zoom ratio of up to 350x (f = 10500mm in 35mm equivalent) by combining a 35x optical zoom lens and 10x digital zoom (when using digital zoom, resolution is reduced).
- Enables recording of clear images under hazy condition with the optical Defog function by an infrared light transmission filter.
- Enables recording under significant brightness difference condition with the HDR function.
- Capable of establishing an advanced surveillance system with the RS-485 communication function.

Names and Functions of Parts

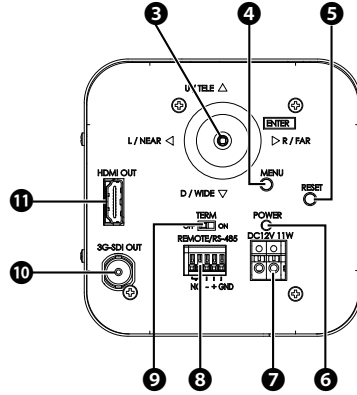
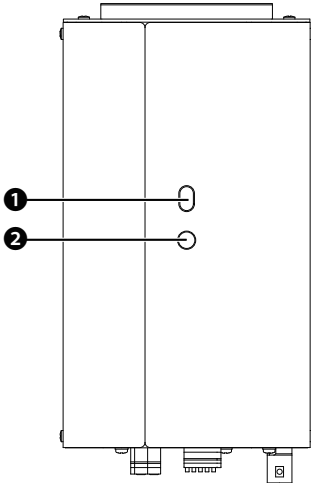

- 1 Securing Hole**
Can be used to prevent rotation.
- 2 Tripod Socket**
Socket for securing onto a tripod etc. Use 1/4"-20 UNC screws with length of 5.5 mm or less.
- 3 Arrow Buttons**
Refer to the menu operation. (→ P 9)
- 4 MENU Button**
Refer to the menu operation. (→ P 9)
- 5 RESET Button**
Reboots the camera when it is pressed.
- 6 Power Indicator**
Lights up in green when the camera is turned on.
- 7 DC 12 V Connection Terminal Block**
Input DC 12 V. (No polarity)
- 8 RS-485**
Use for remote controlling via RS-485.

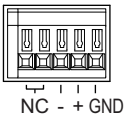

- 9 RS-485 Terminal Switch**
During RS-485 communication, set to "ON" for one-to-one control and "OFF" for daisy-chain connection. (Last connection device is ON)
- 10 3G-SDI Output Terminal**
Image output terminal for 3G-SDI.
- 11 HDMI Output Terminal**
Image output terminal for HDMI.

Operation

User Setup

Setup menu can be set on the OSD display.

Names and Functions of Setup Buttons

Operate using the Arrow buttons (figure on the right) on the back of the camera. Use the Arrow buttons to move up, down, left and right to the item you want to select, and press the Arrow button (OK button) to confirm.

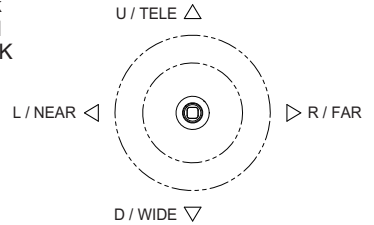

Structure of Setup Mode

The setup menu consists of 7 items of setup menu.

Contents of Main Menu

The menu's initial screen (Main Menu) appears when the MENU button is pressed. Various settings for the camera operation are available. To close the menu screen, press the MENU button again or select EXIT.

Main Menu

Main Menu		
ALC	Setup	↵
Picture	Setup	↵
Color	Setup	↵
Lens	Setup	↵
Video Output	Setup	↵
Dev. Setting	Setup	↵
Information	Disp	↵
EXIT		

ALC Menu

ALC	
ALC Mode	Full Auto
ALC Level 100
Limits	Setup ↵
Shutter	1/60
Gain	0.0dB
Iris	F**
BLC Mode	Off
Detailed	Settings ↵
RETURN	EXIT

ALC Mode

For selecting the method to control the brightness.

Full Auto

The gain, shutter speed and iris are automatically adjusted.

Shut.Prio.

The gain and iris are automatically adjusted and the shutter speed can be adjusted to any setting value.

Gain Prio.

The shutter speed and iris are automatically adjusted and the gain can be adjusted to any setting value.

Iris Prio

The gain and shutter speed are automatically adjusted and the iris can be adjusted to any setting value.

Manual

The gain, shutter speed and iris can be adjusted to any setting value.

ALC Level

Adjust the convergence value for automatic exposure using the Arrow buttons. Moving the lever to the right enhances the brightness. Adjust to the appropriate position while looking at the actual image.

Limits

Adjust the maximum and minimum values of shutter speed, gain, and iris to any setting value during automatic adjustment.

Shutter

When ALC Mode is set to Shut.Prio. or Manual, use the Arrow buttons to adjust any value setting for the shutter speed.

- 1/1, 1/2, 1/4, 1/8, 1/15, 1/30, 1/60, 1/100, 1/125, 1/250, 1/500, 1/1000, 1/2000, 1/4000, 1/10000 [59.94 Hz system]
- 1/1, 1/2, 1/3, 1/6, 1/12, 1/25, 1/50, 1/100, 1/125, 1/250, 1/500, 1/1000, 1/2000, 1/4000, 1/10000 [50 Hz system]

* There is a margin of error in the displayed value of the shutter speed and the actual control.

Gain

When ALC Mode is set to Gain Prio. or Manual, use the Arrow buttons to adjust any setting value for the gain.

- 0 to 78 dB (in step of 0.3 dB)

Iris

When ALC Mode is set to Iris Prio. or Manual, use the Arrow buttons to adjust any setting value for the iris.

- F1.5, F2, F2.8, F4, F5.6, F8, F11, F16, F22

BLC Mode

The backlight correction can be set using the Arrow buttons.

Off

Adjusts the best brightness for the entire screen.

On

Automatically corrects the brightness by measuring the light while avoiding extremely bright areas on the entire screen.

Spot

Automatically selects an area surrounded by a frame on the screen and corrects the brightness so that the other areas are in the best condition.

When entering SPOT SET, a 9×5 grid appears on the screen.

Move the cursor using the Arrow buttons and press the Arrow button at the required position to fill in the grid. The filled area is excluded from photometry.

Detailed Settings

Flickerless

Allows you to turn on or off the flicker improvement function.

- Fixed at 1/100s for the 59.94 Hz system and 1/60s for the 50 Hz system

Day/Night

Allows you to select a IR cut filter switching specification from the following modes.

Color

Outputs color images (with IR cut) at all times.

B/W

Outputs monochrome images (without IR cut) at all times.

Auto

Automatically switches to color images of high quality during daytime and black-and-white images of high sensitivity at night.

After selecting this mode, Switch Level (switching brightness level) can be set by pressing the OK button.

Switch Level Setting

For setting the switching brightness level.

Dark

The switching brightness level is dark.

Mid

The switching brightness level is between Dark and Bright.

Bright

The switching brightness level is bright.

Manual

The switching brightness level is set manually.

Manual Setting

When Switch Level is set to Manual, the following settings can be performed.

Color⇒B/W

Sets the brightness to switch from day to night.

B/W⇒Color

Sets the brightness to switch from night to day.

Average/Peak

Allows you to adjust the average value and peak value of the metering data.

Picture Menu

Picture	
HDR	Off
Auto Knee	Off
Auto B.str	Off
Black Level 0
Gamma	0.45
Fog	Off
DNR	High
Detail 50
RETURN	EXIT

HDR

Allows you to turn on or off HDR (function that expresses a wide range of brightness by double exposure of low-speed shutter and high-speed shutter).

On

HDR Mode

Selecting On allows you to adjust the following items. The following items are not displayed when Off is selected.

* The frame rate of the image sensor is 1/2 in the HDR mode.

- **Shut Ratio**

Allows you to adjust the shutter ratio between low speed and high speed.

- **Mix Pos.**

Allows you to select Auto, Low or High as the switching point between the low speed shutter image and high speed shutter image.

Auto

Automatically sets the switching point between low speed and high speed.

Low

The switching point is based on the high speed shutter.

High

The switching point is based on the low speed shutter.

Off

Normal Mode

Auto Knee

Allows you to automatically compress and display the bright area.

On

It lowers the knee point to about 80 IRE and automatically adjusts the knee slope according to the brightness.

Off

The knee point is fixed at about 100 IRE.

Auto B str.

Allows you to turn on or off the function to stretch and display the dark area.

On

Sets Auto Black Stretch to ON.

Off

Normal Mode

Black Level

The black level of the camera image can be adjusted using the Arrow buttons.

Gamma

Allows you to select the gamma characteristics for the camera according to the display (monitor) used.

- 0.35 to 0.55 (0.01 step)/ 1.0

Fog

Even when the background and/or the contour of the subject are among fog, haze, or smoke, as long as they are slightly visible, the function corrects the image by providing contrast so that they become more visible. The image can also be made more visible by using an infrared light transmission filter concurrently.

Opt.DefogH

Defog function via infrared light transmission filter and electronically; high correction level.

Opt.DefogM

Defog function via infrared light transmission filter and electronically; medium correction level.

Opt.DefogL

Defog function via infrared light transmission filter and electronically; low correction level.

Opt.Defog

Defog function via infrared light transmission filter.

Off

Normal mode.

Low

Digital Defog function; low correction level.

Mid

Digital Defog function; medium correction level.

High

Digital Defog function; high correction level.

* When using an infrared light transmission filter, the screen becomes monochrome.

DNR

Select the noise reduction effect using the Arrow buttons.

Off

Noise reduction does not operate.

Low

Noise reduction operates on LOW.

High

Noise reduction operates on HIGH.

* The amount of noise reduction operation operates in proportion to the amount of gain. When Gain is low, the amount of noise reduction operation is small and when Gain is high, the amount of noise reduction operation is large.

* When the Gain is increased by selecting High, an afterimage may occur under the influence of 3D noise reduction.

Detail

The contour enhancement level of the camera image can be adjusted using the Arrow buttons.

Color Menu

	Color	
White Bal.	Manual	
Red Gain	50
Blue Gain	50
Chroma	50
Color Matrix	Setup	
RETURN	EXIT	

White Bal

Allows you to switch the white balance mode using the Arrow buttons.

ATW1

Automatically tracks and adjusts white balance. (Color temperature range: 2500K to 9000K)

ATW2

Automatically tracks and adjusts white balance. Although it supports a wider range of color temperatures than ATW1, the color may shift compared to ATW1.

AWC

One push auto white balance control.

Align white balance by projecting the target achromatic (white, gray) subject and pressing the Arrow button.

Manual

Preferred white balance is acquired by adjusting Red Gain and Blue Gain.

Red Gain

When White Bal is set to Manual, you can adjust the red color using the Arrow buttons.

Blue Gain

When White Bal is set to Manual, you can adjust the blue color using the Arrow buttons.

Low Temp.

This is the balance that matches the light source of the warm color system 3200K.

High Temp.

This is the balance that matches the light source of the cool color system 5000K.

Chroma

The chroma level of the camera image can be adjusted using the Arrow buttons.

Color Matrix

Allows you to adjust the hue and saturation of six axes: R, G, B, Ye, Cy, and Mg.
After selecting each color, use the Arrow buttons to adjust the Hue and Saturation.

Lens Menu

	Lens		
Zoom Speed		1
Zoom Move			
E-Zoom Mode	Max x4		
Focus Speed		1
Focus Move	N< >F		
AF Mode	Auto		
RETURN	EXIT		

Zoom Speed

The movement speed of the zoom lens can be adjusted using the Arrow buttons.

Zoom Move

The zoom lens can be adjusted using the Arrow buttons.

E-Zoom Mode

Allows you to set the digital zoom from the following modes.

Off

An optical zoom (35x) only.

Max x4

An optical zoom and the digital zoom (4x) can be combined to zoom up to 140x.

Max x10

An optical zoom and the digital zoom (10x) can be combined to zoom up to 350x.

Focus Speed

The movement speed of the focus lens can be adjusted using the Arrow buttons.

Focus Move

The focus lens can be adjusted using the Arrow buttons.

AF Mode

Allows you to select the auto focus from the following modes.

Auto

This is the mode in which normal auto focus is always functioning.

One Push AF

The auto focus functions only when you press and hold the Arrow button.

Manual

Adjust the focus lens manually by moving left and right using the Arrow buttons to focus.

Caution : _____

- It may be difficult to focus using auto focus depending on the condition of the subject. In that case, use Manual to focus.
You may not be able to focus using auto focus especially when the subject is dark, there is a lot of noise, the contrast is low, or the lens is dirty.
- Prolonged recording with AF Mode set to Auto can affect the lifespan of the lens control motor. We recommend setting AF Mode to One Push AF or Manual.

Video Output Menu

Video Output	
Video Format	1080p/59.94 ↵
HDMI Color	RGB(Limit) ↵
Flip/Mirror	Normal
Video Test	Camera
RETURN	EXIT

Video Format

Allows you to change the signal format of the HD output.

If you change the setting, an "Enter symbol" is displayed. Press the Arrow button to display the confirmation screen.

Selecting OK restarts the camera and switches the format. There is no video output during the restart.

HDMI Color Space

Allows you to select the color space of the HDMI output.

You can select from RGB(Limit), RGB(Full) and YUV422.

If you change the setting, an "Enter symbol" is displayed. Press the Arrow button to display the confirmation screen.

Selecting OK changes the color space setting.

Flip / Mirror

Allows you to reverse the image.

Normal

Normal mode.

Flip

Flips the image vertically.

Mirror

Flips the image horizontally.

Frip&Mirror

Flips the image vertically and horizontally.

Video Test

Camera

Normal state

Gray Scale

Gray scale signal

Color Bar

Color bar signal

Cross Line

Cross line signal

Device Setting (1/2) Menu

Dev. Setting (Page 1/2)		
Camera ID	On	↵
RS485 ID	1	
RS485 Baud.	9600	↵
Setting to Default		↵
RETURN	EXIT	NEXT

Camera ID

Displays the camera ID when this item is set to On.

Pressing the Arrow button to set to On activates the edit mode and the following screen appears.

Press the Arrow button at the cursor position (flashing) to perform the following operation.

Edit Camera ID			
ABCDEFGHIJKLMN —	OPQRSTU —	V — 1	
WXYZ : 0 _ / + - . 1 2 3 4 5 6 7 8 9			
+	+++++		2
←	→	—————	3
SPACE	DELETE	CLEAR	4
RETURN	POSITION	NEXT	5

1 The character is entered when you press the Arrow button at the cursor position.

2 The character entered appears.

3 Change the position of the character to enter.

4 Enter a blank space / Delete a character / Delete all characters.

5 Set the display position.

After selecting the POSITION in step 5 and pressing the Arrow button, the ID appears on the display (monitor). You can move the position using the up, down, left and right Arrow buttons.

RS-485 ID

For setting the camera number when controlled via RS-485.

RS-485 Baud.

For setting the baud rate to be used when controlling the camera from a control equipment (PC etc.) via RS-485.

You can select from 9600bps, 19200bps and 38400bps.

If you change the setting, an "Enter symbol" is displayed. Press the Arrow button to display the confirmation screen.

Selecting OK restarts the camera and switches the baud rate. There is no video output during the restart.

Setting to Default

For returning all settings except video out and communication system to factory default. The following items will not return to default setting.

- Video output mode
- HDMI Color Space
- Camera ID
- RS-485 ID
- RS-485 Baud.

RS-485 Connection

Connect according to the diagram below to control via RS-485.

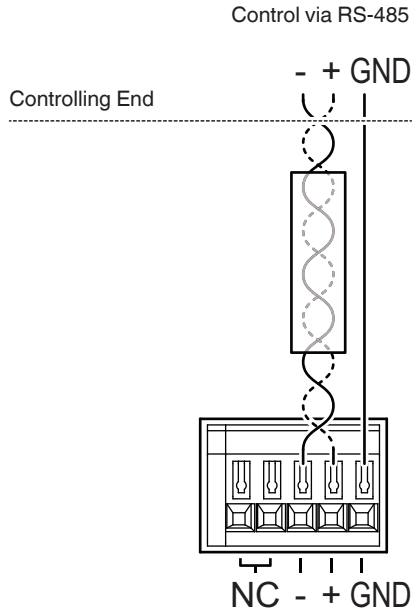

Terminal Block on the Back of SSZ-9700

Device Setting (2/2) Menu

Dev. Setting (Page 2/2)		
Privacy Mask	On	↵
MenuDispTime	60 Sec	
Message Disp	Off	
RETURN	EXIT	NEXT

Privacy Mask

Up to 8 different Privacy Masks can be individually set up.
Selecting Privacy Mask switches the screen to a Privacy Mask display.

Privacy Mask		
Mask1	On	↵
Mask2	Off	
Mask3	Off	
Mask4	Off	
Mask5	Off	
Mask6	Off	
Mask7	Off	
Mask8	Off	
Paint	Gray	
RETURN	EXIT	

You can set Mask 1 to 8 to On or Off individually.
The mask color can be selected from Gray, White and Black.
The screen for setting the position and size of the mask appears when a Mask is selected and set to On using the Arrow button.

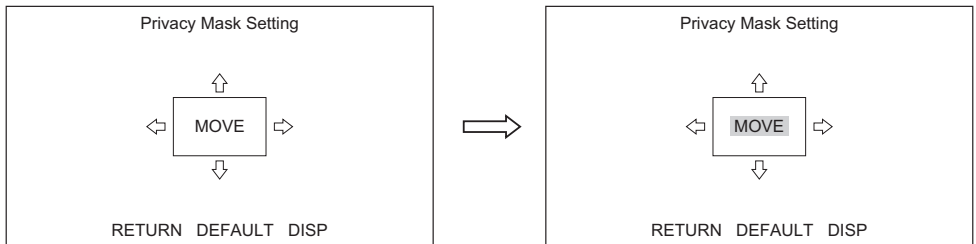

Move the cursor to the position where you want to change and press the Arrow button. The cursor changes from flashing to dark highlight flashing. In the above figure, you can shift the position (MOVE) using the Arrow buttons.

And the size (arrows ⇐⇒) can be changed using the Arrow buttons.

To change the position you want to change, press the Arrow button. The cursor resumes to normal flashing from dark highlight flashing and the position can be shift using the Arrow buttons.

Menu Display Time

Allows you to set the duration to display the OSD menu.

- 10 s / 60 s / Always

Message Disp

For selecting whether to display or hide the following messages on the screen.

On

The status display of Zoom, Focus and One-Push AF.

Off

The status message is not displayed.

Information: Version

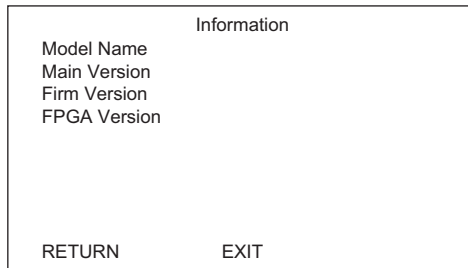

Information like Model Name, Serial No, etc.

Model Name

Model name

Main Version

Main program version

Firm Version

Firm program version

FPGA Version

FPGA program version

Restrictions on Menu Setting

Some items cannot be set (item not displayed) under certain settings.
Refer to here for items that are not displayed.

○: Can be set, x: Cannot be set (item not displayed), *: Exception (item is displayed but the setting value is changed because the setting items cannot be used simultaneously)

Setting Condition			HDR = On	Auto Knee = On	Auto B.str = On	Fog = Low, Mid, High Opt.DefogL, M, H	
Menu	Item	Setting value etc.					
Picture	HDR		-	○	○	○ (* Priority to HDR. When HDR = On, setting value for Fog changes)	
	Auto Knee		○	-	○	* (Changes to Off)	
	Auto B.str		○	○	-	* (Changes to Off)	
	Black Level		x	○	x	○	
	Gamma		x	x	x	x	
	Fog	Off		○	○	○	-
		Opt.Defog					
Low, Mid, High			x	* (Changes to Off)	* (Changes to Off)	-	
	Opt.DefogL, M, H		x	* (Changes to Opt.Defog)	* (Changes to Opt.Defog)	-	

Setting Condition			HDR = On	
Menu	Item	Setting value etc.		
ALC	ALC Mode		○	
	ALC Limits	Shutter Limit	x	
		Others	○	
	Shutter		1/30 to 1/4000 (59.94Hz system) 1/25 to 1/4000 (50Hz system)	
	BLC Mode		x	
	Detailed	Flickerless		x

Setting Condition			ALC Mode = Gain Prio. Gain=0.0 to 5.7 dB
Menu	Item	Setting value etc.	
ALC	ALC Limits	Shutter Limit (L)	1/60 to 1/4000 (59.94Hz system) 1/50 to 1/4000 (50Hz system)

Menu Structure

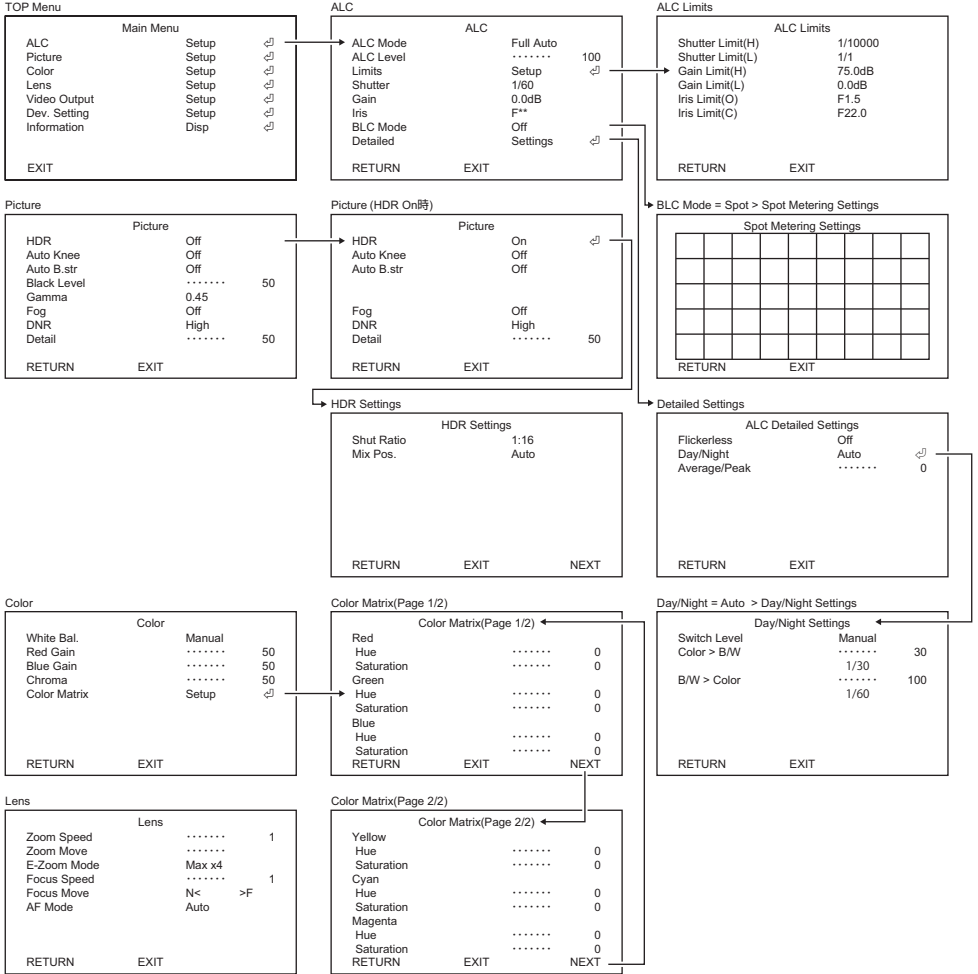

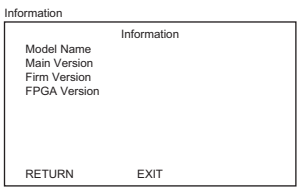
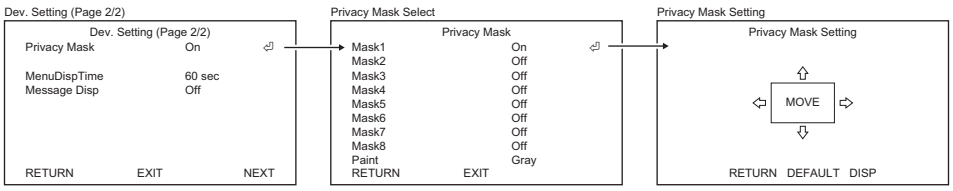
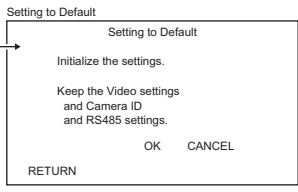
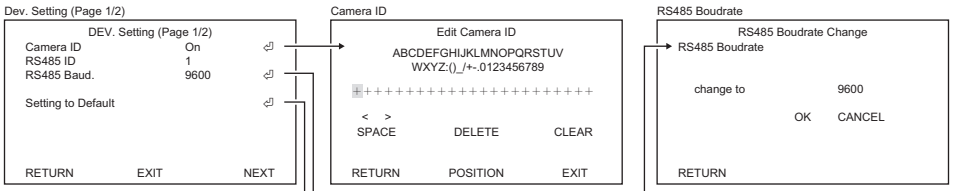
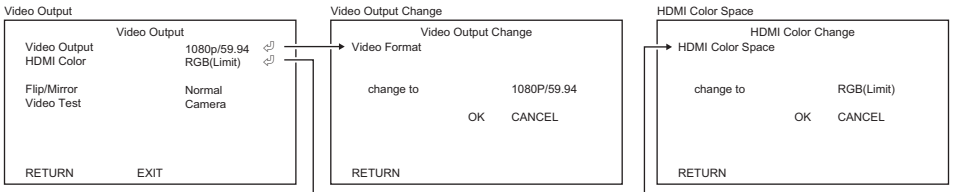

Specifications

Lens Unit

Zoom Ratio	35x (when digital zoom is On: up to 350x)
Focal Length	6.5 mm to 230 mm
Angle of View (HxV) [16:9]	Wide: 60.4° x 35.9° Tele: 2.0° x 1.2°
Aperture Range	F1.5 to F22
Optical Filter	IR cut filter/Dummy filter/Defog filter
Zoom/Focus/Aperture Control	Stepping motor
Focus Range	5 m to ∞
Focus System	Auto Focus, One Push Auto Focus, Manual

Camera Unit

Image Sensor	Single Panel CMOS/ RGB Bayer Array	
Total Pixels	Approximately 2,270,000 pixels 2016 (H) × 1128 (V)	
Effective Pixels	Approximately 2,120,000 pixels 1936 (H) × 1096 (V)	
Pixel Size	4.1 Mm (H) × 4.1 μm (V)	
Optical Size	1/1.8 inch	
Sensor Frame Rate	59.94 fps/50 fps (1/2 fps when in HDR mode)	
Scanning System	Progressive	
Minimum Illumination	0.004 lx (F1.5 1/30 s, 50 IRE, +78 dB)	
Horizontal Resolution	900 TV lines or more	
SN Ratio	50 dB or above ($\gamma = 1$, Contour Correction OFF, DNR OFF)	
Image Quality Adjustment	Exposure Mode	Full Auto / Shut. Prio. / Gain Prio. / Iris Prio. / Manual
	Gain	Manual: 0 dB to 78 dB (0.3 dB step)
	Electronic Shutter	1/1, 1/2, 1/4, 1/8, 1/15, 1/30, 1/60, 1/100, 1/125, 1/250, 1/500, 1/1000, 1/2000, 1/4000, 1/10000 s [59.94Hz system] 1/1, 1/2, 1/3, 1/6, 1/12, 1/25, 1/50, 1/100, 1/125, 1/250, 1/500, 1/1000, 1/2000, 1/4000, 1/10000 s [50Hz system]
	Iris	F1.5 to F22
	ALC Adjustment	Level adjustment/ Limits adjustment
	Backlight Correction	On/ Off/ Spot
	Gamma Correction	0.35 to 0.55 (0.01 step) / 1.0
	DNR	Off / Low / High

Image Quality Adjustment	White Balance	ATW1 / ATW2 / AWC / Manual / Low Temp. / Hi Temp.
	HDR MODE	Off / HDR / Auto Knee / Auto Black Stretch
	Defog	Optical Defog / Digital Defog (3 levels each)
	Color Matrix	R/G/B/Ye/Cy/Mg 6 axis adjustment
	Others	Detail / Chroma / Black Level
Digital Zoom	1 to 10x (in tandem with optical zoom, Off / Max x4 / Max x10)	
Image Reversal	Mirror/Flip/Mirror Flip	
Privacy Mask	8 masks Gray/White/Black	
Test Pattern	Color Bar, Gray Scale, built-in Cross Line	
Operation	Via OSD screen	

Interface

Image Output Terminal	3G-SDI (BNC) x1 HDMI (Type A) x1	
Serial Port	RS-485 (Carina original command)	
Video Output	3G-SDI, HDMI	1080P/59.94 (LEVEL A), 1080i/59.94, 1080p/29.97, 1080p/50.00 (LEVEL A), 1080i/50.00, 1080p/25.00

General

Power Supply	DC 12 V \pm 10 % (Ripple 50 mVp-p or less)
Power Consumption	11 W
Operational Temperature/ Humidity Range	-10 to 50°C / 10 to 90 %
Storage Temperature/ Humidity Range	-10 to 60°C / 10 to 90 %
Dimension	95.0 (W) x 95.0 (H) x 165.0 (D) mm excluding protrusions
Weight	1.5 kg

- The specifications and/or appearance of the product are subject to change without prior notice.

Dimensions

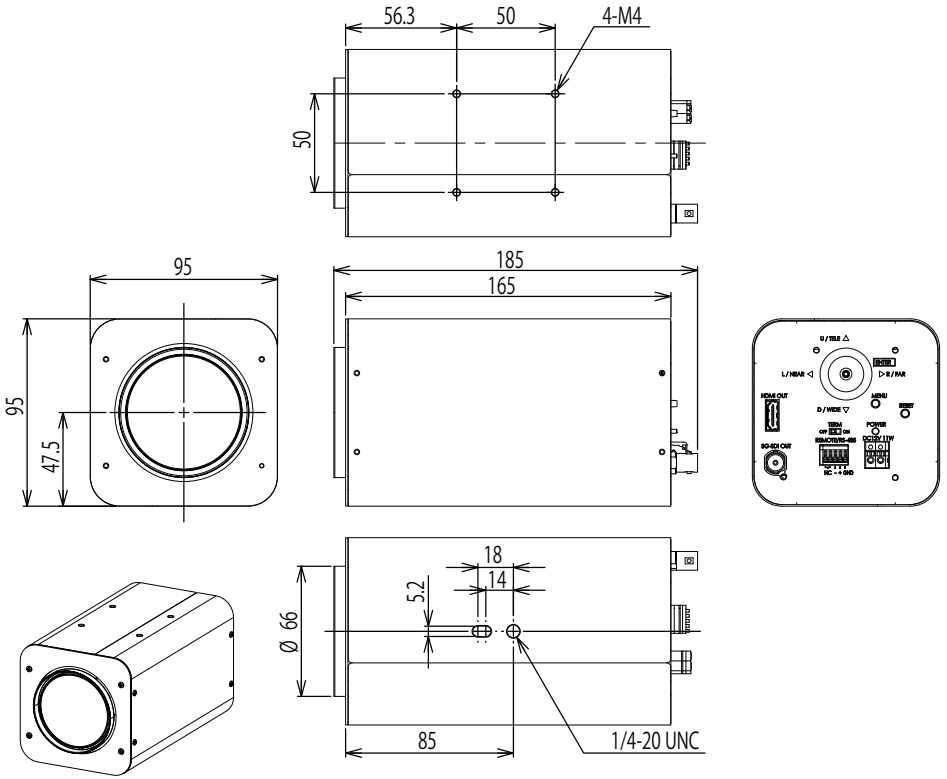

Recycling Information

This product, when disposed of, is supposed to be collected and recycled according to your country's legislation to reduce environmental burden. When you dispose of this product, please contact a distributor or an affiliate in your country.

Memo

Memo

Warranty Policy

1. The warranty covers hardware products manufactured and sold by us.
If this product breaks down during the warranty period under normal usage, we will repair it at no charge.
2. In the following cases, repairs will be on a chargeable basis even within the warranty period.
 - ① Damage caused by dropping the product when the customer carries it around or due to an accident during transporting.
 - ② Any repair or modification not by us or our authorized business representatives.
 - ③ Problems caused by the software components of this product, virus infection, forgetting your configured password, etc.
 - ④ Damage caused by unavoidable occurrences of fire, storm and flood, earthquake, lightning strike and other natural disasters as well as pollution, smoke hazard, gas, abnormal voltage, etc.
 - ⑤ Damage caused by devices connected to this product.
 - ⑥ Replacement of consumables.
 - ⑦ Malfunction or damage caused by misuse and not following the safety precautions and requirements stated in the instruction manual.
 - ⑧ Malfunction or damage caused by using the product outside the operating conditions stated in the instruction manual.
3. Defective parts removed from this product for repair purpose will be returned to the manufacturer to recycle instead of returning to the customer.
4. Replacement unit will not be provided while the product is under repair.
5. This warranty extends only to the original purchaser and is not transferable to anyone who subsequently purchase or obtain ownership of the product from the original purchaser.

Disclaimer

1. We are not liable for malfunction or defect caused by fire, storm and flood, earthquake, lightning strike and other natural disasters, acts by third party, other accidents, intentional or negligent conducts by the customer or a third party.
2. We are not liable for any secondary damages (business interruption and loss of business profit, loss of contents stored in the storage device or storage medium, damage, etc.) caused by the use of this product or the occurrence of defects.
3. We do not bear the repair costs (except for our product) incurred on other devices due to malfunction or damage arising from installing to this product.
4. We are not liable for any damages caused by not observing the contents in the instruction manual.

Warning for Radio interference

For U.S.A., Canada Only

FCC Supplier's Declaration of Conformity

We, the Responsible Party

EIZO Inc.
5710 Warland Drive, Cypress, CA 90630
Phone: (562) 431-5011

declare that the product

Trade name: Carina System Co., Ltd.
Model: SSZ-9700

is in conformity with Part 15 of the FCC Rules. Operation of this product is subject to the following two conditions: (1) this device may not cause harmful interference, and (2) this device must accept any interference received, including interference that may cause undesired operation.

WARNING!

This equipment has been tested and found to comply with the limits for a Class A digital device, pursuant to Part 15 of the FCC Rules. These limits are designed to provide reasonable protection against harmful interference when the equipment is operated in a commercial environment.

This equipment generates, uses, and can radiate radio frequency energy and if not installed and used in accordance with the instruction manual, may cause harmful interference to radio communications.

Operation of this equipment in a residential area is likely to cause harmful interference in which case the user will be required to correct the interference at his own expense.

Changes or modifications not expressly approved by the party responsible for compliance could void the user's authority to operate the equipment.

Canadian Notice

This Class A information technology equipment complies with Canadian ICES-003.
Cet équipement informatique de classe A est conforme à la norme NMB-003 du Canada.

For Europe Only

Warning

Operation of this equipment in a residential environment could cause radio interference.

Warnung

Der Betrieb dieses Geräts in einer Wohnumgebung konnte Funkstörungen verursachen.

Avertissement

L'utilisation de cet équipement dans une zone résidentielle pourrait provoquer des interférences radio.

For consultation of the product or requests for repair, please contact the dealer / retailer.

Dealer/Retailer
Address:
Phone: () -

SSZ-9700 Instruction Manual

Issue Date: February 2st , 2022

Carina System Co., Ltd.

<http://www.carinasystem.co.jp/en>

EU IMPOTER :

EIZO Europe GmbH

Belgrader Straße 2, 41069 Mönchengladbach, Germany

UK IMPORTER :

EIZO Limited

1 Queens Square, Ascot Business Park, Lyndhurst Road,
Ascot, Berkshire, SL5 9FE, UK

©2021 Carina System Co., Ltd.

Doc# MCM1081801-021