

User's Manual

用户手册

English

中文

DuraVision®

FDX1001

FDV1001

FDX1201

Color LCD Monitor
彩色液晶显示器

Important

Please read this User's Manual carefully to familiarize yourself with safe and effective usage. Please retain this manual for future reference.

重要事项

请仔细阅读用户手册，掌握如何安全、有效地使用本产品。请保留本手册，以备日后参考。



User's Manual

English

DuraVision[®]

FDX1001





FDV1001

FDX1201

Color LCD Monitor

SAFETY SYMBOLS

This manual and this product use the safety symbols below. They denote critical information. Please read them carefully.

 WARNING	
Failure to abide by the information in a WARNING may result in serious injury and can be life threatening.	
 CAUTION	
Failure to abide by the information in a CAUTION may result in moderate injury and/or property or product damage.	
	Indicates an attention to be required.
	Indicates a prohibited action.

Using the special functions, such as screen size change (ex. changing the horizontal and vertical ratio of images input) for commercial purposes or for the purpose of showing in public may violate copyright laws.

This product has been adjusted specifically for use in the region to which it was originally shipped. If operated outside this region, the product may not perform as stated in the specifications.

No part of this manual may be reproduced, stored in a retrieval system, or transmitted, in any form or by any means, electronic, mechanical, or otherwise, without the prior written permission of EIZO Corporation.

EIZO Corporation is under no obligation to hold any submitted material or information confidential unless prior arrangements are made pursuant to EIZO Corporation's receipt of said information.

Although every effort has been made to ensure that this manual provides up-to-date information, please note that EIZO monitor specifications are subject to change without notice.

Apple, ColorSync, eMac, iBook, iMac, iPad, Mac, MacBook, Macintosh, Mac OS, PowerBook, and QuickTime are registered trademarks of Apple Inc.

Windows, Windows Media, Windows Vista, SQL Server, and Xbox 360 are registered trademarks of Microsoft Corporation in the United States and other countries.

VESA is a registered trademark of Video Electronics Standards Association.

NEC is a registered trademark of NEC Corporation.

PC-9801 and PC-9821 are trademarks of NEC Corporation.

EIZO, the EIZO Logo, ColorEdge, DuraVision, FlexScan, FORIS, RadiCS, RadiForce, RadiNET, Raptor, and ScreenManager are registered trademarks of EIZO Corporation in Japan and other countries.

All other company and product names are trademarks or registered trademarks of their respective owners.

PRECAUTIONS

IMPORTANT

- This product is intended to be used with an industrial device designed to build industrial systems.
 - Transportation systems (Ship, aircraft, train, automobile, etc.)
 - Safety devices (Disaster prevention system, security control system, etc.)
 - Equipment with direct effect on human life (Life support systems, Medical equipment or devices used in the operating room, etc.)
 - Nuclear energy control devices (Nuclear energy control systems, security control systems of nuclear facilities, etc.)
 - Main line devices (Operation control for transportation, control systems specific to aircrafts, etc.)
- To ensure personal safety and proper maintenance, please read this section.

WARNING

This product is intended to be housed in an enclosure. Do not use the bare monitor separately.

Attempting to use a malfunctioning unit may result in electric shock, or equipment damage.



If the unit begins to emit smoke, smells like something is burning, or makes strange noises, disconnect all power connections immediately and contact your dealer for advice.

Attempting to use a malfunctioning unit may result in fire, electric shock, or equipment damage.

Do not open the cabinet or modify the unit.

Opening the cabinet or modifying the unit may result in fire, electric shock, or burn.



Refer all servicing to qualified service personnel.

Do not attempt to service this product yourself as opening or removing covers may result in fire, electric shock, or equipment damage.

Keep small objects or liquids away from the unit.

Small objects accidentally falling through the ventilation slots into the cabinet or spillage into the cabinet may result in fire, electric shock, or equipment damage. If an object or liquid falls/spills into the cabinet, unplug the unit immediately. Have the unit checked by a qualified service engineer before using it again.



Use the unit in an appropriate location.

Not doing so may result in fire, electric shock, or equipment damage.

- Do not place outdoors.
- Do not place in a transportation system (ship, aircraft, train, automobile, etc.) where it may be affected by strong vibration or shock.
- Do not place in a dusty or humid environment.
- Do not place in a location where water is splashed on the screen (bathroom, kitchen, etc.).
- Do not place in a location where the steam comes directly on the screen.
- Do not place near heat generating devices or a humidifier.
- Do not place in a location where the product is subject to direct sunlight.
- Do not place in an inflammable gas environment.



WARNING

Use the enclosed AC adapter.

The enclosed AC adapter is for use with this product only. Do not use the AC adapter with other equipment. Connecting to power sources that do not match the power ratings of the AC adapter may result in fire or electric shock.

Make sure the power cord meets the following requirements.

This product does not include a power cord. Please provide separately a power cord which meets the requirements. (For more information, please contact your dealer.)

- The power cord is compatible with the standards of the country and region in which this product is to be used.
- The power cord has a rated value of at least 2.5A.

Power supply: 100-240Vac 50/60Hz

To disconnect the power cord, grasp the plug firmly and pull.

Tugging on the cord may damage and result in fire or electric shock.



Use the correct voltage.

- The unit is designed for use with a specific voltage only. Connection to another voltage than specified in this User's Manual may cause fire, electric shock, or equipment damage.

Power supply: 100-240Vac 50/60Hz

- Do not overload your power circuit, as this may result in fire or electric shock.
-

Handle the power cord and AC adapter with care.

Do not place heavy objects on, pull or tie the power cord or the AC adapter. Use of a damaged cord or AC adapter may result in fire or electric shock.



Never touch the plug, AC adapter or power cord during a thunderstorm.

Touching them may result in electric shock.



Do not touch a damaged LCD panel directly with bare hands.

The liquid crystal that may leak from the panel is poisonous if it enters the eyes or mouth. If any part of the skin or body comes in direct contact with the panel, please wash thoroughly. If some physical symptoms result, please consult your doctor.



CAUTION

Handle with care when carrying the unit.

Disconnect the power cord and cables when moving the unit. Moving the unit with the cord attached is dangerous. It may result in injury.

Do not install the unit in a closed space.

If the interior becomes hot, it may result in fire, electric shock or damage.



Do not touch the power plug or AC adapter with wet hands.

Doing so may result in electrical shock.



Use an easily accessible power outlet.

This will ensure that you can disconnect the power quickly in case of a problem.

Mind that the AC adapter becomes hot during use.

- Do not cover or place anything on top of the AC adapter. Do not place the AC adapter on top of things that trap heat. Keep the AC adapter away from heat sources and direct sunlight. Not doing so may result in fire.
- Do not touch with bare hands. Doing so may result in burns.

The ambient temperature for using the AC adapter should not exceed 40 °C (104 °F).

Do not suspend the AC adapter in midair.

Using it while suspended in midair may result in fire or electric shock.



Periodically clean the area around the plug.

Dust, water, or oil on the plug may result in fire.

Unplug the unit before cleaning it.

Cleaning the unit while it is plugged into a power outlet may result in electric shock.

If you plan to leave the unit unused for an extended period, disconnect the power cord from the wall socket after turning off the power for safety and power conservation.

Notice for this monitor

This product has been adjusted specifically for use in the region to which it was originally shipped. If the product is used outside the region, it may not operate as specified in the specifications.

This product may not be covered by warranty for uses other than those described in this manual.

Only use optional products manufactured or specified by us with this product.

As it takes about 30 minutes for the performance of electrical parts to stabilize, adjust the monitor 30 minutes or more after the monitor power has been turned on.

Monitors should be set to a lower brightness to reduce changes in luminosity caused by long-term use and maintain a stable display.

When the screen image is changed after displaying the same image for extended periods of time, an afterimage may appear. Use the screen saver or power save function to avoid displaying the same image for extended periods of time.

Periodic cleaning is recommended to keep the monitor looking new and to prolong its operation lifetime.
(Refer to “Cleaning” on the next page.)

The LCD panel is manufactured using high-precision technology. Although, missing pixels or lit pixels may appear on the LCD panel, this is not a malfunction. Percentage of effective dots: 99.99% or higher.

The backlight of the LCD panel has a fixed lifetime. When the screen becomes dark or begins to flicker, please contact your local EIZO representative.

Do not press on the panel or edge of the frame strongly, as this may result in display malfunctions, such as interference patterns, etc. If pressure is continually applied to the panel, it may deteriorate or damage your panel. (If the pressure marks remain on the panel, leave the monitor with a black or white screen. The symptom may disappear.)

Do not scratch or press on the panel with any sharp objects, as this may result in damage to the panel. Do not attempt to brush with tissues as this may scratch the panel.

When the monitor is cold and brought into a room or the room temperature goes up quickly, dew condensation may occur on the interior and exterior surfaces of the monitor. In that case, do not turn the monitor on. Instead wait until the dew condensation disappears, otherwise it may cause some damage to the monitor.

Cleaning

ATTENTION

- Chemicals such as alcohol and antiseptic solution may cause gloss variation, tarnishing, and fading of the panel, and also quality deterioration of the image.
 - Never use any thinner, benzene, wax, and abrasive cleaner, which may damage the panel.
-

NOTE

- The optional ScreenCleaner is recommended for cleaning the panel surface.
-

If necessary, the stains on the panel surface can be removed by moistening part of a soft cloth with water.

To use the monitor comfortably

- An excessively dark or bright screen may affect your eyes. Adjust the brightness of the monitor according to the environmental conditions.
- Staring at the monitor for a long time tires your eyes. Take a 10-minute rest every hour.

CONTENTS

Cover	1
⚠ PRECAUTIONS.....	3
Notice for this monitor	6
CONTENTS	8
Chapter 1 Introduction	9
1-1. Features	9
1-2. Package Contents	9
Chapter 2 Assembly	10
Chapter 3 Settings and Adjustments	13
3-1. Buttons	13
3-2. Basic Operation and Functions	14
Chapter 4 Troubleshooting	17
Chapter 5 Reference.....	18
5-1. Specifications	18
5-2. Glossary	21
5-3. Preset Timing.....	22
LIMITED WARRANTY	23

Chapter 1 Introduction

Thank you very much for choosing an EIZO color LCD monitor.

1-1. Features

- FDX1001 / FDV1001: 10.4-inch screen, FDX1201: 12.1-inch screen
- Resolution
 - FDX1001 / FDX1201: XGA (1024 × 768) display compliant
 - FDV1001: VGA (640 × 480) display compliant
- Maximum brightness
 - FDX1001: 600 cd/m², FDV1001: 450 cd/m², FDX1201: 1000 cd/m²
- LED backlight LCD panel
 - The LED backlight provides better power efficiency and reduced power consumption compared to existing fluorescent backlight LCD panels.
 - No mercury, a hazardous substance, is used.
- Analog signal support
 - PC signal: D-Sub mini 15 pin connector × 1
 - FDX1001 / FDX1201:
 - Horizontal scanning frequency 24 kHz - 50 kHz, Vertical scanning frequency 55 Hz - 75 Hz
 - FDV1001:
 - Horizontal scanning frequency 24 kHz - 32 kHz, Vertical scanning frequency 56 Hz - 70.5 Hz
 - Video signal: S-Video/ Video input connector × 1
 - Applicable Format NTSC, PAL, SECAM
- Crosshair display function
 - Displays lines (Fine, Circle or Broken Line) as a reference for the position of the image displayed on the monitor. (page 16)
- Video aspect function
 - Alters the display range of the input image (overscan). (page 16)

1-2. Package Contents

Please contact your local dealer for assistance if any of the listed items are missing or damaged.

NOTE

- Please retain the packing materials for future transport of the monitor.
-

- LCD Monitor
- AC Adapter
- Cable Tie
- Handle: 2 pcs.
- Handle mounting screw (M5 × 10 mm): 4 pcs.
- User's Manual (Limited Warranty included)

ATTENTION

- This product does not include a power cord. Please provide separately a power cord which meets the usage requirements.
-

Chapter 2 Assembly

- Exterior view

FDX1001 / FDV1001

unit : mm (inch)

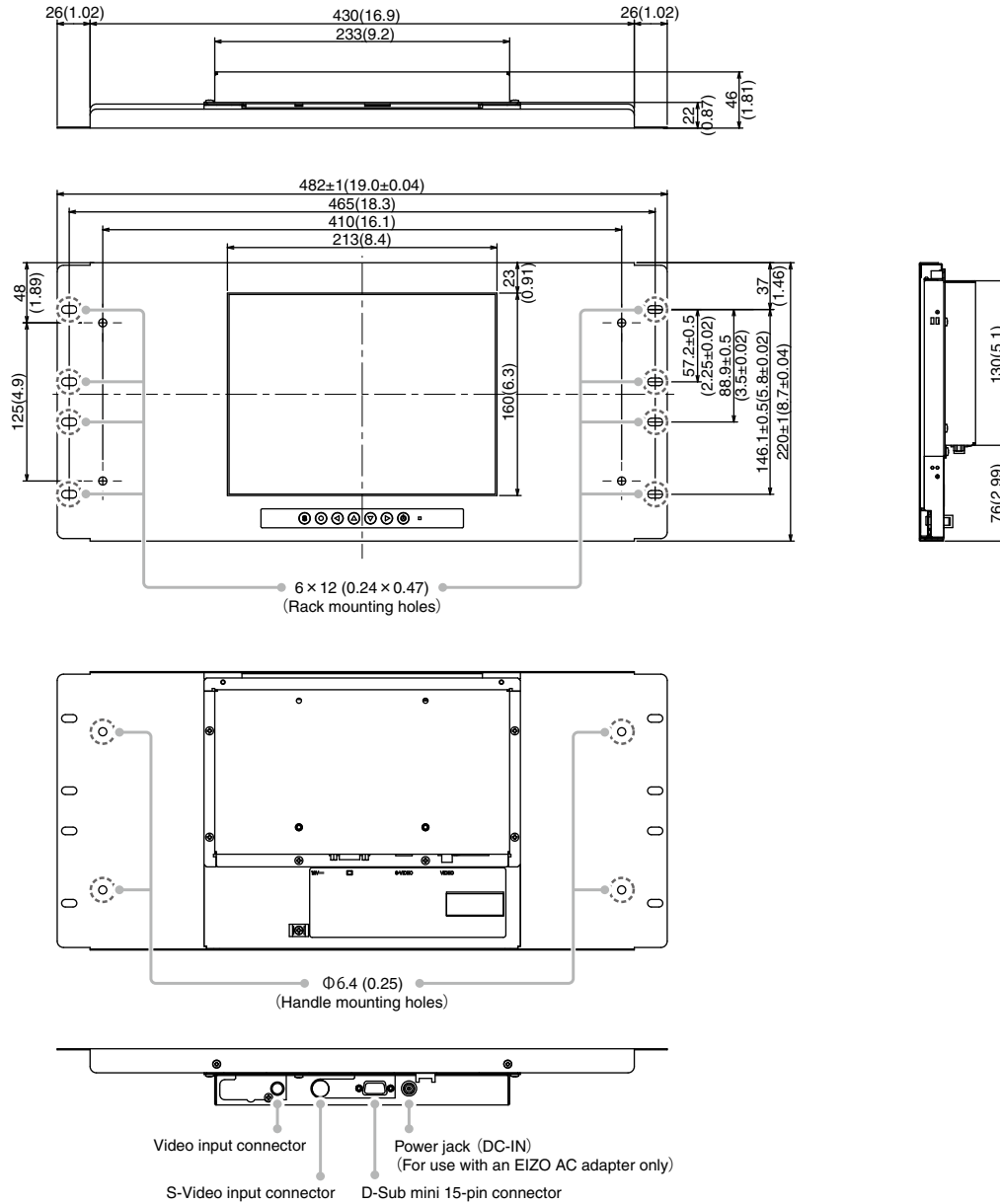

● **How to assemble**

ATTENTION

- This monitor can be attached to a 19-inch rack compliant with the EIA standards*1.

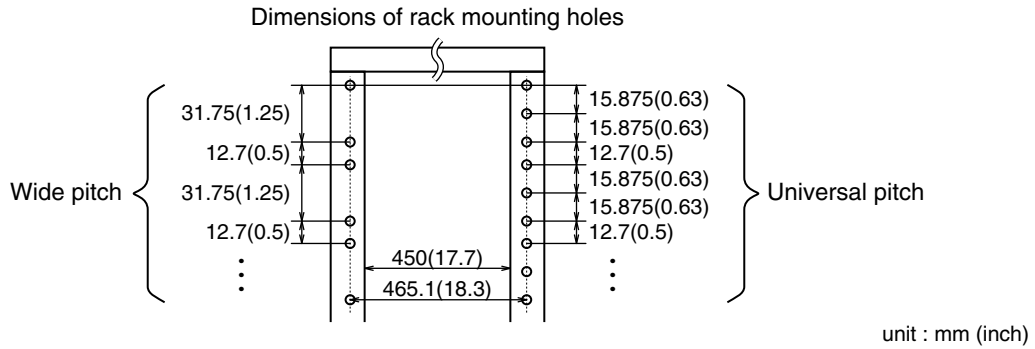

*1 EIA standards: Standards concerning sizes of racks and devices to be stored in the racks specified by Electric Industries Association (EIA)

1. Attach the two handles from the front and secure them from the rear using handle mounting screws (M5 × 10 mm: 4 pcs.).

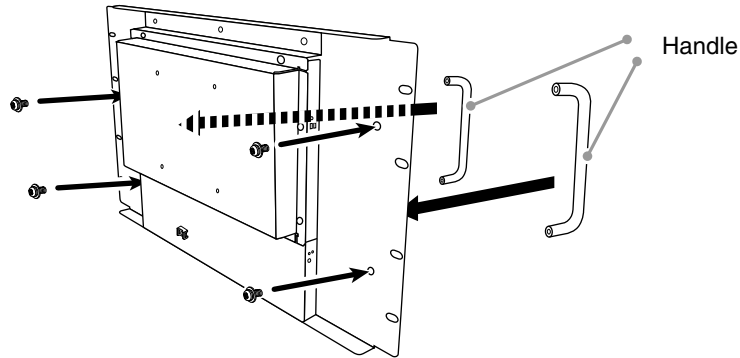

2. Attach the monitor to the rack while holding the handles on both sides and then secure the monitor using screws.

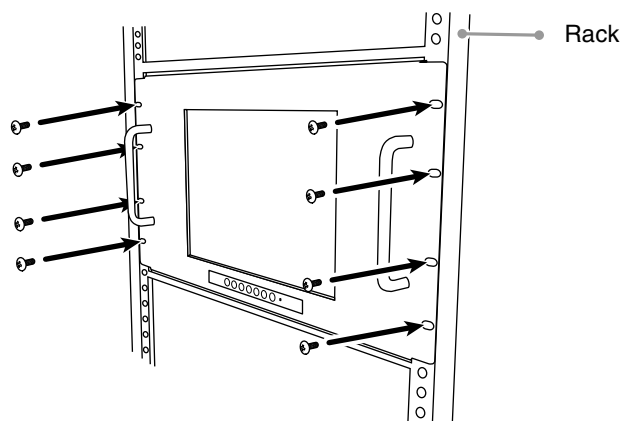

ATTENTION

- Screws for attaching the monitor to the rack are not included with this monitor. Prepare screws suitable for your rack.
- Refer to the User's Manual for the rack regarding the procedure to attach the monitor to the rack.
- Handles should be used to support the monitor during installation. Do not pull the handles on occasions other than installation.

Chapter 3 Settings and Adjustments

3-1. Buttons

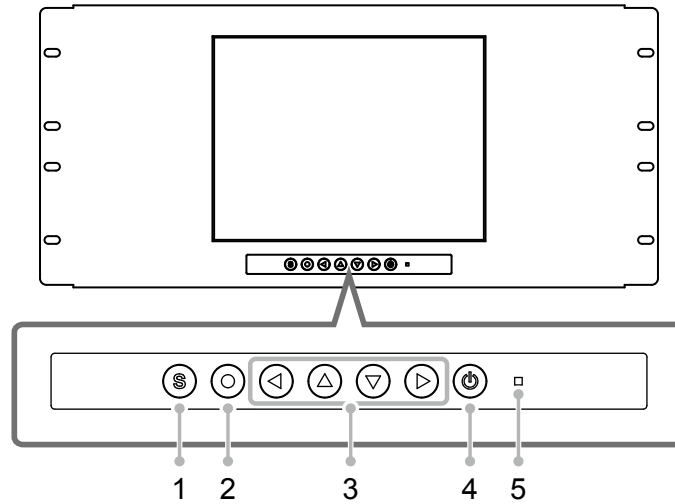

1	Ⓚ button	Switches the input signal.
2	Ⓞ button	Displays the Setting menu, fixes the setting or adjustment items on each menu, and saves the setting or adjustment results.
3	⏪ ⏩ ⏴ ⏵ button	<ul style="list-style-type: none"> Used to select the setting or adjustment items, or to increase or decrease the adjustment values on each menu. When the settings menu is not displayed, pressing ⏴ or ⏵ switches between displaying and not displaying the crosshair.
4	⏻ button	Turns the power on or off.
5	Power indicator	Indicates monitor's operation status. Blue: Operating Orange: Power off

3-2. Basic Operation and Functions

Basic operation of Setting menu

1 Displaying Setting Menu

Press **○**.

2 Setting/Adjusting

When a tab is selected (highlighted in yellow), press **◀** or **▶** to switch tabs.

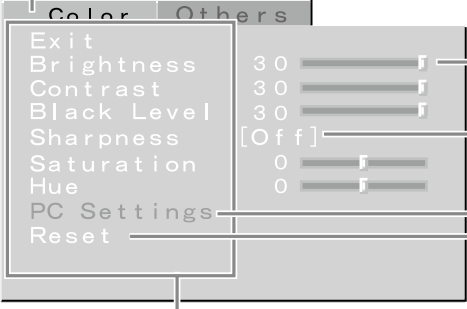

Pressing **○**, **◀** or **▶** on an item with a numerical value brings up an adjustment menu. (The Setting menu disappears when the adjustment menu is displayed.)



Adjust with **◀** or **▶**, and press **○**.

Pressing **○** on an item with a setting value brings up a selection menu.



Select a setting value with **▲** or **▼**, and press **○**.

Pressing **○** on an item without a setting value brings up a more detailed Setting menu.

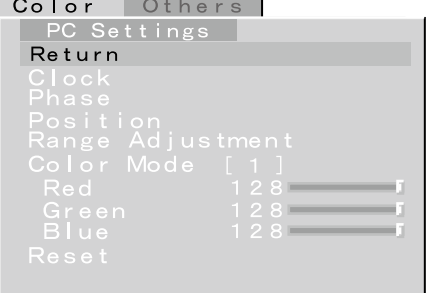

When done configuring the various items, choose [Return], and press **○** to return to the previous menu.

Pressing **○** on [Reset] will reset all the currently displayed settings to the default configuration.

1 Press **○**.



2 Select "Execute" in the confirmation dialog box, and press **○**.

3 Exiting

Choose [Exit] with **▲** or **▼**, and press **○**.

NOTE

- Keeping **○** pressed for 2 seconds will also exit the Setting menu.

Functions









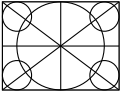
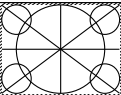
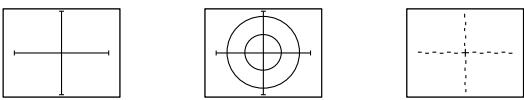

The settings adjustable in the Setting menu are as shown below. The availability of items depends on the input signal.

√ : Configurable — : Not configurable

Tab	Setting / adjustable item	Setting / adjustable value	PC	Video	Setting / adjustable content	
Color	Brightness	0 - 30	√	√	Adjusts the brightness of the backlight.	
	Contrast	0 - 30	√	√	Adjusts the contrast.	
	Black Level	0 - 30	√	√	Adjusts the image brightness.	
	Sharpness	Off/Low/High	—	√	Adjusts the image outlines.	
	Saturation	-30 - +30	—	√	Adjusts the saturation.	
	Hue	-30 - +30	—	√	Adjusts the hue.	
	PC Settings* ¹	Clock		√	—	Adjust this when vertical bars appear.
		Phase		√	—	Adjust this when the screen appears to flicker or blur.
		Position		√	—	Adjust this when the display positioning is misaligned.
		Range Adjustment		√	—	Provides automatic adjustment when you want every color gradients displayed.
		Color Mode* ²	1/2/3	√	—	Select Color Mode (1/2/3) to adjust the colors of red, green and blue in several modes.
		Red/ Green/ Blue	0 - 128	√	—	
	Reset			√	—	Resets the state adjusted with [PC Settings] to the factory default.
Reset			√	√	Resets the state adjusted with the [Color] tab to the factory default (excluding [PC Settings]).	

*¹ This setting becomes available when a PC is connected to the monitor. Please adjust with a PC when display and color adjustments are required.

*² Perform [Range Adjustment] before adjusting Color Mode.

Tab	Setting / adjustable item	Setting / adjustable value	PC	Video	Setting / adjustable content	
Others	Video Aspect	Normal/100%	—	√	<p>Configures the display range of the input image (overscan).</p> <hr/> <p>“Normal” : Displays the input image with the outmost parts slightly cut off. * This is how display devices normally display images.</p>  <hr/> <p>“100%” : Displays most of the input image. * Because a part of the image which normally gets cut off is displayed as well, noise may be visible around the outmost parts, depending on the input signal.</p> 	
	Power Save	Disable/Enable	√	√	Automatically turns off the power supply if no video signal has been received for 15 minutes during PC or video viewing.	
	Reverse	Off/On	√	√	Displays the image upside down (180 degree rotation).	
	Crosshair	Off/Fine/Circle/ Broken Line	√	√	<p>Displays a crosshair as a reference for the position of the image.</p> <hr/> <p>“Fine” “Circle” “Broken Line”</p>  <hr/> <p>(When the settings menu is not displayed, pressing  or  switches between displaying and not displaying the crosshair.)</p>	
		Color	When “Fine” is selected: Black/White/Red/ Green When “Circle” or “Broken Line” is selected: Black/White	√	√	Configures the color of the crosshair.
		Width	Narrow/Wide	√	√	Configures the thickness of the crosshair's lines.
		Beep	Off/On	√	√	<p>Sets button press sounds and connection error sounds to on or off.</p> <hr/> <ul style="list-style-type: none"> • Short beep : - When ,  or  is pressed. - When an item is selected with . - When a maximum or minimum value is set with  or . <hr/> <ul style="list-style-type: none"> • Long beep : When registration is performed with . <hr/> <ul style="list-style-type: none"> • 2 short beeps : When the Setting menu is displayed and  is pressed. <hr/> <ul style="list-style-type: none"> • 4 short beeps : - When there is no input signal. - When a frequency out of the specified range is received.
		Language	日本語 /English	√	√	Configures the displayed Setting menu and message language.
		Information		√	√	Reviews the input signals, usage time and model name.



Chapter 4 Troubleshooting

If a problem still remains after applying the suggested remedies, contact your local dealer.

Common

Problems	Possible cause and remedy
No picture <ul style="list-style-type: none"> Power indicator does not light. 	<ul style="list-style-type: none"> Check whether the power cord is connected correctly. If the problem persists, turn off the power, and then turn it on again a few minutes later.
<ul style="list-style-type: none"> Power indicator lights orange. 	<ul style="list-style-type: none"> Press .
<ul style="list-style-type: none"> Power indicator lights blue. 	<ul style="list-style-type: none"> Check whether the power of the connected device is turned on. Switch the input signal. Set each adjusting value in [Brightness] and [Contrast] to higher level. (see page 15)
The screen is too bright or too dark.	<ul style="list-style-type: none"> Adjust using [Brightness] or [Contrast]. (The LCD monitor backlight has a fixed life span. When the screen becomes dark or begins to flicker, contact your local dealer.) (see page 15)
Green/red/blue/white dots or defective dots remain on the screen.	<ul style="list-style-type: none"> This is due to LCD panel characteristics and is not a failure.
Interference patterns or pressure marks remain on the screen.	<ul style="list-style-type: none"> Leave the monitor with a white or black screen. The symptom may disappear.
Afterimages appear.	<ul style="list-style-type: none"> Afterimages are particular to LCD monitors. Avoid displaying the same image for a long time. When displaying the same image for extended periods of time, please set up the screen saver and/or make use of the power saving function.

When displaying on a PC screen

Problems	Possible cause and remedy
The message below appears. <ul style="list-style-type: none"> This message appears when no signal is input. 	<ul style="list-style-type: none"> This message appears when the signal is not input correctly even when the monitor functions properly. The message shown left may appear, because some PCs do not output the signal soon after power-on. Check whether the PC is turned on. Check whether the signal cable is connected properly.
<ul style="list-style-type: none"> The message shows that the input signal is out of the specified frequency range. 	<ul style="list-style-type: none"> Check whether the signal setting of your PC matches the resolution and the vertical frequency settings for the monitor. (see page 18, 19, 20) (Current input signal can be checked in [Information].) Reboot the PC. Select an appropriate display mode using the graphics board's utility. Refer to the manual of the graphics board for details.
Display position is incorrect.	<ul style="list-style-type: none"> Adjust image position using [Position]. (see page 15)
Vertical bars appear on the screen or a part of the image is flickering.	<ul style="list-style-type: none"> Adjust using [Clock]. (see page 15)
Whole screen is flickering or blurring.	<ul style="list-style-type: none"> Adjust using [Phase]. (see page 15)
Characters are blurred.	<ul style="list-style-type: none"> This may occur when a non-complying high-resolution signal is input. Check the PC settings and change the resolution which complies with the monitor.

Chapter 5 Reference

5-1. Specifications

FDX1001

LCD Panel	Size	10.4-inch (260 mm) TFT color LCD
	Surface treatment	Anti-glare hard coating
	Surface hardness	3H
	Viewing angle	Horizontal 160°, Vertical 130° (CR : 10 or more)
	Dot Pitch	0.2055 mm
Display Area (H × V)		210.4 mm × 157.8 mm
Resolution		1024 dots × 768 lines
Max. Display Color		Approx. 16.7 million colors
PC input	Horizontal Scan Frequency	24-50 kHz
	Vertical Scan Frequency	55-75 Hz (Non-interlace)
	Max. Dot Clock	65 MHz
	Input Signal Connector	D-Sub mini 15-pin × 1
	Input Signal (Sync)	Separate, TTL, positive / negative
	Input Signal (Video)	Analog, Positive (0.7Vp-p/75Ω)
	Max. Video Signal Memory	15 (preset : 13)
	Plug and Play	VESA DDC 2B/EDID structure 1.3
Video input	Applicable Format	NTSC, PAL, SECAM
	Input Signal Connector	S-Video DIN mini 4 pin/ Video Pin jack × 1
	Input Signal Level	S-Video DIN mini 4 pin : Y 1.0Vp-p/75Ω, C 0.28Vp-p/75Ω Video Pin jack : 1.0Vp-p/75Ω
Power Supply		AC adapter (AC) : 100-240VAC±10%, 50/60Hz, 0.3-0.2 A (Max.) Main unit (DC) : 12VDC±10%, 0.9 A
Power Consumption	Screen Display On	AC adapter (AC) : 13 W or less Main unit (DC) : 11 W or less
	Power Off	AC adapter (AC) : 1.3 W or less Main unit (DC) : 0.5 W or less
Dimensions (Width) × (Height) × (Depth)		482 mm (19.0 inch) × 220 mm (8.7 inch) × 46 mm (1.81 inch) (excluding the projection)
Mass		Approx. 3.2 kg (7.1 lbs.)
Environmental Conditions	Temperature	[Operating temperature] Main unit : 0 °C - 50 °C (32 °F - 122 °F) AC adapter : 0 °C - 40 °C (32 °F - 104 °F) [Storage temperature] -20 °C - 60 °C (-4 °F - 140 °F)
	Humidity	[Operating humidity] Main unit : 20% - 90% R.H. (wet bulb temperature ≤ 39 °C (102 °F), no condensation) AC adapter : 20% - 85% R.H. (no condensation) [Storage humidity] 10% - 90% R.H. (wet bulb temperature ≤ 39 °C (102 °F), no condensation)
	Pressure	[Operating] 700 hPa - 1060 hPa [Storage] 200 hPa - 1060 hPa

LCD Panel	Size	10.4-inch (260 mm) TFT color LCD
	Surface treatment	Anti-glare hard coating
	Surface hardness	3H
	Viewing angle	Horizontal 160°, Vertical 140° (CR : 10 or more)
	Dot Pitch	0.33 mm
Display Area (H × V)		211.2 mm × 158.4 mm
Resolution		640 dots × 480 lines
Max. Display Color		Approx. 16.2 million colors
PC input	Horizontal Scan Frequency	24-32 kHz
	Vertical Scan Frequency	56-70.5 Hz (Non-interlace)
	Max. Dot Clock	31 MHz
	Input Signal Connector	D-Sub mini 15-pin × 1
	Input Signal (Sync)	Separate, TTL, positive / negative
	Input Signal (Video)	Analog, Positive (0.7Vp-p/75Ω)
	Max. Video Signal Memory	10 (preset : 8)
	Plug and Play	VESA DDC 2B/EDID structure 1.3
Video input	Applicable Format	NTSC, PAL, SECAM
	Input Signal Connector	S-Video DIN mini 4 pin/ Video Pin jack × 1
	Input Signal Level	S-Video DIN mini 4 pin : Y 1.0Vp-p/75Ω, C 0.28Vp-p/75Ω Video Pin jack : 1.0Vp-p/75Ω
Power Supply		AC adapter (AC) : 100-240VAC±10%, 50/60Hz, 0.2-0.15 A (Max.) Main unit (DC) : 12VDC±10%, 0.7 A
Power Consumption	Screen Display On	AC adapter (AC) : 10 W or less Main unit (DC) : 9 W or less
	Power Off	AC adapter (AC) : 1.3 W or less Main unit (DC) : 0.5 W or less
Dimensions (Width) × (Height) × (Depth)		482 mm (19.0 inch) × 220 mm (8.7 inch) × 46 mm (1.81 inch) (excluding the projection)
Mass		Approx. 3.0 kg (6.6 lbs.)
Environmental Conditions	Temperature	[Operating temperature] Main unit : 0 °C - 50 °C (32 °F - 122 °F) AC adapter : 0 °C - 40 °C (32 °F - 104 °F) [Storage temperature] -20 °C - 60 °C (-4 °F - 140 °F)
	Humidity	[Operating humidity] Main unit : 20% - 90% R.H. (wet bulb temperature ≤ 39 °C (102 °F), no condensation) AC adapter : 20% - 85% R.H. (no condensation) [Storage humidity] 10% - 90% R.H. (wet bulb temperature ≤ 39 °C (102 °F), no condensation)
	Pressure	[Operating] 700 hPa - 1060 hPa [Storage] 200 hPa - 1060 hPa

FDX1201

LCD Panel	Size	12.1-inch (310 mm) TFT color LCD
	Surface treatment	Anti-glare
	Surface hardness	3H
	Viewing angle	Horizontal 160°, Vertical 140° (CR : 10 or more)
	Dot Pitch	0.240 mm
Display Area (H × V)		245.76 mm × 184.32 mm
Resolution		1024 dots × 768 lines
Max. Display Color		Approx. 16.7 million colors
PC input	Horizontal Scan Frequency	24-50 kHz
	Vertical Scan Frequency	55-75 Hz (Non-interlace)
	Max. Dot Clock	65 MHz
	Input Signal Connector	D-Sub mini 15-pin × 1
	Input Signal (Sync)	Separate, TTL, positive / negative
	Input Signal (Video)	Analog, Positive (0.7Vp-p/75Ω)
	Max. Video Signal Memory	15 (preset : 13)
	Plug and Play	VESA DDC 2B/EDID structure 1.3
Video input	Applicable Format	NTSC, PAL, SECAM
	Input Signal Connector	S-Video DIN mini 4 pin/ Video Pin jack × 1
	Input Signal Level	S-Video DIN mini 4 pin : Y 1.0Vp-p/75Ω, C 0.28Vp-p/75Ω Video Pin jack : 1.0Vp-p/75Ω
Power Supply		AC adapter (AC) : 100-240VAC±10%, 50/60Hz, 0.4-0.25 A (Max.) Main unit (DC) : 12VDC±10%, 1.4 A
Power Consumption	Screen Display On	AC adapter (AC) : 20 W or less Main unit (DC) : 17 W or less
	Power Off	AC adapter (AC) : 1.6 W or less Main unit (DC) : 0.8 W or less
Dimensions (Width) × (Height) × (Depth)		482 mm (19.0 inch) × 265 mm (10.4 inch) × 47 mm (1.85 inch) (excluding the projection)
Mass		Approx. 3.6 kg (7.9 lbs.)
Environmental Conditions	Temperature	[Operating temperature] Main unit : 0 °C - 50 °C (32 °F - 122 °F) AC adapter : 0 °C - 40 °C (32 °F - 104 °F) [Storage temperature] -20 °C - 60 °C (-4 °F - 140 °F)
	Humidity	[Operating humidity] Main unit : 20% - 90% R.H. (wet bulb temperature ≤ 39 °C (102 °F), no condensation) AC adapter : 20% - 85% R.H. (no condensation) [Storage humidity] 10% - 90% R.H. (wet bulb temperature ≤ 39 °C (102 °F), no condensation)
	Pressure	[Operating] 700 hPa - 1060 hPa [Storage] 200 hPa - 1060 hPa

Connector Pin Assignment

- D-Sub mini 15-pin connector

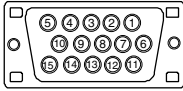

Pin No.	Signal	Pin No.	Signal	Pin No.	Signal
1	Red video	6	Red video ground	11	NC*
2	Green video	7	Green video ground	12	Data (SDA)
3	Blue video	8	Blue video ground	13	H. Sync
4	NC*	9	NC*	14	V. Sync
5	Ground	10	Ground	15	Clock (SCL)

(NC*: No Connection)

5-2. Glossary

Afterimage

The Afterimage is particular to LCD monitors. When the monitor screen is left on for a long period without use. The Afterimage can be removed gradually by changing the displayed image.

Clock

The analog input monitor needs to reproduce a clock of the same frequency as the dot clock of the graphics system in use, when the analog input signal is converted to a digital signal for image display. This is called clock adjustment. If the clock pulse is not set correctly, some vertical bars appear on the screen.

Phase

Phase means the sampling timing to convert the analog input signal to a digital signal. Phase adjustment is made to adjust the timing. It is recommended that phase adjustment be made after the clock is adjusted correctly.

Range Adjustment

Range adjustment controls the signal output levels to display every color gradation. It is recommended that range adjustment be made before color adjustment.

Resolution

The LCD panel consists of numerous pixels of specified size, which are illuminated to form images. This monitor consists of 1024 (FDX1001 / FDX1201) / 640 (FDV1001) horizontal pixels and 768 (FDX1001 / FDX1201) / 480 (FDV1001) vertical pixels.

At a resolution of 1024 × 768 (FDX1001 / FDX1201) / 640 × 480 (FDV1001), all pixels are illuminated as a full screen (1:1).

5-3. Preset Timing

The following table shows the factory preset video timing of the PC.

ATTENTION

- Display position may be deviated depending on the PC connected, which may require screen adjustment using Setting menu.
- If a signal other than those listed in the table is input, adjust the screen using the Setting menu. However, screen display may still be incorrect even after the adjustment.
- When interlace signals are used, the screen cannot be displayed correctly even after screen adjustment using the Setting menu.

FDX1001 / FDX1201

Resolution	Applicable signal	Frequency			Polarity	
		Dot clock : MHz	Horizontal : kHz	Vertical : Hz	Horizontal	Vertical
720 × 400	VGA TEXT	28.33	31.47	70.09	Negative	Positive
640 × 480	VGA	25.18	31.47	59.94	Negative	Negative
640 × 480	VESA	31.50	37.86	72.81	Negative	Negative
640 × 480	VESA	31.50	37.50	75.00	Negative	Negative
800 × 600	VESA	36.00	35.16	56.25	Positive	Positive
800 × 600	VESA	40.00	37.88	60.32	Positive	Positive
800 × 600	VESA	50.00	48.08	72.19	Positive	Positive
800 × 600	VESA	49.50	46.88	75.00	Positive	Positive
1024 × 768	VESA	65.00	48.36	60.00	Negative	Negative
640 × 480	MAC	30.24	35.00	66.67	Negative	Negative
832 × 624	MAC	57.28	49.72	74.55	Negative	Negative
640 × 400	PC-9801	21.05	24.83	56.42	Negative	Negative
640 × 400	PC-9821 AP2	25.18	31.48	70.10	Negative	Negative

FDV1001

Resolution	Applicable signal	Frequency			Polarity	
		Dot clock : MHz	Horizontal : kHz	Vertical : Hz	Horizontal	Vertical
720 × 400	VGA TEXT	28.33	31.47	70.09	Negative	Positive
640 × 480	VGA	25.18	31.47	59.94	Negative	Negative
800 × 600	VESA	36.00	35.16	56.25	Positive	Positive
800 × 600	VESA	40.00	37.88	60.32	Positive	Positive
1024 × 768	VESA	65.00	48.36	60.00	Negative	Negative
640 × 480	MAC	30.24	35.00	66.67	Negative	Negative
640 × 400	PC-9801	21.05	24.83	56.42	Negative	Negative
640 × 400	PC-9821 AP2	25.18	31.48	70.10	Negative	Negative

LIMITED WARRANTY

EIZO Corporation (hereinafter referred to as “EIZO”) and distributors authorized by EIZO (hereinafter referred to as the “Distributors”) warrant, subject to and in accordance with the terms of this limited warranty (hereinafter referred to as the “Warranty”), to the original purchaser (hereinafter referred to as the “Original Purchaser”) who purchased the product specified in this document (hereinafter referred to as the “Product”) from EIZO or Distributors, that EIZO and Distributors shall, at their sole discretion, either repair or replace the Product at no charge if the Original Purchaser becomes aware within the Warranty Period (defined below) that the Product malfunctions or is damaged in the course of normal use of the Product in accordance with the description in the instruction manual attached to the Product (hereinafter referred to as the “User’s Manual”).

The period of this Warranty is two (2) years from the date of purchase of the Product (hereinafter referred to as the “Warranty Period”). EIZO and Distributors shall bear no liability or obligation with regard to the Product in relation to the Original Purchaser or any third parties other than as provided under this Warranty.

EIZO and Distributors will cease to hold or store any parts of the Product upon expiration of seven (7) years after the production of such parts is discontinued. In repairing the monitor, EIZO and Distributors will use renewal parts which comply with our QC standards.

The Warranty is valid only in the countries or territories where the Distributors are located. The Warranty does not restrict any legal rights of the Original Purchaser.

Notwithstanding any other provision of this Warranty, EIZO and Distributors shall have no obligation under this Warranty whatsoever in any of the cases as set forth below:

- (a) Any defect of the Product caused by freight damage, modification, alteration, abuse, misuse, accident, incorrect installation, disaster, faulty maintenance and/or improper repair by third party other than EIZO and Distributors;
- (b) Any incompatibility of the Product due to possible technical innovations and/or regulations;
- (c) Any deterioration of the sensor;
- (d) Any deterioration of display performance caused by the deterioration of expendable parts such as the LCD panel and/or backlight, etc. (e.g. changes in brightness, changes in brightness uniformity, changes in color, changes in color uniformity, defects in pixels including burnt pixels, etc.);
- (e) Any defect of the Product caused by external equipment;
- (f) Any defect of the Product on which the original serial number has been altered or removed;
- (g) Any defect of the Product caused by liquid leaking from battery;
- (h) Any normal deterioration of the product, particularly that of consumables, accessories, and/or attachments (e.g. batteries, buttons, rotating parts, remote control, cables, User’s Manual, etc.); and
- (i) Any deformation, discoloration, and/or warp of the exterior of the product including that of the surface of the LCD panel.

To obtain service under the Warranty, the Original Purchaser must deliver the Product, freight prepaid, in its original package or other adequate package affording an equal degree of protection, assuming the risk of damage and/or loss in transit, to the local Distributor. The Original Purchaser must present proof of purchase of the Product and the date of such purchase when requesting services under the Warranty.

The Warranty Period for any replaced and/or repaired product under this Warranty shall expire at the end of the original Warranty Period.

EIZO OR DISTRIBUTORS ARE NOT RESPONSIBLE FOR ANY DAMAGE TO, OR LOSS OF, DATA OR OTHER INFORMATION STORED IN ANY MEDIA OR ANY PART OF ANY PRODUCT RETURNED TO EIZO OR DISTRIBUTORS FOR REPAIR.

EIZO AND DISTRIBUTORS MAKE NO FURTHER WARRANTIES, EXPRESSED OR IMPLIED, WITH RESPECT TO THE PRODUCT AND ITS QUALITY, PERFORMANCE, MERCHANTABILITY OR FITNESS FOR ANY PARTICULAR USE. IN NO EVENT SHALL EIZO OR DISTRIBUTORS BE LIABLE FOR ANY INCIDENTAL, INDIRECT, SPECIAL, CONSEQUENTIAL OR OTHER DAMAGE WHATSOEVER (INCLUDING, WITHOUT LIMITATION, DAMAGES FOR LOSS OF PROFIT, BUSINESS INTERRUPTION, LOSS OF BUSINESS INFORMATION, OR ANY OTHER PECUNIARY LOSS) ARISING OUT OF THE USE OR INABILITY TO USE THE PRODUCT OR IN ANY CONNECTION WITH THE PRODUCT, WHETHER BASED ON CONTRACT, TORT, NEGLIGENCE, STRICT LIABILITY OR OTHERWISE, EVEN IF EIZO OR DISTRIBUTORS HAVE BEEN ADVISED OF THE POSSIBILITY OF SUCH DAMAGES. THIS EXCLUSION ALSO INCLUDES ANY LIABILITY WHICH MAY ARISE OUT OF THIRD PARTY CLAIMS AGAINST THE ORIGINAL PURCHASER. THE ESSENCE OF THIS PROVISION IS TO LIMIT THE POTENTIAL LIABILITY OF EIZO AND DISTRIBUTORS ARISING OUT OF THIS LIMITED WARRANTY AND/OR SALES.



EIZO Corporation

153 Shimokashiwano, Hakusan, Ishikawa 924-8566 Japan
Phone: +81 76 277 6792 Fax: +81 76 277 6793

EIZO Europe GmbH

Helmut-Grashoff-Strasse 18, 41179 Mönchengladbach, Germany
Phone: +49 2161 8210210 Fax: +49 2161 8210150

艺卓显像技术(苏州)有限公司

中国苏州市苏州工业园区展业路8号中新科技工业坊5B
Phone: +86 512 6252 0100 Fax: +86 512 6252 1508

<http://www.eizo.com>

Copyright © 2010-2013 EIZO Corporation All rights reserved.

4th Edition-April, 2013 Printed in Japan.

00NOL623D1
(U.M-FDX1001-R-AL)