

OUTLINE DIMENSIONS

MODEL EV3895

UNIT mm

EIZO Corporation

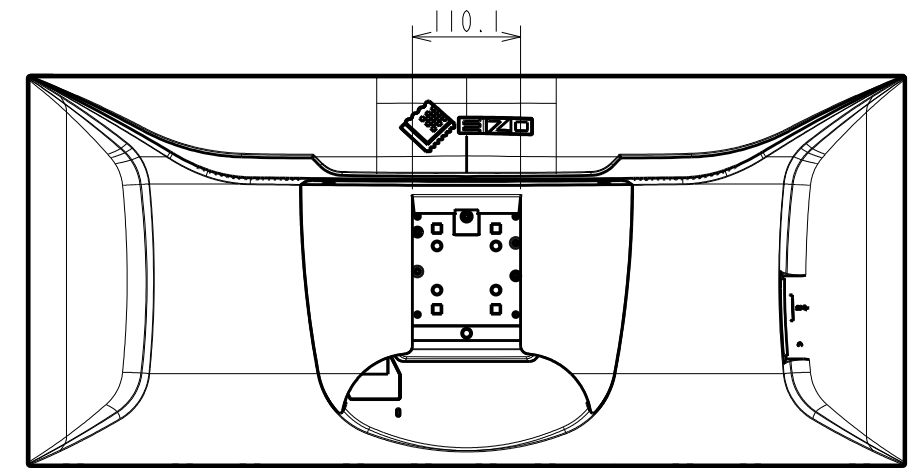
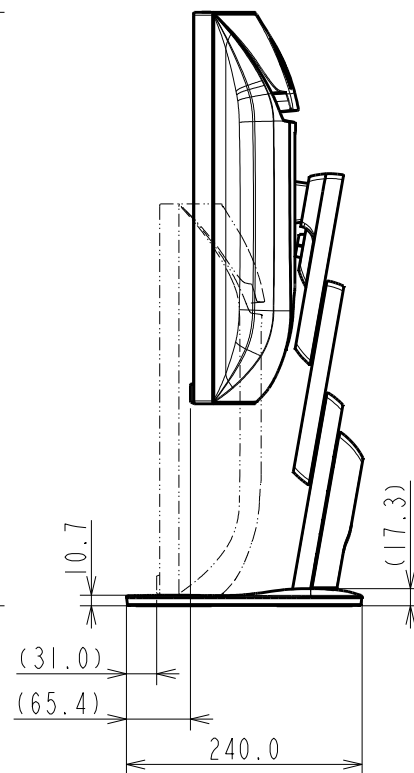
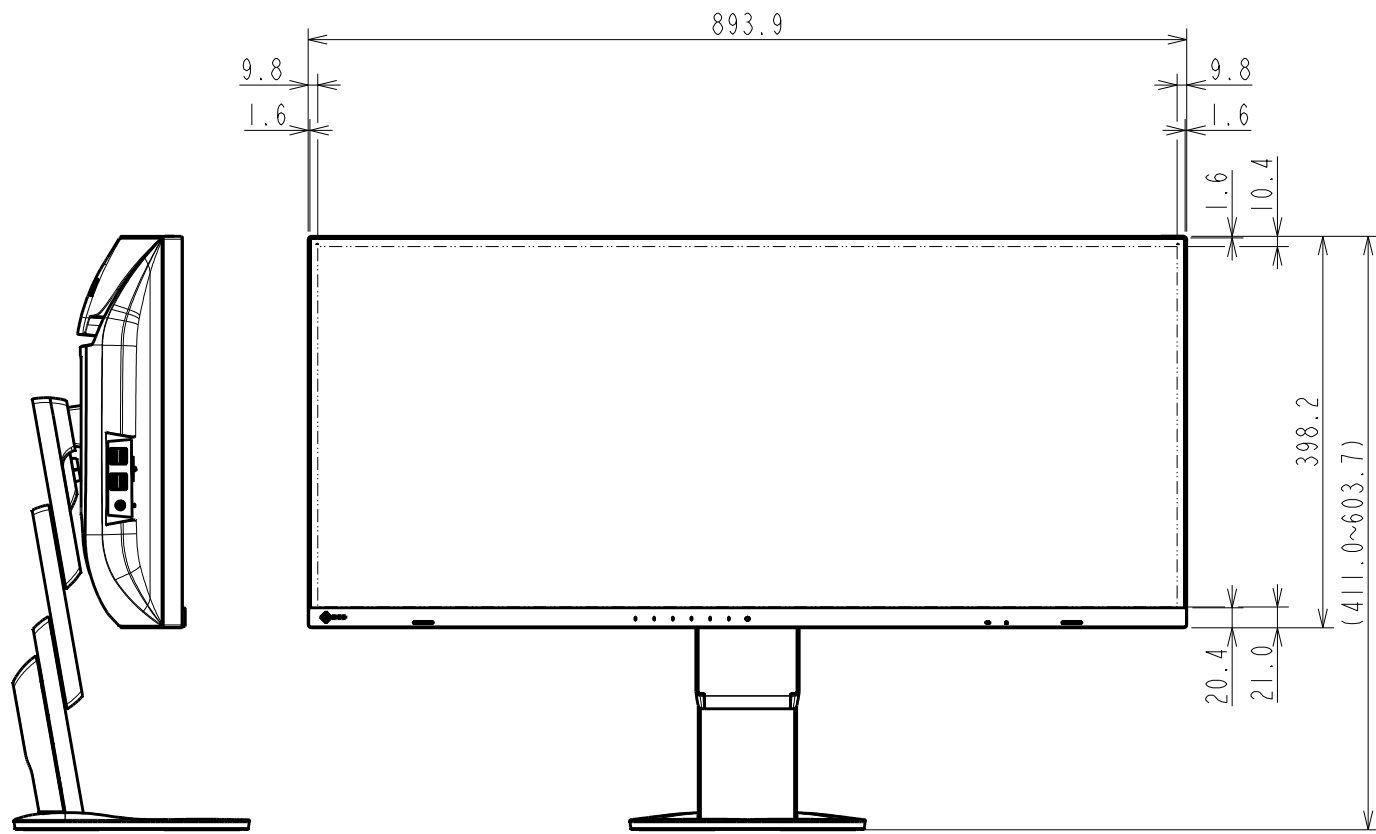
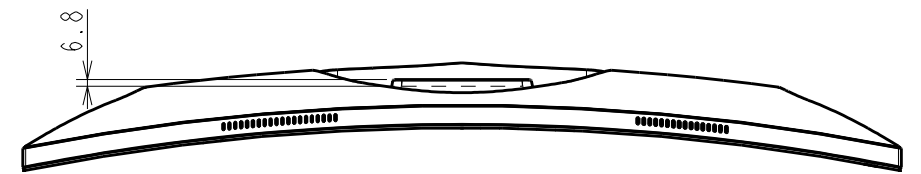
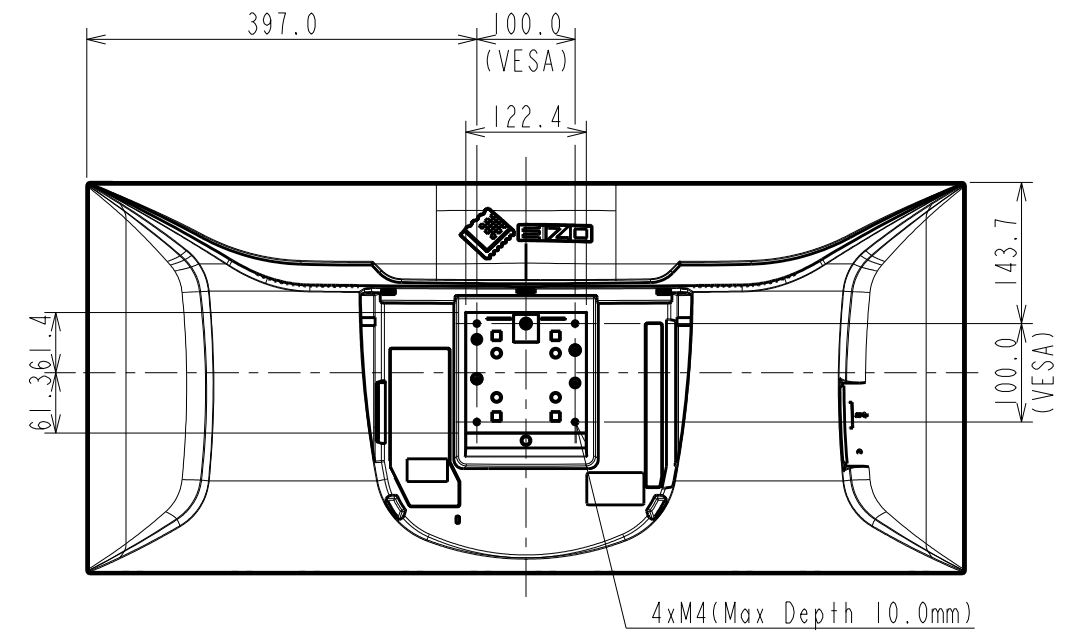
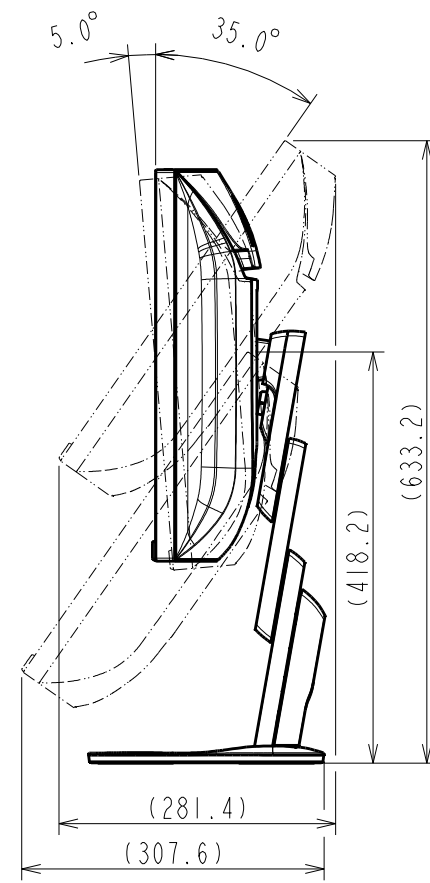
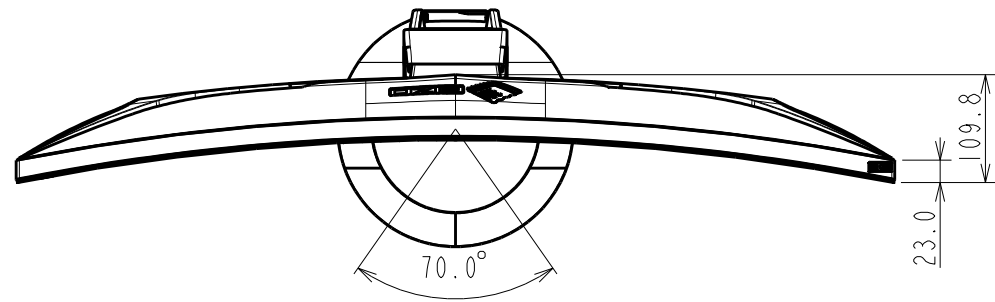

OUTLINE DIMENSIONS

MODEL EV3895

UNIT mm

EIZO Corporation

