

User's Manual  
Bedienungsanleitung  
Manuel d'utilisation

# FlexScan L362T

Touch Panel Color LCD Monitor  
LCD-Farbmonitor mit Touch-Panel  
Moniteur couleur LCD à écran tactile

## **Important**

Please read this User's Manual carefully to familiarize yourself with safe and effective usage. Please retain this manual for future reference.

## **Wichtig**

Bitte lesen Sie diese Bedienungsanleitung sorgfältig durch, um sich mit dem sicheren und rationellen Betrieb dieses Produkts vertraut zu machen. Bewahren Sie das vorliegende Handbuch zu Referenzzwecken auf.

## **Important**

Veuillez lire attentivement ce Manuel d'utilisation afin de vous familiariser avec ce produit et de l'utiliser efficacement et en toute sécurité. Veuillez conserver ce manuel pour référence ultérieure.



For U.S.A, Canada, etc. (rated 100-120 Vac) Only

## FCC Declaration of Conformity

We, the Responsible Party

EIZO NANAOTECHNOLOGIES INC.  
5710 Warland Drive, Cypress, CA 90630  
Phone: (562) 431-5011

declare that the product

Trade name: EIZO  
Model: FlexScan L362T

is in conformity with Part 15 of the FCC Rules. Operation of this product is subject to the following two conditions: (1) this device may not cause harmful interference, and (2) this device must accept any interference received, including interference that may cause undesired operation.

This equipment has been tested and found to comply with the limits for a Class B digital device, pursuant to Part 15 of the FCC Rules. These limits are designed to provide reasonable protection against harmful interference in a residential installation. This equipment generates, uses, and can radiate radio frequency energy and, if not installed and used in accordance with the instructions, may cause harmful interference to radio communications. However, there is no guarantee that interference will not occur in a particular installation. If this equipment does cause harmful interference to radio or television reception, which can be determined by turning the equipment off and on, the user is encouraged to try to correct the interference by one or more of the following measures.

- \* Reorient or relocate the receiving antenna.
- \* Increase the separation between the equipment and receiver.
- \* Connect the equipment into an outlet on a circuit different from that to which the receiver is connected.
- \* Consult the dealer or an experienced radio/TV technician for help.

Changes or modifications not expressly approved by the party responsible for compliance could void the user's authority to operate the equipment.

### Note

Use the attached specified cable below or EIZO signal cable with this monitor so as to keep interference within the limits of a Class B digital device.

- AC Cord
- Shielded Signal Cable
- Stereo mini-jack cable

## Canadian Notice

This Class B digital apparatus complies with Canadian ICES-003.

Cet appareil numérique de la classe B est conforme à la norme NMB-003 du Canada.

# User's Manual

# FlexScan® L362T

Touch Panel Color LCD Monitor

It shall be assured that the final system is in compliance to IEC60601-1-1 requirement.

## SAFETY SYMBOLS

This manual uses the safety symbols below. They denote critical information. Please read them carefully.



### WARNING

Failure to abide by the information in a WARNING may result in serious injury and can be life threatening.



### CAUTION

Failure to abide by the information in a CAUTION may result in moderate injury and/or property or product damage.



Indicates a prohibited action.



Indicates to ground for safety.

• This product has been adjusted specifically for use in the region to which it was originally shipped. If operated outside this region, the product may not perform as stated in the specifications.

• Power supplied equipment can emit electromagnetic waves, that could influence, limit or result in malfunction of the monitor. Install the equipment in a controlled environment, where such effects are avoided.

• This is a monitor intended for use in a medical imaging system. It does not support the display of mammography images for diagnosis.

---

No part of this manual may be reproduced, stored in a retrieval system, or transmitted, in any form or by any means, electronic, mechanical, or otherwise, without the prior written permission of EIZO NANA O CORPORATION.

EIZO NANA O CORPORATION is under no obligation to hold any submitted material or information confidential unless prior arrangements are made pursuant to EIZO NANA O CORPORATION's receipt of said information. Although every effort has been made to ensure that this manual provides up-to-date information, please note that EIZO monitor specifications are subject to change without notice.

---

VGA is a registered trademark of International Business Machines Corporation.

VESA is a registered trademark or a trademark of Video Electronics Standards Association in the United States and other countries.

Mac is a registered trademark of Apple Inc.

TouchWare is a trademark of 3M in the United States and other countries.

Windows and Windows Vista are registered trademarks of Microsoft Corporation in the United States and other countries.

PowerManager is a trademark of EIZO NANA O COROPRATION.

ScreenManager, FlexScan and EIZO are registered trademarks of EIZO NANA O CORPORATION in Japan and other countries.

All other company and product names are trademarks or registered trademarks of their respective owners.

---

# TABLE OF CONTENTS

 <b>PRECAUTIONS</b> .....	<b>4</b>
<b>1. INTRODUCTION</b> .....	<b>9</b>
1-1. Features .....	9
1-2. Package Contents.....	9
1-3. Controls & Connectors .....	10
<b>2. CABLE CONNECTION</b> .....	<b>12</b>
2-1. Before connecting .....	12
2-2. Connecting the signal cable .....	13
2-3. Connecting two PCs to the monitor.....	15
2-4. Sound Connections.....	15
<b>3. ScreenManager</b> .....	<b>16</b>
3-1. How to use the ScreenManager .....	16
3-2. Adjustments and Settings.....	17
3-3. Useful Functions .....	18
<b>4. ADJUSTMENT</b> .....	<b>20</b>
4-1. Screen Adjustment .....	20
4-2. Color Adjustment .....	24
4-3. Power-save Setup .....	26
<b>5. ATTACHING A STAND</b> .....	<b>28</b>
<b>6. TROUBLESHOOTING</b> .....	<b>29</b>
<b>7. CLEANING</b> .....	<b>33</b>
<b>8. SPECIFICATIONS</b> .....	<b>34</b>
<b>9. GLOSSARY</b> .....	<b>37</b>
<b>APPENDIX/ANHANG/ANNEXE</b> .....	<b>i</b>

# PRECAUTIONS



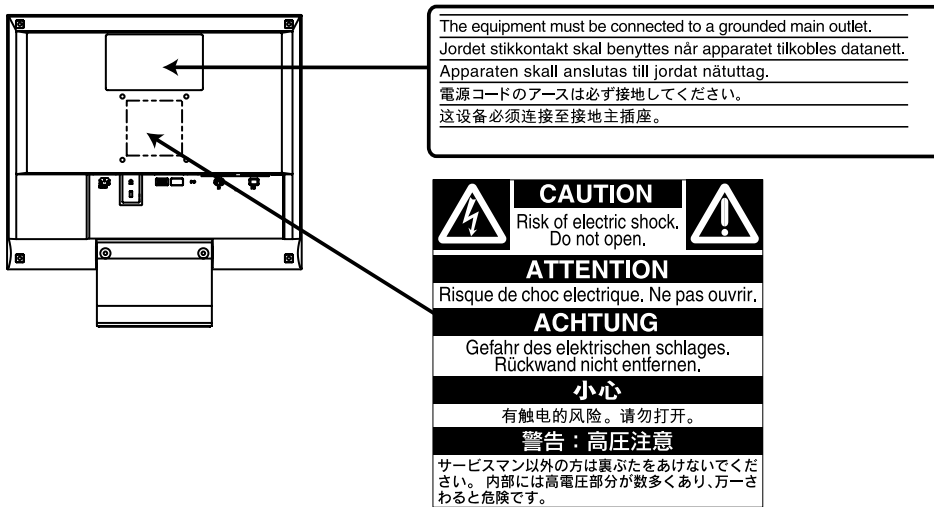

## IMPORTANT!

- This product has been adjusted specifically for use in the region to which it was originally shipped. If operated outside the region to which it was originally shipped, the product may not perform as stated in the specifications.
- To ensure personal safety and proper maintenance, please read this section and the caution statements on the unit (refer to the figure below).

### [Location of the Caution Statements]



### [Symbols on the unit]

Symbol	Location	This symbol indicates
	Front Control panel	Power button Press to turn the monitor's power on or off.
	Rear Name Plate	Alternating current
	Rear	Alerting electrical hazard
	Rear	Caution Refer to SAFETY SYMBOLS section in this manual.

## WARNING

**If the unit begins to emit smoke, smells like something is burning, or makes strange noises, disconnect all power connections immediately and contact your dealer for advice.**

Attempting to use a malfunctioning unit may result in fire, electric shock, or equipment damage.

### **Do not open the cabinet or modify the unit.**

Opening the cabinet or modifying the unit may result in fire, electric shock, or burn.



### **Refer all servicing to qualified service personnel.**

Do not attempt to service this product yourself as opening or removing covers may result in fire, electric shock, or equipment damage.

### **Keep small objects or liquids away from the unit.**

Small objects accidentally falling through the ventilation slots into the cabinet or spillage into the cabinet may result in fire, electric shock, or equipment damage.

If an object or liquid falls/spills into the cabinet, unplug the unit immediately. Have the unit checked by a qualified service engineer before using it again.

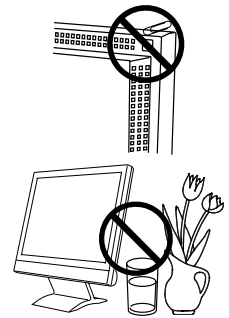

### **Place the unit at the strong and stable place.**

A unit placed on an inadequate surface may fall and result in injury or equipment damage.

If the unit falls, disconnect the power immediately and ask your dealer for advice. Do not continue using a damaged unit. Using a damaged unit may result in fire or electric shock.

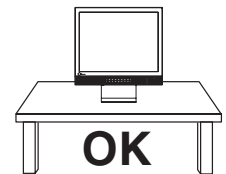

### **Use the unit in an appropriate location.**

Not doing so may result in fire, electric shock, or equipment damage.

- \* Do not place outdoors.
- \* Do not place in the transportation system (ship, aircraft, trains, automobiles, etc.)
- \* Do not place in a dusty or humid environment.
- \* Do not place in a location where water is splashed on the screen (bathroom, kitchen, etc.).
- \* Do not place in a location where the steam comes directly on the screen.
- \* Do not place near heat generating devices or a humidifier.
- \* Do not place in an inflammable gas environment.



## **WARNING**

---

**To avoid danger of suffocation, keep the plastic packing bags away from babies and children.**

---

**Use the enclosed power cord and connect to the standard power outlet of your country.**

Be sure to remain within the rated voltage of the power cord.

Not doing so may result in fire or electric shock.

Power Supply: 100-120/200-240 Vac 50/60Hz

---

**To disconnect the power cord, grasp the plug firmly and pull.**

Tugging on the cord may damage and result in fire or electric shock.



**The equipment must be connected to a grounded main outlet.**

Failure to do so may result in fire or electric shock.



**Use the correct voltage.**

\* The unit is designed for use with a specific voltage only. Connection to another voltage than specified in this User's Manual may cause fire, electric shock, or equipment damage.

Power Supply: 100-120/200-240 Vac 50/60Hz

\* Do not overload your power circuit, as this may result in fire or electric shock.

---

**Handle the power cord with care.**

\* Do not place the cord underneath the unit or other heavy objects.

\* Do not pull on or tie the cord.

If the power cord becomes damaged, stop using it. Use of a damaged cord may result in fire or electric shock.



**For the electrical safety, do not connect or disconnect the power cord in the presence of patients.**

---

**Never touch the plug and power cord if it begins to thunder.**

Touching them may result in electric shock.



**When attaching an arm stand, please refer to the user's manual of the arm stand and install the unit securely.**

Not doing so may cause the unit to become unattached, which may result in injury or equipment damage. Before installation, make sure that desks, walls, and others an arm stand is fixed on have adequate mechanical strength. When the unit is dropped, please ask your dealer for advice. Do not continue using a damaged unit. Using a damaged unit may result in fire or electric shock. When reattaching the tilt stand, please use the same screws and tighten them securely.

---



## WARNING

### **Do not touch a damaged LCD panel directly with bare hands.**

The liquid crystal that may leak from the panel is poisonous if it enters the eyes or mouth.

If any part of the skin or body comes in direct contact with the panel, please wash thoroughly.

If some physical symptoms result, please consult your doctor.



### **Fluorescent backlight lamps contain mercury (the products that have LED backlight lamps contain no mercury), dispose according to local, state or federal laws.**

Exposure to elemental mercury can result in effects on the nervous system, including tremor, memory loss, and headache.

## CAUTION

### **Handle with care when carrying the unit.**

Disconnect the power cord and cables when moving the unit. Moving the unit with the cord attached is dangerous. It may result in injury.

### **When handling the unit, grip the bottom of the unit firmly with both hands ensuring the panel faces outward before lifting.**

Dropping the unit may result in injury or equipment damage.

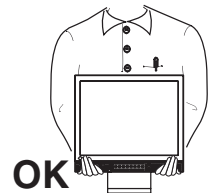

### **Do not block the ventilation slots on the cabinet.**

- \* Do not place any objects on the ventilation slots.
- \* Do not install the unit in a closed space.
- \* Do not use the unit laid down or upside down.

Blocking the ventilation slots prevents proper airflow and may result in fire, electric shock, or equipment damage.



### **Do not touch the plug with wet hands.**

Doing so may result in electrical shock.



### **Use an easily accessible power outlet.**

This will ensure that you can disconnect the power quickly in case of a problem.

### **Periodically clean the area around the plug.**

Dust, water, or oil on the plug may result in fire.

### **Unplug the unit before cleaning it.**

Cleaning the unit while it is plugged into a power outlet may result in electric shock.

## **CAUTION**

---

**If you plan to leave the unit unused for an extended period, disconnect the power cord from the wall socket after turning off the power switch for the safety and the power conservation.**

---

**This product is only suitable for a patient environment, but not for contact with a patient.**

---

## **Notice for this monitor**

---

This product is suited to general purposes like creating documents, viewing multimedia content.

---

Monitors should be set to a lower brightness to reduce changes in luminosity caused by long-term use and maintain a stable display.

---

The LCD panel is manufactured using high-precision technology. Although, missing pixels or lit pixels may appear on the LCD panel, this is not a malfunction. Percentage of effective dots: 99.9994% or higher.

---

The backlight of the LCD panel has a fixed life span. When the screen becomes dark or begins to flicker, please contact your dealer.

---

Do not scratch or press on the panel with any sharp objects, as this may result in damage to the panel. Do not attempt to brush with tissues as this may scratch the panel.

---

When the screen image is changed after displaying the same image for extended periods of time, an afterimage may appear. Use the screen saver or power save function to avoid displaying the same image for extended periods of time.

---

When the monitor is cold and brought into a room or the room temperature goes up quickly, dew condensation may occur on the interior and exterior surfaces of the monitor. In that case, do not turn the monitor on. Instead wait until the dew condensation disappears, otherwise it may cause some damage to the monitor.

---

## **To use the monitor comfortably**

---

An excessively dark or bright screen may affect your eyes. Adjust the brightness of the monitor according to the environmental conditions.

---

Staring at the monitor for a long time tires your eyes. Take a 10-minute rest every hour.

---

---

# 1. INTRODUCTION

Thank you very much for choosing an EIZO Color Monitor.

## 1-1. Features

- Dual inputs compliant
- DVI (p.37) Digital input (TMDS (p.38)) compliant.
- Horizontal scanning frequency: Analog input 24 - 61 kHz  
Digital input 31 - 49 kHz
- Vertical scanning frequency: Analog input 55 - 75 Hz  
Digital input 59 - 61 Hz (VGA text: 70 Hz)
- Resolution: 0.8 M pixels (1024 dots x 768 lines)
- Auto Adjustment compliant
- Support to sRGB (p.38) standard
- Built-in speaker system
- Touch Panel provided
- Touch Panel Pointer “TP1” is available (optional, p.14)

## 1-2. Package Contents

Please contact your local dealer for assistance if any of the listed items are missing or damaged.

- LCD Monitor
- Power Cord
- Signal Cable (MD-C87)
- Touch Panel Cable (FD-C38)
- Stereo mini-jack Cable
- User's Manual
- ScreenManager Quick Reference
- LIMITED WARRANTY
- Mounting Screws: M4 x 12 (mm) x 4 pcs
- EIZO Touch Panel Disk (CD-ROM)  
(Contents: touch panel drivers TouchWare (for Windows 2000/XP) and MT 7 (for Windows Vista), and Installation Guides)

### **NOTE**

- Please retain the packing materials for future transference.
- Regarding installing touch panel drivers and cautions, please refer to the Installation Guides in the CD-ROM.

# 1-3. Controls & Connectors

## Front

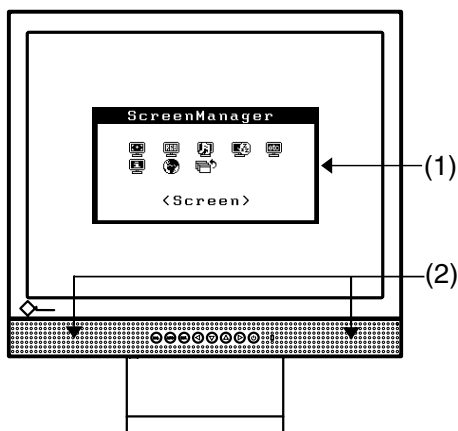

Control Panel

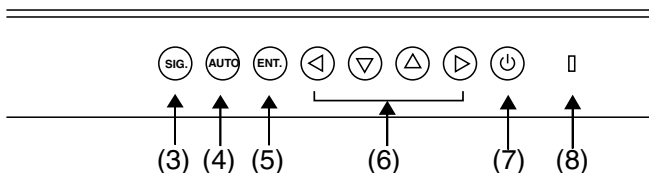

- (1) ScreenManager®
- (2) Speaker<sup>\*1</sup>

Volume Control	Press the Right and Left Buttons.
Mute	Press the Up or Down Button for a while after pressing the Right or Left Button to display the volume control bar. Press the Right or Left Button to mute off.

- (3) Input Signal Selection Button
- (4) Auto Adjustment Button
- (5) Enter Button
- (6) Control Buttons (Left, Down, Up, Right)
- (7) Power Switch
- (8) Power Indicator<sup>\*2</sup>

Blue	Operation
Yellow	Power saving
Flashing yellow (2 times for each)	Power save mode Digital only
Flashing yellow slowly	Power off

<sup>\*1</sup> Regarding the sound connection, see page 15.

<sup>\*2</sup> Regarding the power indicator for the off timer, see page 18.

## Rear

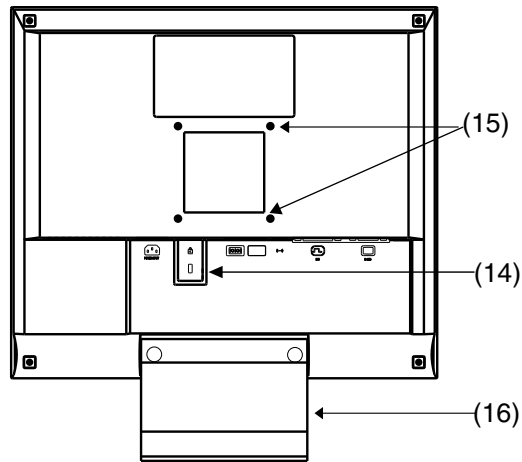

## Bottom

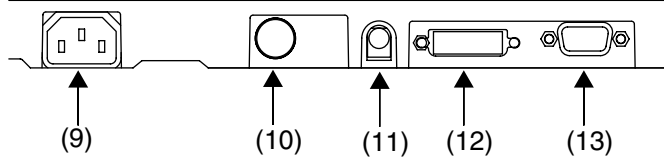

- (9) Power Connector
- (10) RS-232C port (Mini DIN 6 pin)
- (11) External line in (stereo mini-jack)
- (12) DVI-D Connector (SIGNAL 1)
- (13) D-Sub mini 15 pin Connector (SIGNAL 2)
- (14) Security Lock Slot<sup>\*3</sup>
- (15) 4 Holes for Mounting a stand<sup>\*4</sup>
- (16) Stand (Detachable)<sup>\*4</sup>

<sup>\*3</sup> Allows for connection of a security cable. This lock supports Kensington's MicroSaver security system.

<sup>\*4</sup> The LCD monitor can be used with an other stand by removing the stand (see page 28).

# 2. CABLE CONNECTION

## 2-1. Before connecting

Before connecting your monitor to the PC, change the display screen settings (resolution (p.38) and frequency) in accordance with the charts below.

### NOTE

- The lower display modes like 640x 480, automatically enlarge to the maximum display mode (1024 x 768), and some lines of the characters may become fuzzy. In this case, use <Smoothing> function (p.22) to make the lines clear.
- When your computer and display support VESA DDC, the suitable resolution and the refresh rate are set by just plugging your display into the computer without any manual settings.

### Analog Input

Resolution	Frequency	Dot Clock	Remarks
320 x 200	70 Hz	79 MHz (Max)	VGA Mode13
640 x 480	~75 Hz		VGA, VESA
720 x 400	70 Hz		VGA TEXT
800 x 600	~75 Hz		VESA
1024 x 768	~75 Hz		VESA

### Digital Input

Resolution	Frequency	Dot Clock	Remarks
640 x 480	60 Hz	66 MHz (Max)	VGA
720 x 400	70 Hz		VGA TEXT
800 x 600	60 Hz		VESA
1024 x 768	60 Hz		VESA

## 2-2. Connecting the signal cable

### NOTE

- Be sure that the power switches of both the PC and the monitor are OFF.

1. Plug the signal cable into the connector at the rear of the monitor and the other end of the cable into the video connector on the PC.

After connecting, secure the connection with the screw-in fasteners.

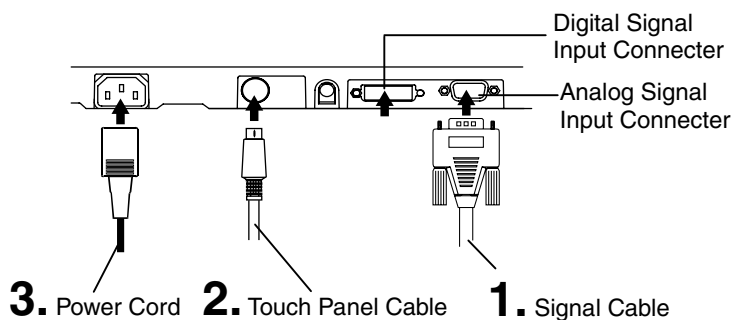

### Analog Input

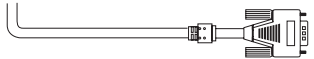
Signal Cable	Connector of PC	PC
Signal Cable (enclosed, MD-C87) 	Video Output Connector/ D-Sub mini 15 pin Input Connector (monitor)/ D-Sub mini 15 pin	<ul style="list-style-type: none"> <li>• Standard graphics card</li> </ul>

### Digital Input

Signal Cable	Connector of PC	PC
FD-C39 (Optional) 	Video Output Connector DVI-I Input Connector (monitor)/ DVI	<ul style="list-style-type: none"> <li>• Digital Graphics card</li> </ul>

2. Plug the enclosed touch panel cable into the RS-232C port of the monitor. Then, plug the other end of the cable into the COM port of the computer.
3. Plug the power cord into the power connector on the rear of the monitor. Then, plug the other end of the cord into a power outlet.

---

 **WARNING**

---

**Use the enclosed power cord and connect to the standard power outlet of your country.**

Be sure to remain within the rated voltage of the power cord.  
Not doing so may cause in fire or electric shock.

---

**The equipment must be connected to a grounded main outlet.**

Not doing so may cause in fire or electric shock.

---



4. Turn on the monitor's main power and then switch on the PC's power.  
The monitor's power indicator will light up (blue).  
If an image does not appear, refer to the "6. TROUBLESHOOTING" (p.29) for advice.  
Whenever finished, turn off the PC and the monitor.
5. Install the touch panel driver TouchWare (for Windows 2000/XP) or MT 7 (for Windows Vista) depending on your OS.

**NOTE**

- Regarding installing touch panel drivers and cautions, please refer to the Installation Guides in the CD-ROM.

**NOTE**

- Adjust brightness of the screen depending on the brightness of your environment. Too dark or too bright of a screen can cause eyestrain.
- Be sure to take adequate rests. A 10-minute rest period each hour is suggested.
- For the users with gloves, we recommend to use touch panel pointer, "TP1" (optional). Regarding the installation, please refer to the User's Manual of TP1.



## 2-3. Connecting two PCs to the monitor

Two PCs can be connected to the monitor through the DVI and the D-Sub mini 15 pin connector on the back of the monitor.

### Selecting the active input

The Input Signal Selection Button on the control panel can be used to select either Signal 1 or Signal 2 as the active input at any time. Every time the button is pressed, the input changes. When switching the signal, the kind of the input signal (Signal1 or 2/Analog or Digital) is displayed for a few seconds on the right top corner of the screen.

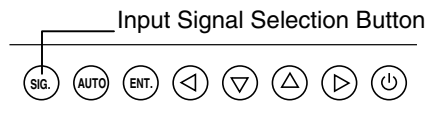

## 2-4. Sound Connections

### NOTE

- Always switch the monitor and audio devices or computers off whenever connecting or disconnecting any audio devices (computer or CD player) to the monitor.
- Use the enclosed stereo mini-jack cable for connecting audio devices or computers to the monitor.
- The touch sound may not be output from the external line out of the PC depending on the hardware configuration.

1. Connect the stereo mini-jack cable to the external line in of the monitor.
2. Connect the other side of stereo mini-jack cable to the line out of audio devices.



### Volume control

Volume control	Press the Right and Left Buttons.
Mute	Press the Up or Down Button for a while after pressing the Right or Left Button to display the volume control bar.
Mute off	Press the Right or Left Button.

### NOTE

- <Sound> menu of the ScreenManager also controls the sound.

# 3. ScreenManager

## 3-1. How to use the ScreenManager

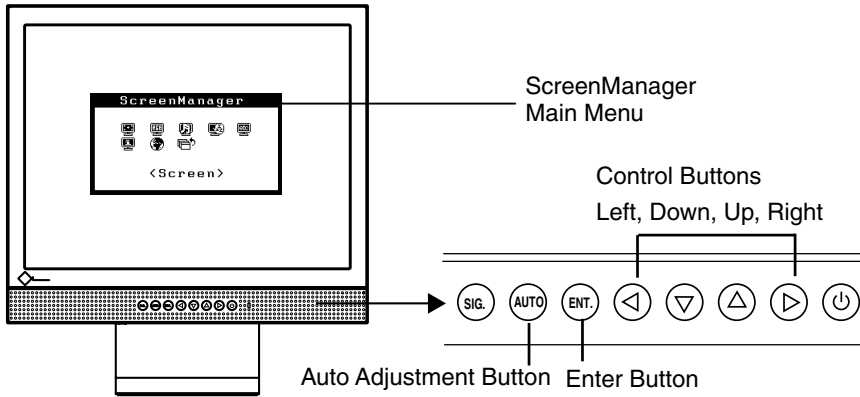

### 1. Entering the ScreenManager

Press the Enter Button once to display the main menu of the ScreenManager.

### 2. Making Adjustments and Settings

- (1) Select the desired sub menu icon using the Control Buttons and press the Enter Button. The sub menu appears.
- (2) Use the Control Buttons to select the desired setting icon and press the Enter Button. The setting menu appears.
- (3) Use the Control Buttons to make all required adjustments and press the Enter Button to save the settings.

### 3. Exiting the ScreenManager

- (1) To return to the main menu, select the <Return> icon or press the Down Button twice, followed by the Enter Button.
- (2) To exit the ScreenManager, select <Exit> icon or press the Down Button twice, followed by the Enter Button.

#### **NOTE**

- Double clicking the Enter Button at any time also exits the ScreenManager menu.

## 3-2. Adjustments and Settings

The following table shows all the ScreenManager's adjustment and setting menus. “\*” indicates adjustments of analog input only and “\*\*” indicates digital input only.

Main menu	Sub menu	Reference
Screen	Clock *	4-1. Screen Adjustment (p.20)
	Phase *	
	Position *	
	Range Adjustment *	
	Smoothing	
Color	Brightness	4-2. Color Adjustment (p.24)
	Color Mode	
	• Custom	
	Temperature	
	Gamma	
	Saturation	
	Hue	
	Gain	
	Reset	
	• sRGB	
Sound	Volume	Control the sound volume.
	Mute	Mute the sound.
PowerManager	DVI DMPM **	4-3. Power-save Setup (p.26)
	VESA DPMS *	
	Sound	
Others	Input Signal	Set the input signal selection of automatic or manual (p.19)
	Off Timer	Set the power save (p.18)
	VGA Selection	Select the display mode. (p.30)
	Menu Position	Adjust the menu position.
	Translucent	Set the transparency of the menu.
	Menu Off Timer	Set the menu displaying time.
	Reset	Return to the factory default settings. (p.35)
Information	Information	Review the ScreenManager's settings, model name, serial number and usage time <sup>1</sup> .
Language	English, German, French, Spanish, Italian and Swedish	Select the ScreenManager's language.

<sup>1</sup> Due to the inspection on the factory, the usage time may not “0 hour” at shipping.

## 3-3. Useful Functions

### Adjustment Lock

Use the “Adjustment Lock” function to prevent any accidental changes.

Locked function	<ul style="list-style-type: none"> <li>• Auto Adjustment Button adjustments and settings in the ScreenManager.</li> </ul>
Unlocked function	<ul style="list-style-type: none"> <li>• Adjustment of brightness by the Control Buttons.</li> <li>• Sound control by the Control Buttons.</li> <li>• Input Signal Selection Button</li> </ul>

[To lock]

- (1) Switch off the monitor’s power by the power switch on the control panel.
- (2) Press on the Auto adjustment button while switching on the monitor’s power.

[To unlock]

- (1) Switch off the monitor’s power by the power switch on the control panel.
- (2) Hold down the Auto adjustment button once again and turn the power back on.

### Off Timer

The off timer function causes the monitor to automatically enter a power off state after a predetermined amount of time has lapsed. This function was created to reduce afterimage characteristics that are particular to LCD monitors when the monitor screen is left on for a long period without use.

[Procedure]

- (1) Select <Off Timer> in the ScreenManager <Others> menu.
- (2) Select “Enable” and press the Right and Left Buttons to adjust the “On Period” (1 to 23 hours).

[Off timer system]

PC	Monitor	Power Indicator
On Period (1H - 23H)	Operation	Blue
Last 15 min. in “On period”	Advance Notice <sup>1</sup>	Blue Flashing
“On period” expired	Power off	Flashing yellow slowly

<sup>1</sup> Advance notice (Power Indicator flashing blue) will be given 15 minutes before the monitor automatically enters the “Power Off” mode. To delay entering the “Power Off” mode, press the power switch during the advance notice period. The monitor will continue to operate for an additional 90 minutes.

[Power Resumption Procedure]

Press the power switch.

#### NOTE

- The off timer function works while the PowerManager is active, but there is no advance notice before the monitor’s power is switched off.

## **EIZO Logo disappearing function**

When switching on the Power Switch on the control panel, the EIZO logo is displayed for a while. If you desire to display or undisplay this logo, use this function. (Default is logo appearing.)

### **[To undisplay]**

- (1) Switch off the monitor's power by the Power switch on the control panel.
- (2) Hold down the Enter button once again and turn the power back on.

### **[To display again]**

- (1) Switch off the monitor's power by the Power switch.
- (2) Hold down the Enter button once again and turn the power back on.

## **Automatically selecting the input signal function**

The monitor will automatically detect the inputted signal of either the connection for display.

## **Connecting two PCs to the monitor**

When the one computer is switched off or entering the power saving mode, the monitor will automatically display the other signal.

Use the ScreenManager to switch the input selection to manual.

### **[Procedure]**

- (1) Select <Input Signal> in the <Others> menu.
- (2) Select "Manual".

# 4. ADJUSTMENT

The monitor displays the digital input image correctly based on its pre-setting data. Adjust the brightness (p.23).

## 4-1. Screen Adjustment

Screen adjustments for the LCD monitor should be used in suppressing screen flickering and also for adjusting the screen to its proper position. There is only one correct position for each display mode. It is also recommended to use the ScreenManager function when first installing the display or whenever changing the system.

### Adjustment Procedure

#### **NOTE**

- Allow the LCD monitor to stabilize for at least 20 minutes before making image adjustments.

#### **1. Press the Auto Adjustment Button on the control panel.**

The message “Your setting will be lost, if you press again now.” appears and remains on the screen for 5 seconds. While the message is on the screen, press the Auto Adjustment Button again to automatically adjust the clock, phase, and screen position. If you do not wish to do adjust the screen, do not press the Auto Adjustment Button again.

#### **NOTE**

- The Auto Adjustment function is intended for use on AT-compatible PC running Windows. It may not work properly in either of the following cases. When running an AT-compatible PC on MS-DOS (Not windows). The background color for the “wall paper” or “desktop” pattern is set to black.

**If the appropriate screen can not be made by using the Auto Adjustment Button, adjust the screen through the following procedures. If the appropriate screen can be made, proceed to step 4.**

2. We recommend setting the desktop pattern to that as shown in the diagram below.

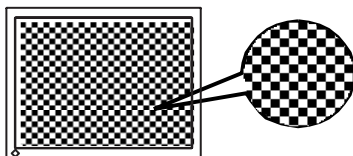

**NOTE**

- More precise adjustment is available for using the “Screen Adjustment program” utility software. It can be downloaded from the EIZO homepage (<http://www.eizo.com/>).

3. Adjust by using <Screen> menu in the ScreenManager.

- (1) Vertical bars appear on the screen

→  Use the <Clock> (p.37) adjustment.

Select the <Clock> and eliminate the vertical bars by using the Right and Left of the Control Buttons.

Do not continuously press the Control Buttons, as the adjustment value will change quickly and make it difficult to locate the most suitable adjustment point. If the horizontal flickering, blur or bars appear, proceed to <Phase> adjustment as follows.

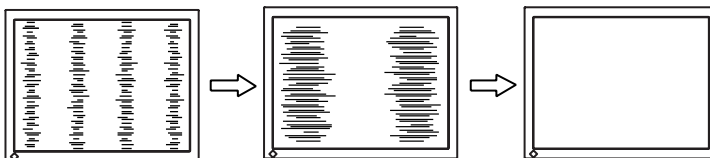

- (2) Horizontal bars appear on the screen.

→  Use the <Phase> (p.38) adjustment.

Select the <Phase> and eliminate the horizontal flickering, blurring or bars by using the Right and Left Buttons.

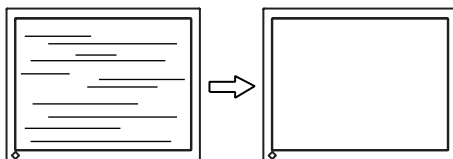

**NOTE**

- Horizontal bars may not completely disappear from the screen depending on the PC.



## (3) The screen position is incorrect.

→  Use the <Position> adjustment.

The correct displayed position of the monitor is decided because the number and the position of the pixels are fixed. The “Position” adjustment moves the image to the correct position.

Select <Position> and adjust the position by using the Up, Down, Right and Left Buttons.

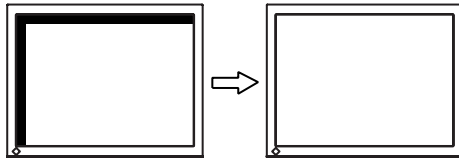
If vertical bars of distortion appear after finishing the <Position> adjustment, return to <Clock> adjustment and repeat the previously explained adjustment procedure. Clock→ Phase→ Position

4. To adjust the output signal range (Dynamic Range) of the signal.→  Use the <Range Adjustment> (p.38) of <Screen> menu.

This controls the level of output signal range to display the whole color gradation (256 colors).

## [Procedure]

Press the Auto Adjustment Button on the control panel while displaying the <Range Adjustment> menu to automatically adjust the range. The screen blanks for a moment, and adjusts the color range to display the whole color gradation of the current output signal.

## 5. To smooth the blurred texts of the enlarged screen of the lower resolutions.

→  Switch the <Smoothing> setting.

<Smoothing> is clear-cut the letters or lines.

Select <Smoothing> in the screen menu and select the suitable level from 1 ~ 5.

**NOTE**

- The “Smoothing” is disabled in the resolution 1024 x 768.
- Since the displayed image is enlarged, the blurred texts may not be necessarily lost completely.



## 6. To Set the Brightness of the screen.

→  Use the <Brightness> adjustment.

The brightness of the entire screen is controlled by changing the brightness of the backlight.

Select < Brightness > in the screen menu and adjust by using the Up and Down Buttons.

### **NOTE**

- Directly pressing the Up and Down Buttons also adjusts the brightness. Press the Enter Button to save and exit the settings after the adjustment.

## 4-2. Color Adjustment



The <Color> menu in the ScreenManager enables to change the color of the screen. By using the <Color Mode>, the adjustment mode can be selected from <Custom mode> (to adjust the color settings according to your preference) and <sRGB> mode.





**In the analog input, perform the “Range Adjustment” (p.22) before making the color adjustments.**

### NOTE

- Allow the LCD monitor to stabilize for at least 20 minutes before making image adjustments. (Allow the monitor to warm up for at least 20 minutes before making adjustments.)
- Performing the <Reset> of the <Color> menu returns the color settings to the default settings
- The values shown in percentages represent the current level within the specific adjustment. They are available only as a reference tool. (To create an uniform white or black screen, the percentages for each will probably not be the same.)

### Adjustment Contents

Menu	Color Mode		Function Descriptions	Adjustable range
	Custom	sRGB		
Brightness 	√	√	To set the brightness of the screen	0 ~ 100%
Temperature (p.37) 	√	-	To set the color temperature	4,000 ~ 10,000 K in 500 K increments (including 9,300 K). Default setting is off (normal white)
<b>NOTE</b>				
<ul style="list-style-type: none"> <li>• The values shown in the Kelvin are available only as a reference tool.</li> <li>• Setting the temperature under 4,000 K or over 10,000 K invalidates the color temperature setting. (The color temperature's setting turns “OFF”.)</li> </ul>				
Gamma (p.37) 	√	-	To set the gamma value	1.8 ~ 2.6
<b>NOTE</b>				
<ul style="list-style-type: none"> <li>• If setting the gamma value, the using the monitor in the digital signal input is recommended. If using the monitor in the analog input signal, set the gamma value from 1.8 to 2.2.</li> </ul>				

Menu	Color Mode		Function Descriptions	Adjustable range
	Custom	sRGB		
Saturation 	√	-	To change the saturation	-128 ~ 127 Setting the minimum level (-128) turns the image to the monochrome.
<b>NOTE</b>				
• The <Saturation> adjustment may cause undisplayable color tone.				
Hue 	√	-	To change the flesh color, etc.	-32 ~ 32
<b>NOTE</b>				
• The <Hue> adjustment may cause undisplayable color tone.				
Gain (p.37) 	√	-	To change each color (red, green and blue)	0 ~ 100% By adjusting the red, green and blue color tones for each mode, custom colors can be defined. Display a white or gray background image and adjust the <Gain>.
<b>NOTE</b>				
• The values shown in the percentage are available only as a reference tool.				
• Setting the <Temperature> (p.37) invalidates the <Gain> adjustment. <Gain> setting returns to the default.				
Reset 	√	-	To return the color settings to the default settings	Select the "Reset".

## 4-3. Power-save Setup

The <PowerManager> menu in the ScreenManager enables to set the power-save setup.

### NOTE

- Do your part to conserve energy, turn off the monitor when you are finished using it. Disconnecting the monitor from the power supply is recommended to save energy completely.

### Analog Input

This monitor complies with the VESA DPMS (p.38).

#### [Procedure]

- (1) Set the PC's power saving settings.
- (2) Select "VESA DPMS" from the <PowerManager> menu.

#### [Power saving system]

PC		Monitor	Power Indicator
Operation		Operation	Blue
Power saving	STAND-BY SUSPEND OFF	Power saving	Yellow

#### [Power Resumption Procedure]

Operate the mouse or keyboard to return to a normal screen.

### Digital Input

This monitor complies with the DVI DMPM (p.37).

#### [Procedure]

- (1) Set the PC's power saving settings.
- (2) Select "DVI DMPM" from the < PowerManager > menu.

#### [Power saving system]

PC		Monitor	Power Indicator
Operation		Operation	Blue
Power saving		Power saving	Yellow
Off mode		Power saving <sup>*1</sup>	Flashing yellow (2 times for each)

<sup>\*1</sup> Power saving through the PC's off mode is only supported when "Manual" is selected on the ScreenManager's <Input Signal>.

#### [Power Resumption Procedure]

Operate the mouse or keyboard to return to a normal screen from the Power save mode of the PC.

Power on the PC to return a normal screen from the Off mode of the PC.

## Power save for speaker

When the monitor is in the power-saving mode, sound of speaker also erases simultaneously can be performed.

### [Procedure]

- (1) Set the PC's power saving settings.
- (2) Select <Sound>.
- (3) Select "Disable". ("Enable" is selected to leave sound.)

# 5. ATTACHING A STAND

The LCD monitor can be used with other stand by removing the tilt stand and attaching the stand to the LCD monitor.

## NOTE

- When attaching an arm or stand, follow the instructions of their user's manual.
- When using another manufacturer's arm or stand, confirm the following in advance and select one conforming to the VESA standard.
  - Clearance between the screw holes: 100 mm x 100 mm
  - Thickness of plate: 2.6 mm
  - Strong enough to support weight of the monitor unit (except the stand) and attachments such as cables.
- Attach an arm or stand to meet the following tilt angles of the monitor.
  - Up 45 degrees, down 0 degrees (Within operating range)
- Please connect cables after attaching a stand.

## Setup Procedure

1. Lay the LCD monitor down. Do not scratch the panel.
2. Remove the tilt stand by loosening the screws (2 pcs of M4 x 10 mm).
3. Attach a stand to the LCD monitor securely.

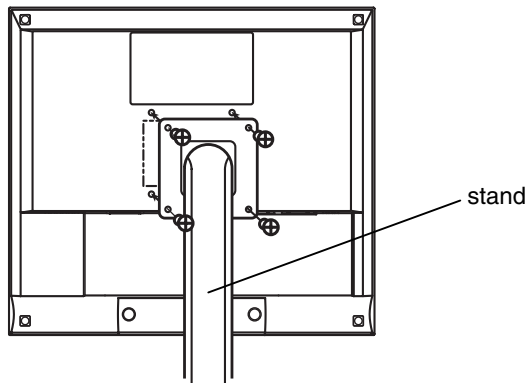



4 Mounting Screws (enclosed): M4 x 12 mm

# 6. TROUBLESHOOTING

If a problem persists even after applying the suggested remedies, contact an EIZO dealer.

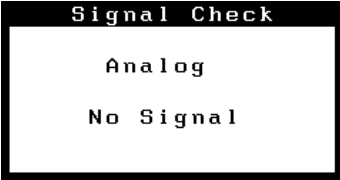
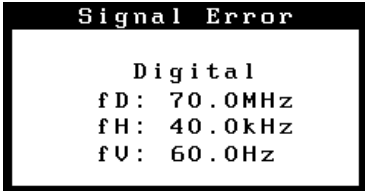
- No picture problems : See No.1 ~ No.2
- Imaging problems : See No.3 ~ No.9
- Other problems : See No.10 ~ No.13
- Touch Panel Problems: See No. 14 ~ No.17

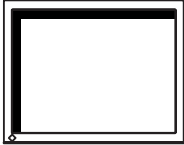
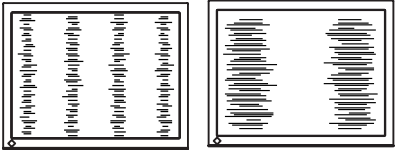
Problems	Points to check with possible solutions
<p><b>1. No picture</b></p> <ul style="list-style-type: none"> <li>• Indicator status: Off</li> </ul>	<ul style="list-style-type: none"> <li><input type="checkbox"/> Check that the power cord is correctly connected. If the problem persists, turn off the monitor power for a few minutes, then turn it back on and try again.</li> </ul>
<ul style="list-style-type: none"> <li>• Indicator status: Blue</li> <li>• Indicator status: Yellow</li> <li>• Indicator status: Flashing Yellow (twice for each)</li> </ul>	<ul style="list-style-type: none"> <li><input type="checkbox"/> Check the “Brightness” setting.</li> <li><input type="checkbox"/> Switch the signal input by pressing the Input Signal Selection Button on the front control panel.</li> <li><input type="checkbox"/> Try pressing a key on the keyboard, or clicking the mouse. (p.26)</li> <li><input type="checkbox"/> Try pressing the power of the computer.</li> </ul>
<p><b>2. The message below appears.</b></p> <ul style="list-style-type: none"> <li>• This message appears when no signal is input. (This is displayed for about 40 seconds.)</li> </ul> 	<p>These message appear when the signal is not inputted correctly, even if the monitor functions properly.</p> <ul style="list-style-type: none"> <li><input type="checkbox"/> When the image is displayed correctly after a short time, there is no problem with the monitor. (Some PCs do not output the signal soon after powering on.)</li> <li><input type="checkbox"/> Check that the PC is turned ON.</li> <li><input type="checkbox"/> Check that the signal cable is properly connected to the PC or graphics board.</li> <li><input type="checkbox"/> Switch the signal input by pressing the Input Signal Selection Button on the front control panel.</li> </ul>
<ul style="list-style-type: none"> <li>• The signal frequency is out of range. Error signal frequency will be displayed in red.</li> </ul> 	<ul style="list-style-type: none"> <li><input type="checkbox"/> Use the graphics board’s utility software to change the frequency setting. (Refer to the manual of the graphics board.)</li> </ul>

Problems	Points to check with possible solutions
<p><b>3. Display position is incorrect.</b></p> 	<ul style="list-style-type: none"> <li><input type="checkbox"/> Adjust the image position using the &lt;Position&gt; (p.22)</li> <li><input type="checkbox"/> The two display modes, VGA 720 x 400 (70 Hz) and 320 x 200 (70 Hz), have the same signal timings. Using this adjustment selects the appropriate display mode. (This function effects only when the resolution is VGA 720 x 400 (70 Hz) or 320 x 200 (70 Hz).)</li> <li><input type="checkbox"/> If the problem persists, use the graphics board's utility software to change the display position if available.</li> </ul>
<p><b>4. Vertical bars of distortion appear.</b></p> 	<ul style="list-style-type: none"> <li><input type="checkbox"/> Decrease the vertical bars using the &lt;Clock&gt;. (p.21)</li> </ul>
<p><b>5. Horizontal bars of distortion appear.</b></p> 	<ul style="list-style-type: none"> <li><input type="checkbox"/> Decrease the horizontal bars using the &lt;Phase&gt;. (p.21)</li> </ul>
<p><b>6. Letters and lines appear blurred.</b></p>	<ul style="list-style-type: none"> <li><input type="checkbox"/> Switch the &lt;Smoothing&gt; mode. (p.22)</li> </ul>
<p><b>7. The screen is too bright or too dark.</b></p>	<ul style="list-style-type: none"> <li><input type="checkbox"/> Adjust the &lt;Brightness&gt; . (The backlight of the LCD monitor has a fixed life span. When the screen becomes dark or begins to flicker, please consult your dealer.)</li> </ul>
<p><b>8. Afterimages appear.</b></p>	<ul style="list-style-type: none"> <li><input type="checkbox"/> Do you use the screen saver or timer when displaying the same image for extended periods of time?</li> <li><input type="checkbox"/> Afterimages are particular to LCD monitors. Avoid displaying the same image for extended periods of time.</li> </ul>
<p><b>9. The screen has defective pixels (e.g. slightly light or dark).</b></p>	<ul style="list-style-type: none"> <li><input type="checkbox"/> This is due to the characteristics of the panel itself, and not the LCD product.</li> </ul>



Problems	Points to check with possible solutions
<b>10.The &lt;Smoothing&gt; cannot be selected.</b>	<input type="checkbox"/> <Smoothing> is disabled when the screen is displayed in the 1024 x768.
<b>11.The Main menu of ScreenManager does not operate.</b>	<input type="checkbox"/> The adjustment lock is probably on. To unlock: switch the LCD monitor off. Then, while pressing the Auto Adjustment Button switch, the power on. (p.18)
<b>12.The Auto Adjustment Button does not operate.</b>	<input type="checkbox"/> The adjustment lock is probably on. To unlock: switch the LCD monitor off. Then, while pressing the Auto Adjustment Button switch, the power on. (p.18) <input type="checkbox"/> The Auto sizing function is intended for use on the AT-compatible PC running Windows. It may not work properly in either of the following cases. <ul style="list-style-type: none"> <li>• When running an AT-compatible PC on MS-DOS (Not windows).</li> <li>• The background color for the “wall paper” or “desktop” pattern is set to black.</li> </ul> <input type="checkbox"/> Some signals from a graphics board may not function properly.
<b>13.The signal Selection Button does not operate.</b>	<input type="checkbox"/> The computer with digital may be in the off mode (power indicator flashing yellow). Try to press the monitor’s power switch and press the Input Signal Selection Button again.

- Touch Panel problems

Problems	Points to check with possible solutions
<b>14.Cursor is jittery. / Drawing lines are not straight and smooth.</b>	<input type="checkbox"/> The influence of metal may cause jittery cursor. <input type="checkbox"/> When multiple monitors are placed close to each other, leave space between monitors.
<b>15.Cursor position is not correct. / Cursor jumps.</b>	<input type="checkbox"/> When cursor position is incorrect or cursor jumps, turn off and on the monitor. If the symptom is not improved, perform the calibration on the monitor. <ul style="list-style-type: none"> <li>• Do not touch the screen while turning on the PC and the monitor. Touch the screen one second later after appearing the image.</li> <li>• Changing the position or angle of the monitor will cause cursor jump.</li> </ul> <input type="checkbox"/> The drawing touch and dragging the finger on the touch panel to draw the picture may cause incorrect cursor position. <input type="checkbox"/> Keep metals away from the panel surface. <input type="checkbox"/> Touch with one finger only. Keep other fingers away from the touch screen. Do not rest the hand in the monitor or bezel while touching the screen. <input type="checkbox"/> The spray for preventing static electricity may influences the sensibility of the touch panel. Do not use it on cleaning.
<b>16.Continuous touch sound./ Much time requirement for executing touch screen calibration or cursor stabilization.</b>	<input type="checkbox"/> Check the baud rate for the touch panel on TouchWare. The baud rate of 1200 bps may cause continuous touch sound or much time requirement for executing touch screen calibration or cursor stabilization.
<b>17.No touch sound.</b>	<input type="checkbox"/> The touch sound may not be output from the external line out of the PC depending on the hardware configuration.

---

# 7. CLEANING

Periodic cleaning is recommended to keep the monitor looking new and to prolong its operation lifetime.

**NOTE**

- Chemicals such as alcohol and antiseptic solution may cause gloss variation, tarnishing, and fading of the cabinet or panel, and also quality deterioration of the image.
- Never use any thinner, benzene, wax, and abrasive cleaner, which may damage the cabinet or panel.
- Do not allow liquid to enter the clearance between the panel and the panel frame.
- The optional ScreenCleaner is recommended for cleaning the panel surface.

If necessary, the stains on the cabinet and panel surface can be removed by moistening part of a soft cloth with water.

# 8. SPECIFICATIONS

LCD Panel		38 cm (15.0 inch), TFT color LCD panel with Anti-Glare Hard Coating, Viewing Angle: H: 170°, V: 170° Response Time: approx. 55 ms
Dot Pitch		0.297 mm
Horizontal Scan Frequency		Analog: 24 ~ 61 kHz (Automatic) Digital: 31 ~ 49 kHz
Vertical Scan Frequency		Analog: 55 ~ 75 Hz (Automatic) Digital: 59 ~ 61 Hz, (VGA Text : 70Hz)
Resolution		0.8 M pixels (1024 dots x 768 lines)
Dot Clock (Max.)		Analog: 79 MHz Digital: 66 MHz
Display Colors		16 million colors (max.)
Display Area		304.1 mm (H) x 228.1 mm (V) (11.9" (H) x 8.9" (V)) (Viewable image size: 381 mm (15.0"))
Touch Panel	OS	Microsoft Windows 2000 Service Pack 4 Microsoft Windows XP Service Pack 3 (32 bit) Microsoft Windows Vista Service Pack 1 (32 bit) (Not compatible with MacOS)
	Communication protocol	RS-232C serial
	Detective method	Analog capacitive technology, finger touch
Power Supply		100-120/200-240 VAC±10%, 50/60 Hz, 0.7-0.6 A/0.4-0.35 A
Power Consumption		Max.: 40 W (with speaker) Power Saving Mode: Less than 3 W
Input Connector		D-Sub mini 15 pin, DVI-D
Analog Input Signal (Sync)		Separate, TTL, Positive/Negative
Analog Input Signal (Video)		0.7Vp-p/75Ω Positive
Input Signal (Digital)		TMDS (Single Link)
Signal registration		Analog: 45 (Factory preset: 12)
Plug & Play		VESA DDC 2B
Amplifier Output (max.)		1 W + 1 W
Line input		Input impedance 11 kΩ (min.) Input sensitivity: 500 mV
Dimensions	with stand	346 mm (W) x 369 mm (H) x 157 mm (D) (13.4"(W) x 14.5"(H) x 6.2"(D))
	without stand	346 mm (W) x 301 mm (H) x 54.5 mm (D) (13.4"(W) x 11.6"(H) x 1.9"(D))
Weight	with stand	5.0 kg (11.2 lbs.)
	without stand	4.1 kg (9.0 lbs.)

Environment conditions	Temperature	Operating: 0 °C ~ 35 °C (32 °F ~ 95 ° F) Transportation/Storage: -20 °C ~ 60 °C (-4 °F ~ 140 ° F)
	Humidity	30% to 80% R.H. Non-condensing
	Pressure	860 to 1,060 hPa
Certifications and Standards 100-120 VAC 200-240 VAC		CB, NRTL/C-TÜV, FCC-B CE(93/42/EEC), CB, TÜV Rheinland/GM
Classification of Equipment		Type of protection against electric shock : Class I EMC class : EN60601-1-2:2007 Group1 Class B Classification of medical device (MDD 93/42/EEC) : Class I Mode of operation : Continuous IP Class : IPX0

### Default settings

	Analog input	Digital input
Brightness	100%	
Smoothing	3	
Temperature	Off (normal white: approx. 6500 K)	
PowerManager	VESA DPMS	DVI DMPM
Input Signal	Auto	
Off Timer	Disable	
Language	English	

### Optional

Touch Panel Pointer	TP1
---------------------	-----

### Dimensions

### Unit mm (inches)

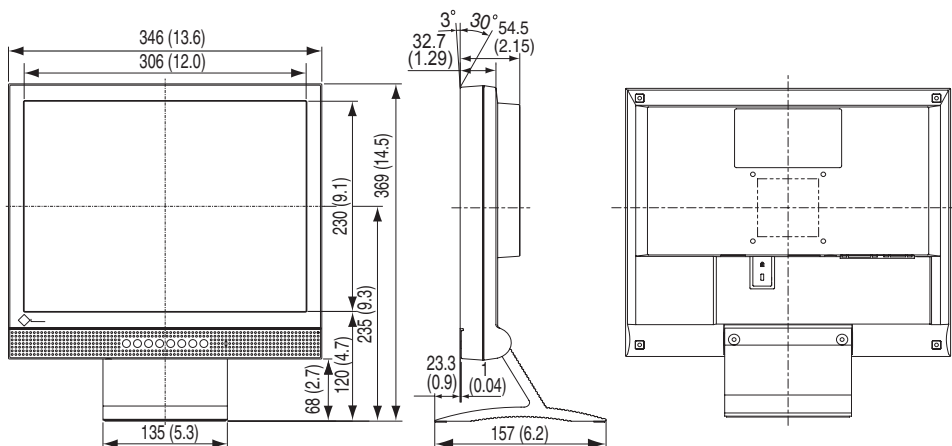

## Pin Assignment

### D-Sub mini 15 pin connector

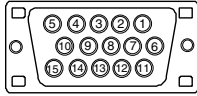

Pin No.	Signal	Pin No.	Signal	Pin No.	Signal
1	Red video	6	Red ground	11	Ground Shorted
2	Green video	7	Green ground	12	Data (SDA)
3	Blue video	8	Blue ground	13	H. Sync
4	Ground	9	No pin	14	V. Sync
5	No pin	10	Ground Shorted	15	Clock (SCL)

### DVI-D Connector

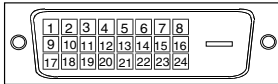

Pin No.	Signal	Pin No.	Signal	Pin No.	Signal
1	TMDS Data2-	9	TMDS Data1-	17	TMDS Data0-
2	TMDS Data2+	10	TMDS Data1+	18	TMDS Data0+
3	TMDS Data2/4 Shield	11	TMDS Data1/3 Shield	19	TMDS Data0/5 Shield
4	NC*	12	NC	20	NC
5	NC	13	NC	21	NC
6	DDC Clock (SCL)	14	+5V Power	22	TMDS Clock shield
7	DDC Data (SDA)	15	Ground (For +5V)	23	TMDS Clock+
8	Analog Vertical Sync	16	Hot Plug Detect	24	TMDS Clock-

(\*NC: No Connection)

### RS-232C Port (Mini DIN 6 pin)



Pin No.	Signal
1	RXD
2	RTS
3	CTS
4	GND
5	TXD
6	GND

---

# 9. GLOSSARY

## Clock

With the analog input signal display, the analog signal is converted to a digital signal by the LCD circuitry. To convert the signal correctly, the LCD monitor needs to produce the same number clock pulse as the dot clock of the graphics system. When the clock pulse is not correctly set, some vertical bars of distortion are displayed on the screen.

## Color Temperature (Temperature)

Color Temperature is a method to measure the white color tone, generally indicated in degrees Kelvin. At high temperatures the white tone appears somewhat blue, while at lower temperatures it appears somewhat red. Computer monitors generally give best performance at high temperature settings.

5,000 K: Slightly reddish white.

6,500 K: Warm-white tone, similar to white paper or daylight.

9,300 K: Slightly bluish white.

## DVI

(Digital Visual Interface)

A digital flat panel interface. DVI can transmit digital data from the PC directly without loss with the signal transition method “TMDS”.

There are two kinds of DVI connectors. One is DVI-D connector for digital signal input only. The other is DVI-I connector for both digital and analog signal inputs.

## DVI DMPM

(DVI Digital Monitor Power Management)

The Power management system for the digital interface. The “Monitor ON” status (operation mode) and the “Active Off” status (power-saving mode) are indispensable for the DVI-DMPM as the monitor’s power mode.

## Gain Adjustment

Adjusts each color parameter for red, green and blue. The color of the LCD monitor is displayed through the color filter of the LCD panel. Red, green and blue are the three primary colors. The colors on the monitor are displayed by combining these three colors. The color tone can change by adjusting the illumination amount passed through each color’s filter.

## Gamma

Generally, the relationship that the light intensity values of a monitor change nonlinearly to the input signal level is called “Gamma Characteristic”. On the monitor, low gamma values display the whitish images and high gamma values display the high contrast images.

### **Phase**

The phase adjustment decides the sampling timing point for converting the analog input signal to a digital signal. Adjusting the phase after the clock adjustment will produce a clear screen.

### **Range Adjustment**

The Range Adjustment controls the level of output signal range to display the whole color gradation.

### **Resolution**

The LCD panel consists of a fixed number of pixel elements which are illuminated to form the screen image. The display panel of this monitor consists of 1024 horizontal pixels and 768 vertical pixels. At a resolution of 1024 x 768, images are displayed as a full screen (1:1).

### **sRGB (Standard RGB)**

“International Standard for Red, Green, and Blue color space”

A color space was defined with the aim of the color matching between applications and hardware devices, such as monitors, scanners, printers and digital cameras. As a standard default space, sRGB allows Internet users to closely match colors.

### **TMDS**

(Transition Minimized Differential Signaling)

A signal transition method for the digital interface.

### **VESA DPMS**

(Video Electronics Standards Association - Display Power Management Signaling)

The acronym VESA stands for “Video Electronics Standards Association”, and DPMS stands for “Display Power Management Signaling.” DPMS is a communication standard that PCs and graphics boards use to implement power savings on the monitor side.



---

# APPENDIX/ANHANG/ANNEXE

## Preset Timing Chart for Analog input Timing-Übersichten für Analog Eingang Synchronisation des Signaux pour Analog numerique

Based on the signal diagram shown below 12 factory presets have been registered in the monitor's microprocessor.

Der integrierte Mikroprozessor des Monitors unterstützt 12 werkseitige Standardeinstellungen (siehe hierzu die nachfolgenden Diagramme).

12 signaux ont été enregistrés en usine dans le microprocesseur du moniteur, conformément au diagramme de synchronisation ci-dessous.

Mode	Dot Clock MHz	Sync Polarity		Frequencies	
		H	V	H kHz	V Hz
VGA Mode13 320 × 200	25.2	Nega.	Nega.	31.47	70.09
VGA 640 × 480	25.2	Nega.	Nega.	31.47	59.94
VGA 720 × 400	28.3	Nega.	Posi.	31.47	70.09
VESA 640 × 480	31.5	Nega.	Nega.	37.86	72.81
VESA 640 × 480	31.5	Nega.	Nega.	37.50	75.00
VESA 800 × 600	36.0	Posi.	Posi.	35.16	56.25
VESA 800 × 600	40.0	Posi.	Posi.	37.88	60.32
VESA 800 × 600	50.0	Posi.	Posi.	48.08	72.19
VESA 800 × 600	49.5	Posi.	Posi.	46.88	75.00
VESA 1024 × 768	65.0	Nega.	Nega.	48.36	60.00
VESA 1024 × 768	75.0	Nega.	Nega.	56.48	70.07
VESA 1024 × 768	78.8	Posi.	Posi.	60.02	75.03

# EMC Information

Essential performance of FlexScan L362T is to display images and operate functions normally.



## CAUTION

**The FlexScan L362T requires special precautions regarding EMC and need to be installed, put into service and used according to the following information.**

**Do not use any cables other than the cables that provided or specified by us.  
Using other cables may cause the increase of emission or decrease of immunity.**

**Do not put any portable and mobile RF communications equipment close to the FlexScan L362T.  
Doing so may affect the FlexScan L362T.**

**The FlexScan L362T should not be used adjacent to or stacked with other equipment. If adjacent or stacked use is necessary, the equipment or system should be observed to verify normal operation in the configuration in which it will be used.**

### Guidance and manufacturer's declaration - electromagnetic emissions

The FlexScan L362T is intended for use in the electromagnetic environment specified below.  
The customer or the user of the FlexScan L362T should assure that it is used in such an environment.

Emission test	Compliance	Electromagnetic environment - guidance
RF emissions EN55011	Group 1	The FlexScan L362T uses RF energy only for its internal function. Therefore, its RF emission are very low and are not likely to cause any interference in nearby electronic equipment.
RF emissions EN55011	Class B	The FlexScan L362T is suitable for use in all establishments, including domestic establishments and those directly connected to the public low-voltage power supply network that supplies buildings used for domestic purposes.
Harmonic emissions EN61000-3-2	Not applicable	
Voltage fluctuations / flicker emissions EN61000-3-3	Complies	

### Guidance and manufacturer's declaration - electromagnetic immunity

The FlexScan L362T is intended for use in the electromagnetic environment specified below.  
The customer or the user of the FlexScan L362T should assure that it is used in such an environment.

Immunity test	IEC60601 test level	Compliance level	Electromagnetic environment - guidance
Electrostatic discharge (ESD) EN61000-4-2	±6kV contact ±8kV air	±6kV contact ±8kV air	Floors should be wood, concrete or ceramic tile. If floors are covered with synthetic material, the relative humidity should be at least 30%.
Electrical fast transient / burst EN61000-4-4	±2kV for power supply lines ±1kV for input/output lines	±2kV for power supply lines ±1kV for input/output lines	Mains power quality should be that of a typical commercial or hospital environment.
Surge EN61000-4-5	±1kV line(s) to line(s) ±2kV line(s) to earth	±1kV line(s) to line(s) ±2kV line(s) to earth	Mains power quality should be that of a typical commercial or hospital environment.
Voltage dips, short interruptions and voltage variations on power supply input lines EN61000-4-11	<5% U <sub>T</sub> (>95% dip in U <sub>T</sub> ) for 0.5 cycle 40% U <sub>T</sub> (60% dip in U <sub>T</sub> ) for 5 cycles 70% U <sub>T</sub> (30% dip in U <sub>T</sub> ) for 25 cycles <5% U <sub>T</sub> (>95% dip in U <sub>T</sub> ) for 5sec	<5% U <sub>T</sub> (>95% dip in U <sub>T</sub> ) for 0.5 cycle 40% U <sub>T</sub> (60% dip in U <sub>T</sub> ) for 5 cycles 70% U <sub>T</sub> (30% dip in U <sub>T</sub> ) for 25 cycles <5% U <sub>T</sub> (>95% dip in U <sub>T</sub> ) for 5sec	Mains power quality should be that of a typical commercial or hospital environment. If the user of the FlexScan L362T requires continued operation during power mains interruptions, it is recommended that the FlexScan L362T be powered from an uninterruptible power supply or a battery.
Power frequency (50/60Hz) magnetic field EN61000-4-8	3A/m	3A/m	Power frequency magnetic fields should be at levels characteristic of a typical location in a typical commercial or hospital environment.

**NOTE** U<sub>T</sub> is the a.c. mains voltage prior to application of the test level.

**Guidance and manufacturer's declaration - electromagnetic immunity**

The FlexScan L362T is intended for use in the electromagnetic environment specified below. The customer or the user of the FlexScan L362T should assure that it is used in such an environment.

Immunity test	IEC60601 test level	Compliance level	Electromagnetic environment - guidance
Conducted RF EN61000-4-6  Radiated RF EN61000-4-3	3Vrms 150kHz to 80MHz  3V/m 80MHz to 2.5GHz	3V  3V/m	Portable and mobile RF communications equipment should be used no closer to any part of the FlexScan L362T, including cables, than the recommended separation distance calculated from the equation applicable to the frequency of the transmitter.  Recommended Separation distance $d = 1.2 \sqrt{P}$  $d = 1.2 \sqrt{P}$ , 80MHz to 800MHz $d = 2.3 \sqrt{P}$ , 800MHz to 2.5GHz  Where "P" is the maximum output power rating of the transmitter in watts (W) according to the transmitter manufacturer and "d" is the recommended separation distance in meters (m).  Field strengths from fixed RF transmitters, as determined by an electromagnetic site survey <sup>a</sup> , should be less than the compliance level in each frequency range <sup>b</sup> .  Interference may occur in the vicinity of equipment marked with the following symbol.  

NOTE 1 At 80 MHz and 800 MHz, the higher frequency range applies.

NOTE 2 These guidelines may not apply in all situations. Electromagnetic propagation is affected by absorption and reflection from structures, objects and people.

<sup>a</sup> Field strengths from fixed transmitters, such as base stations for radio (cellular/cordless) telephones and land mobile radios, amateur radio, AM and FM radio broadcast and TV broadcast cannot be predicted theoretically with accuracy. To assess the electromagnetic environment due to fixed RF transmitters, an electromagnetic site survey should be considered. If the measured field strength in the location in which the FlexScan L362T is used exceeds the applicable RF compliance level above, the FlexScan L362T should be observed to verify normal operation. If abnormal performance is observed, additional measures may be necessary, such as reorienting or relocating the FlexScan L362T.

<sup>b</sup> Over the frequency range 150 kHz to 80 MHz, field strengths should be less than 3 V/m.

## Recommended separation distances between portable and mobile RF communications equipment and the FlexScan L362T

The FlexScan L362T is intended for use in an electromagnetic environment in which radiated RF disturbances are controlled. The customer or the user of the FlexScan L362T can help prevent electromagnetic interference by maintaining a minimum distance between portable and mobile RF communications equipment (transmitters) and the FlexScan L362T as recommended below, according to the maximum output power of the communications equipment.

Rated maximum output power of transmitter  W	Separation distance according to frequency of transmitter m		
	150kHz to 80MHz $d = 1.2 \sqrt{P}$	80MHz to 800MHz $d = 1.2 \sqrt{P}$	800MHz to 2.5GHz $d = 2.3 \sqrt{P}$
0.01	0.12	0.12	0.23
0.1	0.38	0.38	0.73
1	1.2	1.2	2.3
10	3.8	3.8	7.3
100	12	12	23

For transmitters rated at a maximum output power not listed above, the recommended separation distance “d” in meters (m) can be estimated using the equation applicable to the frequency of the transmitter, where “P” is the maximum output power rating of the transmitter in watts (W) according to the transmitter manufacturer.

NOTE 1 At 80 MHz and 800 MHz, the separation distance for the higher frequency range applies.

NOTE 2 These guidelines may not apply in all situations. Electromagnetic propagation is affected by absorption and reflection from structures, objects and people.

Cable length		
Power Cord :	Accessory	2.0m
Signal Cable (MD-C87) :	Accessory	2.0m
Serial Cable (FD-C38) :	Accessory	1.8m
Signal Cable (FD-C39) :	Option	2.0m

### **Hinweise zur Auswahl des richtigen Schwenkarms für Ihren Monitor**

Dieser Monitor ist für Bildschirmarbeitsplätze vorgesehen. Wenn nicht der zum Standardzubehör gehörige Schwenkarm verwendet wird, muss statt dessen ein geeigneter anderer Schwenkarm installiert werden. Bei der Auswahl des Schwenkarms sind die nachstehenden Hinweise zu berücksichtigen:

Der Standfuß muß den nachfolgenden Anforderungen entsprechen:

- a) Der Standfuß muß eine ausreichende mechanische Stabilität zur Aufnahme des Gewichtes vom Bildschirmgerät und des spezifizierten Zubehörs besitzen. Das Gewicht des Bildschirmgerätes und des Zubehörs sind in der zugehörigen Bedienungsanleitung angegeben.
- b) Die Befestigung des Standfusses muß derart erfolgen, daß die oberste Zeile der Bildschirmanzeige nicht höher als die Augenhöhe eines Benutzers in sitzender Position ist.
- c) Im Fall eines stehenden Benutzers muß die Befestigung des Bildschirmgerätes derart erfolgen, daß die Höhe der Bildschirmmitte über dem Boden zwischen 135 – 150 cm beträgt.
- d) Der Standfuß muß die Möglichkeit zur Neigung des Bildschirmgerätes besitzen (max. vorwärts: 5°, min. nach hinten  $\geq$  5°).
- e) Der Standfuß muß die Möglichkeit zur Drehung des Bildschirmgerätes besitzen (max.  $\pm$  180°). Der maximale Kraftaufwand dafür muß weniger als 100 N betragen.
- f) Der Standfuß muß in der Stellung verharren, in die er manuell bewegt wurde.
- g) Der Glanzgrad des Standfusses muß weniger als 20 Glanzeinheiten betragen (seidenmatt).
- h) Der Standfuß mit Bildschirmgerät muß bei einer Neigung von bis zu 10° aus der normalen aufrechten Position kippsicher sein.

**Recycle Auskunft**

Die Rücknahme dieses Produktes nach Nutzungsende übernimmt EIZO in Deutschland zusammen mit dem Partner eds-r gmbh rucknahmesysteme. Dort werden die Geräte in ihre Bestandteile zerlegt, die dann der Wiederverwertung zugeführt werden. Um einen Abholtermin zu vereinbaren und die aktuellen Kosten zu erfahren, benutzen Sie bitte folgende Rufnummer: 02153-73 35 00. Weitere Informationen finden Sie auch unter der Internet-Adresse: [www.eizo.de](http://www.eizo.de).

**Recycling Information for customers in Switzerland:**

All recycling information is placed in the SWICO's website.  
<http://www.swico.ch>

**Recycling-Information für Kunden in der Schweiz:**

Alle Informationen zum Thema Recycling finden Sie auf der Homepage des Branchenverbandes SWICO.  
<http://www.swico.ch>

**Renseignements de recyclage pour les clients en Suisse:**

Vous trouvez tous les renseignements pour le sujet de recyclage sur la page WEB de l'UNION DE BRAN CHE SWICO.  
<http://www.swico.ch>

**Recycling Information for customers in USA:**

All recycling information is placed in the EIZO Nanao Technologies, Inc's website.  
<http://www.eizo.com/>

**Återvinnings information för kunder i Sverige:**

All information om återvinning finns på Eizo Europe AB:s hemsida:  
[www.eizo.se](http://www.eizo.se)



## **EIZO NANA O CORPORATION**

153 Shimokashiwano, Hakusan, Ishikawa 924-8566 Japan  
Phone: +81 76 277 6792 Fax: +81 76 277 6793

## **EIZO GmbH**

Siemensallee 84, 76187 Karlsruhe, Germany  
Phone: +49 721 20321 0 Fax: +49 721 20321 471

## **艺卓显像技术(苏州)有限公司**

中国苏州市苏州工业园区展业路8号中新科技工业坊5B  
Phone: +86 512 6252 0100 Fax: +86 512 6252 1508



<http://www.eizo.com>

6th Edition-March, 2012 Printed in Japan.

Copyright © 2003-2012 EIZO NANA O CORPORATION All rights reserved.

05C21411F4  
(U.M-FT1566-EU)