



Setup Manual

DuraVision® FDX1004T

Touch Panel Color LCD Monitor







Important

Carefully read this Setup Manual and User's Manual (downloaded from the website) before use to use the monitor correctly. Please retain this manual for future reference.

- Refer to the "User's Manual" for information on the setting / adjustment of the monitor.
- You can check the latest product information, including the Setup Manual, from our web site.
www.eizoglobal.com

SAFETY SYMBOLS

This manual and this product use the safety symbols below. They denote critical information. Please read them carefully.

 WARNING	Failure to abide by the information in a WARNING may result in serious injury and can be life threatening.
 CAUTION	Failure to abide by the information in a CAUTION may result in moderate injury and/or property or product damage.
	Indicates a warning or caution. For example,  indicates an "electrical shock" hazard.
	Indicates a prohibited action. For example,  means "Do not disassemble".

This product has been adjusted specifically for use in the region to which it was originally shipped.

If operated outside this region, the product may not perform as stated in the specifications.

No part of this manual may be reproduced, stored in a retrieval system, or transmitted, in any form or by any means, electronic, mechanical, or otherwise, without the prior written permission of EIZO Corporation.

EIZO Corporation is under no obligation to hold any submitted material or information confidential unless prior arrangements are made pursuant to EIZO Corporation's receipt of said information. Although every effort has been made to ensure that this manual provides up-to-date information, please note that EIZO product specifications are subject to change without notice.

PRECAUTIONS

Important

This product has been adjusted specifically for use in the region to which it was originally shipped. If operated outside this region, the product may not perform as stated in the specifications.

To personal safety and proper maintenance, please read carefully the "PRECAUTIONS" section and the caution statements on the monitor.



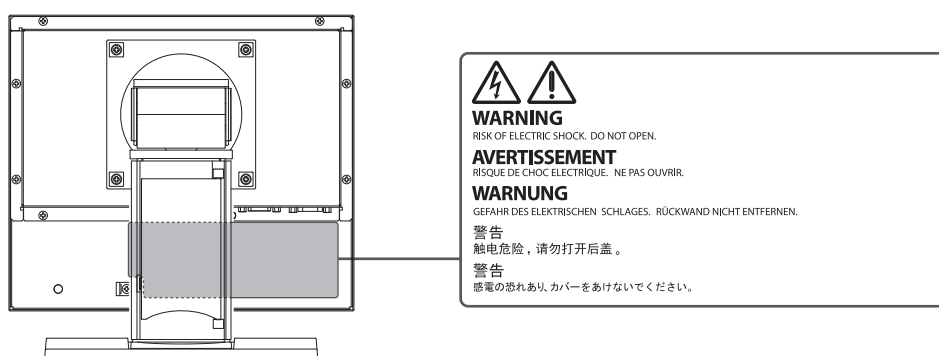



Location of Caution Statement







Symbols on the unit











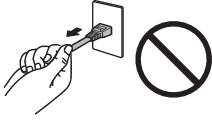

Symbol	This symbol indicates
	Power button: Press to turn the monitor's power on or off.
	Direct current
	Alerting electrical shock hazard
	CAUTION: See SAFETY SYMBOLS [▶ 2]
	WEEE marking: Product must be disposed of separately; materials may be recycled.
	CE marking: EU conformity mark in accordance with the provisions of Council Directive and/or Regulation (EU).
	Mark signifying compliance with UK regulations

WARNING

 WARNING
<p>If the unit begins to emit smoke, smells like something is burning, or makes strange noises, disconnect all power connections immediately and contact your EIZO representative for advice.</p> <p>Attempting to use a malfunctioning unit may result in fire, electrical shock, or equipment damage.</p>
 WARNING
<p>Do not disassemble or modify the unit.</p> <p>Opening the cabinet may result in electrical shock or burn by high-voltage or high-temperature parts. Modifying the unit may result in fire or electrical shock.</p>

 WARNING
<p>Refer all servicing to qualified service personnel.</p> <p>Do not attempt to service this product yourself as opening or removing covers may result in fire, electrical shock, or equipment damage.</p>
 WARNING
<p>Keep foreign objects or liquids away from the unit.</p> <p>Metal parts, flammable materials, or liquids accidentally falling into the cabinet may result in fire, electrical shock, or equipment damage.</p> <p>If an object or liquid falls/spills into the cabinet, unplug the unit immediately. Have the unit checked by a qualified service engineer before using it again.</p>

 WARNING
<p>Place the unit at a sturdy and stable place.</p> <p>A unit placed on an inadequate surface may fall and result in injury.</p> <p>If the unit falls, disconnect the power immediately and ask your local EIZO representative for advice. Do not continue using a damaged unit. Using a damaged unit may result in fire or electrical shock.</p>

 WARNING
<p>Use the unit in an appropriate location.</p> <p>Otherwise, fire, electrical shock, or equipment damage may result.</p> <ul style="list-style-type: none"> • Do not place outdoors. • Do not place in any form of transportation (ships, aircraft, trains, automobiles, etc.). • Do not place in dusty or humid environments. • Do not place in locations where water may be splashed on the screen (bathrooms, kitchens, etc.) • Do not place in locations where steam comes in direct contact with the screen. • Do not place near heat generating devices or humidifiers. • Do not place in locations where the product is subject to direct sunlight. • Do not place in environments with inflammable gas. • Do not place in environments with corrosive gases (such as sulfur dioxide, hydrogen sulfide, nitrogen dioxide, chlorine, ammonia, and ozone). • Do not place in environments with dust, components that accelerate corrosion in the atmosphere (such as sodium chloride and sulfur), conductive metals, and so on. 
 WARNING
<p>Keep the plastic packing bags away from babies and children.</p> <p>The plastic packing bags may cause suffocation.</p>
 WARNING
<p>If using the AC power connector, make sure the power cord meets the following requirements.</p> <p>This product does not include a power cord. Please prepare separately a power cord which meets the requirements.</p> <p>* The power cord must be compliance with the mandatory standards of the country and region in which this product is to be used.</p> <ul style="list-style-type: none"> • For Europe: The power cord set has rated value of at least AC 250V~10A and has cord type H05VV-F, GTCE-3, 0.75mm². • For USA: The power cord set has rated value of at least AC 125V~10A and has cord type SVT,3/18AWG (0.75mm²). • For China: The power cord set has rated value of at least AC 250V~10A and has cord type "配60227 IEC53 3×1 平方毫米"
 WARNING
<p>Use the enclosed AC adapter.</p> <p>The enclosed AC adapter is for use with this product only. Do not use the AC adapter with other equipment. Do not use an AC adapter designed for other devices with this product.</p> <p>Connecting to power sources that do not match the power ratings of the AC adapter may result in fire or electrical shock.</p>

PRECAUTIONS

 WARNING	
<p>To disconnect the power cord or adapter power cable, grasp the plug firmly and pull.</p> <p>Tugging on the cord or cable may damage it and result in fire or electrical shock.</p>	
 	
 WARNING	
<p>The equipment must be connected to a grounded main outlet.</p> <p>Failure to do so may result in fire or electric shock.</p>	
 WARNING	
<p>Use the correct voltage.</p> <ul style="list-style-type: none">• The unit is designed for use with a specific voltage only. Connection to another voltage than specified in this "Instructions for Use" may cause fire, electric shock, or equipment damage. Power supply: 100-240 Vac 50/60 Hz• Do not overload your power circuit, as this may result in fire or electric shock.	
 WARNING	
<p>Handle the power cord and AC adapter with care.</p> <p>Do not place heavy objects on the power cord or AC adapter, or pull or tie the power cord. Using a damaged power cord or AC adapter may result in fire or electrical shock.</p>	
 WARNING	
<p>Never touch the power plug, AC adapter or power cord during a thunderstorm.</p> <p>Touching them may result in electrical shock.</p>	
 WARNING	
<p>When attaching an arm stand, please refer to the User's Manual of the arm stand and install the unit securely.</p> <p>Otherwise, the unit may become detached, resulting in injury and/or equipment damage.</p> <p>Before installation, make sure that desks, walls, or any other installation surface has adequate mechanical strength.</p> <p>If the unit falls, disconnect the power immediately and ask your local EIZO representative for advice. Do not continue using a damaged unit. Using a damaged unit may result in fire or electrical shock.</p> <p>When reattaching the tilt stand, please use the same screws and tighten them securely.</p>	
 WARNING	
<p>Do not touch a damaged LCD panel directly with bare hands.</p> <p>If any part of your skin comes in direct contact with the panel, wash thoroughly.</p> <p>If liquid crystal enters your eyes or mouth, immediately flush with large amounts of water and seek medical attention. Otherwise, you may have a toxic reaction.</p>	



WARNING

For installment in high locations, ask for the help of a professional.

When installing the monitor in a high location, there is a risk of the product or its parts falling and causing injury. Ask for help from us or from a professional who specializes in construction work when installing the monitor, including an inspection of the product for any damage or deformities both before and after installing the monitor.

CAUTION

CAUTION

Disconnect cables and remove accessories when moving the unit.

Otherwise, the cables or accessories may become detached when moving, resulting in injury.

CAUTION

Carry or place the unit according to the correct specified methods.

- When moving the product, hold the bottom of the monitor firmly.
- Monitors of size 30 inches and above are heavy. When unpacking and/or carrying the monitor, ensure at least two people are utilized.
- If your device model has a handle on the back of the monitor, grasp and firmly hold the bottom and handle of the monitor.

Dropping the unit may result in injury or equipment damage.

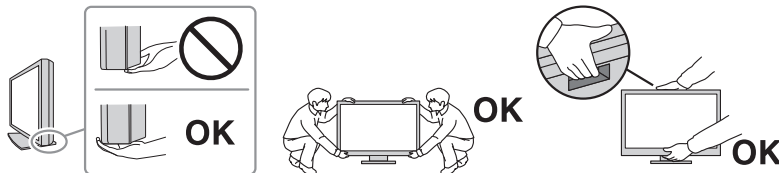

CAUTION

Exercise care not to pinch your hands.

If you suddenly apply force to the monitor to adjust its height or angle, your hands may be pinched and injured.

CAUTION

Do not block the ventilation slots on the cabinet.

- Do not place any objects on the ventilation slots.
- Do not install the unit in a place with poor ventilation or inadequate space.
- Do not use the unit laid down or upside down.

Blocking the ventilation slots prevents proper airflow and may result in fire, electrical shock, or equipment damage.

CAUTION

Do not touch the power plug or AC adapter with wet hands.











Touching them may result in electrical shock.



CAUTION

Do not place any objects around the power plug.

This is to facilitate disconnecting the power plug in case of a problem to avoid fire or electrical shock.

 CAUTION	
<p>The AC adapter becomes hot during use.</p> <ul style="list-style-type: none"> • Do not touch the AC adapter while it is energized. Touching it may cause a low temperature burn. • Do not cover or place anything on top of the AC adapter. Do not place the AC adapter on top of things that trap heat such as carpets, blankets, etc. Keep the AC adapter away from direct sunlight and heat sources. Failure to do so may result in fire. • Before moving the monitor, be sure to turn off the power switch, disconnect the power plug from the power outlet, and wait until it has cooled completely. 	
 CAUTION	
<p>Do not suspend the AC adapter in midair.</p> <p>Using the adapter while it is hanging suspended may result in fire or electrical shock.</p>	
 CAUTION	
<p>Do not place the AC adapter in a vertical orientation.</p> <p>Otherwise, dust or water may enter the adapter and may result in fire or electrical shock.</p>	
 CAUTION	
<p>Do not subject the unit and the AC adapter to any impact due to dropping them or any other causes.</p> <p>Using the adapter after it has been subjected to impact may result in fire or electrical shock.</p>	
 CAUTION	
<p>Periodically clean the area around the power plug and the ventilation slot of the monitor and the AC adapter.</p> <p>Dust, water, or oil adhered to this area may result in fire.</p>	
 CAUTION	
<p>Unplug the unit before cleaning it.</p> <p>Cleaning the unit while it is plugged into a power outlet may result in electrical shock.</p>	
 CAUTION	
<p>If you plan to leave the unit unused for an extended period of time, disconnect the power plug from the wall socket after turning off the power switch for the safety and the power saving.</p>	
 CAUTION	
<p>Dispose of this product in accordance with the laws of the locality or country of residence.</p>	

About This Product

About the Usage of This Product

- Aside from creating documents, viewing multimedia content, and other general purposes, this product is also suited to the dedicated usages such as operation of terminal equipment.
- This product has been adjusted specifically for use in the region to which it was originally shipped. If the product is used outside the region, it may not operate as specified in the specifications.
- This product may not be covered by warranty for uses other than those described in this manual.
- The specifications noted in this manual are only applicable when the following are used:
 - Signal cables specified by us
- Only use optional products manufactured or specified by us with this product.

About the LCD Panel

- It takes about 30 minutes (under our measurement conditions) for the monitor display to stabilize. Please wait 30 minutes or more after the monitor power has been turned on, and then adjust the monitor.
- Monitors should be set to a lower brightness to prevent a loss in the screen quality caused by long-term use and to maintain stable use.
- When the screen image is changed after displaying the same image for extended periods of time, an afterimage may remain. Use the screensaver or power save function to avoid displaying the same image for extended periods of time. An afterimage may appear even after a short time period has elapsed depending on the displayed image. To remove such a phenomenon, change the image or keep the power turned off for several hours.
- If the monitor displays continuously over a long period of time, smudges or burn-in may appear. To maximize the life of the monitor, we recommend the monitor be turned off periodically.
- The LCD panel is manufactured using high-precision technology. Although, missing pixels or lit pixels may appear on the LCD panel, this is not a malfunction. Percentage of effective dots: 99.9994 % or higher.
- The backlight of the LCD panel has a fixed lifetime. Depending on the usage pattern, such as usage for long continuous periods, the lifespan of the backlight may run out sooner, requiring replacement. When the screen becomes dark or begins to flicker, please contact your local EIZO representative.
- Do not scratch or press on the LCD panel with any sharp objects, at this may result in damage to the LCD panel. Do not attempt to brush with tissues as this may scratch the panel.
- (Cautions for the Use of the Touch Panel)
During touch operation
Be careful of the following points. Otherwise, damage may occur to the monitor.
 - Do not strongly press, scratch, or poke the touch panel.
 - Do not touch the touch panel with hard objects such as ballpoint pens or metals.

About the Installation

- If you place this product on a lacquer-coated desk, the color may adhere to the bottom of the stand due to the composition of the rubber. Check the desk surface before use.
- Dew condensation may form on the surface or interior of this product when it is brought into a cold room, when the temperature suddenly rises, or when it is moved from a cold room to a warm room. In that case, do not turn the product on. Instead wait until the dew condensation disappears, otherwise it may cause some damage to the product.

Cleaning

- Periodic cleaning is recommended to keep the product looking new and to prolong its operation lifetime.
- Stains on the product can be removed by moistening part of a soft cloth with water or by using our ScreenCleaner and gently wiping.

Attention
<ul style="list-style-type: none">• Do not let liquids come into direct contact with the product. If it does, wipe it off immediately.• Do not allow liquids to get into gaps or inside the product.• When using chemicals for cleaning or disinfection, chemicals such as alcohol and disinfectant may cause gloss variation, tarnishing, and fading of the product, and also quality deterioration of the displayed image. Do not use chemicals on a frequent basis.• Never use a thinner, benzene, wax, or abrasive cleaner as they may damage the product.• For more information on cleaning and disinfection, please refer to our web site. How to check: Access www.eizoglobal.com and type "disinfect" in the site search box to search.

To Use the Monitor Comfortably

- An excessively dark or bright screen may affect your eyes. Adjust the brightness of the monitor according to the environmental conditions.
- Staring at the monitor for a long time tires your eyes. Take a 10-minute rest every hour.
- Look at the screen from a proper distance and from a proper angle.

CONTENTS

PRECAUTIONS	3
Important	3
Location of Caution Statement	3
Symbols on the unit	3
WARNING	4
CAUTION	8
About This Product	10
About the Usage of This Product	10
About the LCD Panel	10
About the Installation	11
Cleaning	11
To Use the Monitor Comfortably	11
1 Introduction	14
1.1 Package Contents	14
1.2 Controls and Functions	15
1.2.1 Front	15
1.2.2 Rear	16
2 Installation / Connection	17
2.1 Connecting Cables	17
2.2 Turning On the Power	18
2.3 Adjusting the Screen Angle	19
2.4 Installing the Touch Panel Driver	19
2.5 Touch Panel Calibration	19
3 Reference	20
3.1 Attaching an Optional Arm	20
3.2 Specifications	22
3.2.1 LCD Panel	22
3.2.2 Touch Panel	22
3.2.3 Video Signals	22
3.2.4 Communication	22
3.2.5 AC Power	23
3.2.6 DC Power	23
3.2.7 Physical Specifications	23
3.2.8 Operating Environmental Requirements	23
3.2.9 Transport / Storage Conditions	23
Appendix	24
Information for Radio Interference	24

For U.S.A., Canada Only	24
LIMITED WARRANTY	25

1 Introduction

Thank you very much for choosing an EIZO color LCD monitor.

1.1 Package Contents

Check that all of the following items are included in the package. If any of these are missing or damaged, contact your dealer or local EIZO representative listed separately.

Note
<ul style="list-style-type: none">• The User's Manual is not included with the product. Please download it from our web site using the steps below.<ol style="list-style-type: none">1. Access www.eizoglobal.com.2. From the menu, select "Support" > "Manuals".3. In the "Enter model name" text box, enter "FDX1004T", and then press the "Search" button.4. Click the icon for the User's Manual.• It is recommended that the box and packing materials be stored so that they can be used to move or transport this product.

- Monitor
- AC adapter
- Analog signal cable (D-Sub - D-Sub): MD-C87 x 1



- HDMI cable (HDMI - HDMI): HH200HS x 1



- USB cable (USB-A - USB-B): MD-C93 x 1



- Setup Manual (this document)
- VESA mounting screws M4x12 x 4 (free mount only)
- Tie band x 1

1.2 Controls and Functions

1.2.1 Front

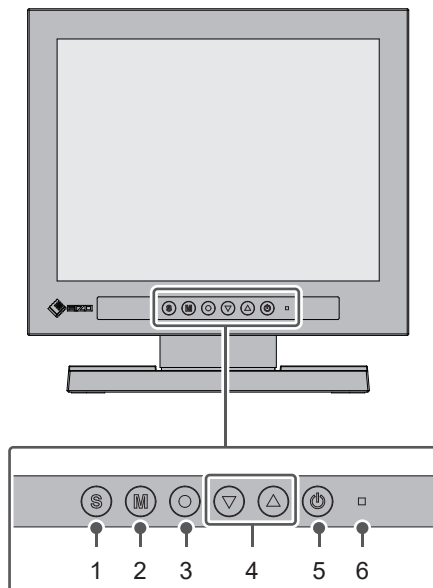

1. S button	Switches the input signals to be displayed.
2. M button	Switches the color mode.
3. O button	Displays the Setting menu, confirms the adjustment items of each menu, and saves adjustment results.
4. V ▲ button	Selects menu items, adjusts/sets functions, and displays the brightness adjustment screen while the Setting menu is displayed.
5. Power button	Turns the power on or off.
6. Power indicator	Indicates the operation status of the monitor. Blue: Screen display Orange: Power saving mode Off: Power off

1.2.2 Rear

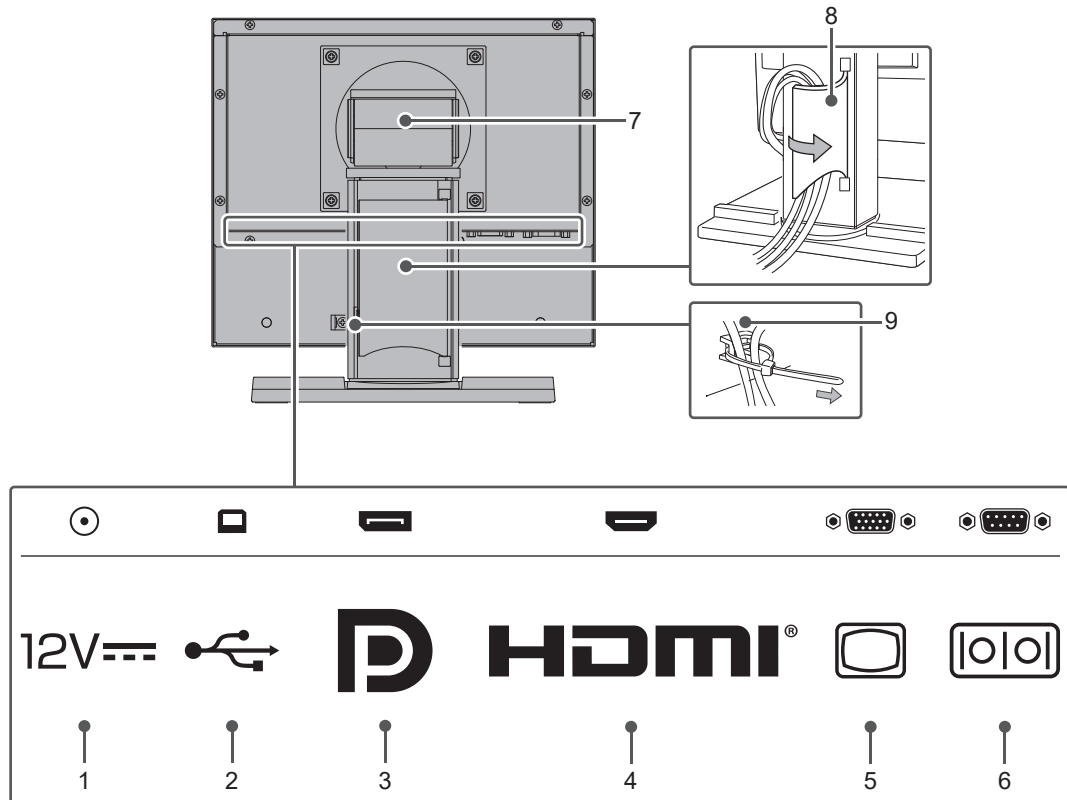

1. Power jack (DC-IN)	Connects the AC adapter.
2. USB-B connector (upstream) ^{*1}	Connect a USB cable to the monitor when you use it as a touch panel monitor.
3. DisplayPort™ connector	Connects to a PC with DisplayPort output.
4. HDMI connector	Connects to a PC with HDMI output. Note • 720p/1080p signals are not supported.
5. D-Sub15 pin (mini) connector	Connects to a PC with D-Sub output.
6. RS-232C port^{*1}	Connect a RS-232C cable to the monitor when you use it as a touch panel monitor.
7. Stand	Allows adjustment of the angle.
8. Cable holder	Holds the monitor cables.
9. Cable tie holder	Attach a cable tie to secure the cable.

^{*1} These cannot be used simultaneously.

2 Installation / Connection

2.1 Connecting Cables

Attention

- Check that the monitor, PC, and peripherals are powered off before connecting.
- When replacing the current monitor with this monitor, refer to "Compatible Resolutions" in the User's Manual to change the PC settings for resolution and vertical scan frequency to those that are available for this monitor, before connecting the PC.

1. Connect signal cables.

Check the shapes of the connectors, and connect the cables. When connecting an HDMI® cable, fasten the cable with the supplied HDMI cable clamp. When connecting a D-Sub mini 15-pin cable, tighten the fasteners down to secure the connector.

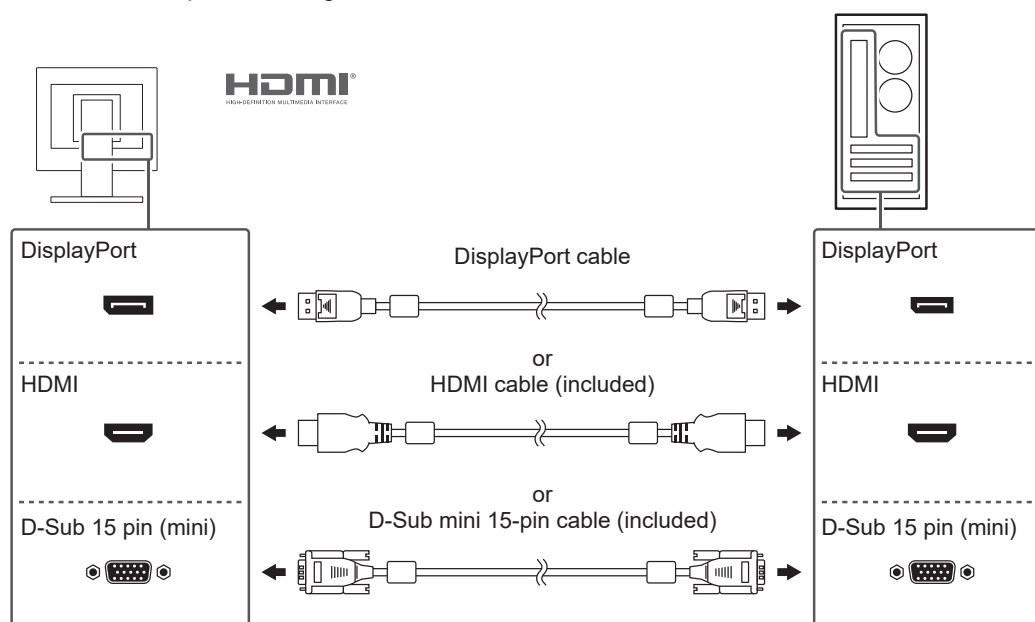

Attention

- When connecting to multiple PCs, switch the input signal. Refer to the User's Manual for details.

Note

- If the cables are difficult to insert, adjust the angle of the screen.

- Use either the USB cable or the RS-232C cable to connect the PC to the monitor.

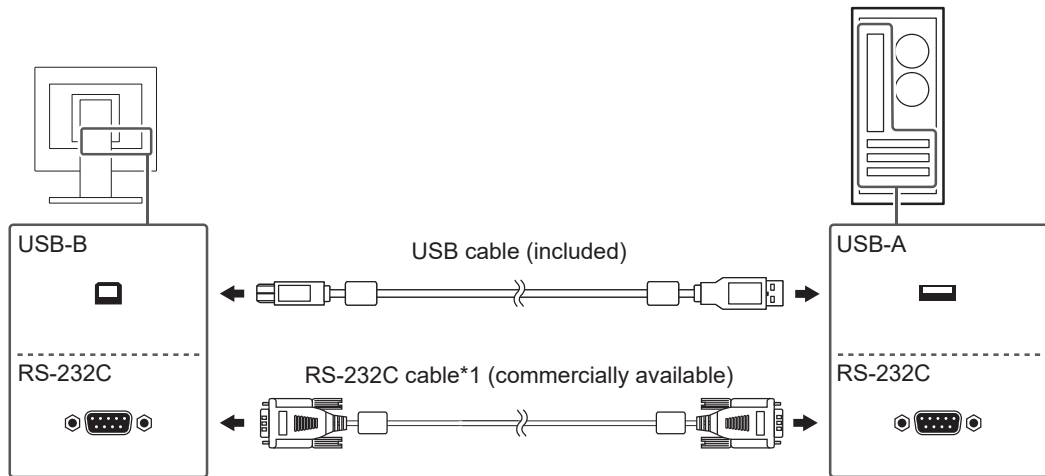

*1 Cross type. The connector type on the monitor is D-Sub 9-pin. In the default settings, RS-232C serial transfer is disabled. For details on how to change the settings, see "Functions of the "Administrator Settings" Menu" in the User's Manual.

- Connect the power cord into the AC adapter.
- Connect the AC adapter to the power jack of the monitor, then connect the power plug to a power outlet.

2.2 Turning On the Power

- Press  to turn on the power.
The power switch indicator of the monitor lights up blue.
If the power indicator does not light up, refer to "No Picture" in the User's Manual.
- Turn on the PC.
The screen image appears.
If the screen image does not appear after turning on the PC, refer to "No Picture" in the User's Manual.

Attention

- For maximum power saving, it is recommended that the Power button be turned off. When not using the monitor, you can disconnect the power plug so that the power is cut completely.

2.3 Adjusting the Screen Angle

Hold the left and right edges of the monitor with both hands, and adjust the angle of the screen to the optimum position for performing tasks.

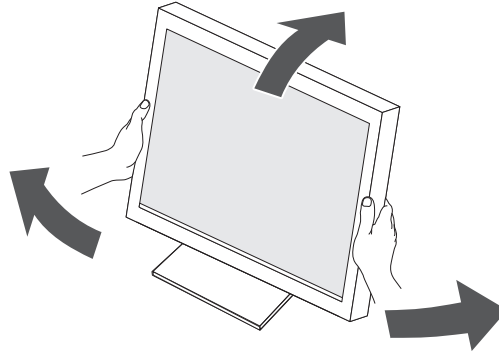

Attention

- After making the adjustment, make sure that the cables are correctly connected.

2.4 Installing the Touch Panel Driver

Attention

- To install the touch panel driver, the user account needs "Administrator" privileges.
- To reinstall the touch panel driver in order to update the driver, uninstall the driver, and then restart the PC before installation.

1. Download the touch panel driver from our web site.

Note

- Use the following procedure to download the touch panel driver from our web site.
 1. Access www.eizoglobal.com.
 2. From the menu, select "Support" > "Software and Drivers".
 3. In the "Enter name of model or software" text box, enter "FDX1004T", and then press the "Search" button.
 4. Click the ZIP icon for the touch panel driver.

2. If another touch panel driver is installed, uninstall it.
3. Install the downloaded touch panel driver.
For information on how to install the touch panel driver, refer to the User's Manual of the touch panel driver.
4. Reboot the PC.

2.5 Touch Panel Calibration

Calibrate the touch panel according to the User's Manual of the touch panel driver.

Note

- If the installation location of the monitor is changed, calibrate the touch panel.

3 Reference

3.1 Attaching an Optional Arm

A monitor arm (or stand) can be attached by removing the stand section.

When attaching a monitor arm or stand, the installable orientations and movement range (tilt angle) are as follows:

- Orientation

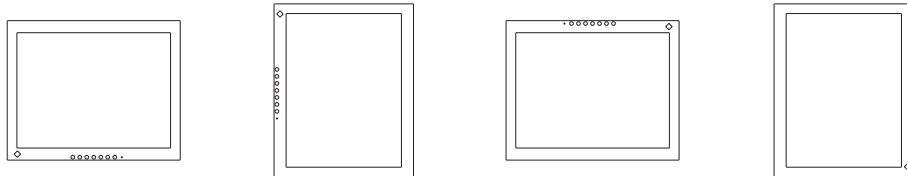

- Movement range (tilt angle)

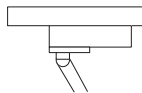

Up: 90°

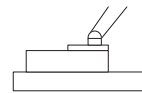

Down: 90°

Attention

- When attaching a monitor arm or stand, follow the instructions of the respective User's Manual.
- When using a monitor arm or stand of another manufacturer, confirm the following in advance and select one conforming to the VESA standard:
 - Clearance between screw holes: 100 mm x 100 mm
 - Plate thickness: 2.6 mm
 - Strong enough to support weight of the monitor unit (excluding the stand) and attachments such as cables
- Connect the cables after attaching an arm or stand.
- The monitor, arm, and stand are heavy. Dropping them may result in injury or equipment damage.
- Check the tightness of the screws periodically. If the screws are not tight enough, the monitor may come unattached. This may be the cause of injury or damage.

1. Lay the LCD monitor on a soft cloth spread over a stable and flat surface with the LCD panel surface facing down.
2. Remove the stand.
Prepare a screwdriver.
Using a screwdriver, remove the screws securing the unit and the stand.
3. Attach the arm or stand to the monitor.
Attach using the VESA mount mounting screws supplied with this product.

When using commercially available screws, use screws that meet the following conditions.

- Nominal diameter: M4
- Length: Between 6.5 mm and 9.5 mm (if using washers, add the washer thickness)

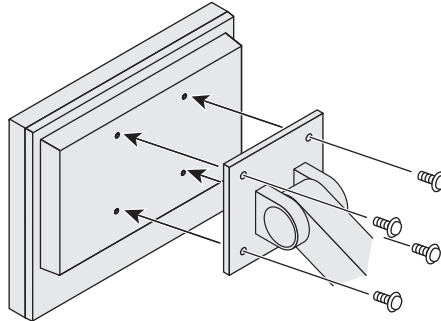

3.2 Specifications

3.2.1 LCD Panel

Type	IPS (Anti-Glare)	
Backlight	LED	
Size	10.4" (26.3 cm)	
Resolution	1024 dots x 768 lines	
Display Size (H x V)	210.4 mm x 157.8 mm	
Pixel Pitch	0.206 mm x 0.206 mm	
Display Colors	8 bit colors: 16.77 million colors	
Viewing Angle (H / V, typical)	176° / 176°	
Contrast Ratio (typical)	1000:1	
Response time (typical)	Black -> White -> Black	25 ms

3.2.2 Touch Panel

Surface coating	Anti-glare	
Surface hardness	2H	
Communication method	USB transfer* ¹ , RS-232C transfer* ¹	
Detection method	Resistive film type	
Supported Operating Systems* ²	Windows 11 Windows 10 (32 bit / 64 bit)	

*¹ These cannot be used simultaneously.

*² EIZO support will end when OS vendor support ends.

3.2.3 Video Signals

Input Terminals		DisplayPort (HDCP 1.3 compatible) x 1, HDMI (HDCP 1.4 compatible)* ¹ x 1, D-Sub 15 pin (mini) x 1
Digital Scanning Frequency (H / V * ²)	DisplayPort, HDMI	31 kHz – 49 kHz / 59 Hz – 61 Hz, 69 Hz – 71 Hz (at 720 x 400)
Analog Scanning Frequency (H / V * ²)	D-Sub	31 kHz to 61 kHz / 55 Hz to 76 Hz
Dot clock (Max.)	DisplayPort, HDMI	65 MHz
	D-Sub	80 MHz
Synchronization Signal		H / V separate, positive / negative

*¹ HDMI CEC (mutual control) is not supported.

*² The vertical scan frequency supported varies according to the resolution. For more information, see "Compatible Resolutions" in the User's Manual.

3.2.4 Communication

USB	Port	USB-B connector (upstream) x 1
	Standard	USB Specification Revision 2.0
RS-232C	Port	D-Sub 9-pin (male) x 1

3.2.5 AC Power

Input	100 – 240 VAC \pm 10 %, Max. 0.3 A (100 VAC), max. 0.2A (240 VAC)	
Maximum Power Consumption	15 W or less	
Power Save Mode	With USB connection	1.5 W or less ^{*1}
	Without USB connection	0.5 W or less ^{*1}
Standby Mode (standard value)	0.3 W	

*1 No external load is connected, default setting

3.2.6 DC Power

Input	DC 12 V \pm 10%, 1.1 A max.	
Maximum Power Consumption	13 W or less	
Power Save Mode	With USB connection	1.5 W or less ^{*1}
	Without USB connection	0.5 W or less ^{*1}
Standby Mode (standard value)	0.3 W	

*1 No external load is connected, default setting

3.2.7 Physical Specifications

Dimensions (W x H x D)	252.0 mm x 254.0 mm x 175.0 mm (Tilt: 0°)	
Dimensions (W x H x D) (Without Stand)	252.0 mm x 216.0 mm x 44.4 mm	
Net Weight	Approx. 3.5 kg	
Net Weight (Without Stand)	Approx. 1.9 kg	
Tilt	- 30° above, 0° below	

3.2.8 Operating Environmental Requirements

Temperature	Monitor	0 °C – 50 °C
	AC adapter	0 °C – 40 °C
Humidity	Monitor	20 % – 90 % R.H. (no dew condensation)
	AC adapter	20 % – 80 % R.H. (no dew condensation)
Air Pressure	540 hPa – 1060 hPa	

3.2.9 Transport / Storage Conditions

Temperature	-20 °C – 60 °C
Humidity	10 % – 90 % R.H. (no dew condensation)
Air Pressure	200 hPa – 1060 hPa

Appendix

Information for Radio Interference

For U.S.A., Canada Only

FCC Supplier's Declaration of Conformity

We, the Responsible Party

Company: EIZO Inc.

Address: 5710 Warland Drive, Cypress, CA 90630

Phone: (562) 431-5011

declare that the product

Trade name: EIZO

Model: DuraVision FDX1004T

is in conformity with Part 15 of the FCC Rules. Operation of this product is subject to the following two conditions: (1) this device may not cause harmful interference, and (2) this device must accept any interference received, including interference that may cause undesired operation.

This equipment has been tested and found to comply with the limits for a Class B digital device, pursuant to Part 15 of the FCC Rules. These limits are designed to provide reasonable protection against harmful interference in a residential installation. This equipment generates, uses, and can radiate radio frequency energy and, if not installed and used in accordance with the instructions, may cause harmful interference to radio communications. However, there is no guarantee that interference will not occur in a particular installation. If this equipment does cause harmful interference to radio or television reception, which can be determined by turning the equipment off and on, the user is encouraged to try to correct the interference by one or more of the following measures.

- Reorient or relocate the receiving antenna.
- Increase the separation between the equipment and receiver.
- Connect the equipment into an outlet on a circuit different from that to which the receiver is connected.
- Consult the dealer or an experienced radio/TV technician for help.

Changes or modifications not expressly approved by the party responsible for compliance could void the user's authority to operate the equipment.

Note

Use the attached specified cable below or EIZO signal cable with this monitor so as to keep interference within the limits of a Class B digital device.

- AC Cord
- Shielded Signal Cable (enclosed)

Canadian Notice

This Class B information technology equipment complies with Canadian ICES-003.
Cet équipement informatique de classe B est conforme à la norme NMB-003 du Canada.

LIMITED WARRANTY

EIZO Corporation (hereinafter referred to as “EIZO”) and distributors authorized by EIZO (hereinafter referred to as the “Distributors”) warrant, subject to and in accordance with the terms of this limited warranty (hereinafter referred to as the “Warranty”), to the original purchaser (hereinafter referred to as the “Original Purchaser”) who purchased the product specified in this document (hereinafter referred to as the “Product”) from EIZO or Distributors, that EIZO and Distributors shall, at their sole discretion, either repair or replace the Product at no charge if the Original Purchaser becomes aware within the Warranty Period (defined below) that the Product malfunctions or is damaged in the course of normal use of the Product in accordance with the description in the instruction manual of the Product (hereinafter referred to as the “User’s Manual”).

The period of this Warranty is two (2) years from the date of purchase of the Product (hereinafter referred to as the “Warranty Period”).

EIZO and Distributors shall bear no liability or obligation with regard to the Product in relation to the Original Purchaser or any third parties other than as provided under this Warranty.

EIZO and Distributors will cease to hold or store any parts (excluding design parts) of the Product upon expiration of seven (7) years after the production of the Product is discontinued.

In repairing the Product, EIZO and Distributors will use renewal parts which comply with our QC standards. If the unit cannot be repaired due to its condition or the stockout of a relevant part, EIZO and Distributors may offer the replacement by a product with equivalent performance instead of repairing it.

The Warranty is valid only in the countries or territories where the Distributors are located. The Warranty does not restrict any legal rights of the Original Purchaser.

Notwithstanding any other provision of this Warranty, EIZO and Distributors shall have no obligation under this Warranty whatsoever in any of the cases as set forth below:

1. Any defect of the Product caused by freight damage, modification, alteration, abuse, misuse, accident, incorrect installation, disaster, adherent dust, faulty maintenance and/or improper repair by third party other than EIZO and Distributors;
2. Any incompatibility of the Product due to possible technical innovations and/or regulations;
3. Any deterioration of the sensor, including measurement value of the sensor;
4. Any defect of the Product caused by external equipments;
5. Any defect of the Product caused by the use under environmental conditions not anticipated by EIZO;
6. Any deterioration of the attachments of the Product (e.g. cables, User’s Manual, CD-ROM, etc.);
7. Any deterioration of the consumables, and/or accessories of the Product (e.g. batteries, remote controller, touch pen, etc.);
8. Any exterior deterioration or discoloration of the Product, including that of the surface of the LCD panel, the touch panel and the protect panel;
9. Any defect of the Product caused by placement in a location where it may be affected by strong vibrations or shocks;
10. Any defect of the Product caused by leaking battery liquid;

11. Any deterioration of display performance caused by the deterioration of expendable parts such as the LCD panel and/or backlight, etc. (e.g. changes in brightness, changes in brightness uniformity, changes in color, changes in color uniformity, defects in pixels including burnt pixels, etc.);
12. Any deterioration or malfunction of the cooling fan caused by adherent dust.

To obtain service under the Warranty, the Original Purchaser must deliver the Product, freight prepaid, in its original package or other adequate package affording an equal degree of protection, assuming the risk of damage and/or loss in transit, to the local Distributor. The Original Purchaser must present proof of purchase of the Product and the date of such purchase when requesting services under the Warranty.

The Warranty Period for any replaced and/or repaired product under this Warranty shall expire at the end of the original Warranty Period.

EIZO OR DISTRIBUTORS ARE NOT RESPONSIBLE FOR ANY DAMAGE TO, OR LOSS OF, DATA OR OTHER INFORMATION STORED IN ANY MEDIA OR ANY PART OF ANY PRODUCT RETURNED TO EIZO OR DISTRIBUTORS FOR REPAIR.

EIZO AND DISTRIBUTORS MAKE NO FURTHER WARRANTIES, EXPRESSED OR IMPLIED, WITH RESPECT TO, INCLUDING, WITHOUT LIMITATION, THE PRODUCT AND ITS QUALITY, PERFORMANCE, MERCHANTABILITY OR FITNESS FOR ANY PARTICULAR USE.

IN NO EVENT SHALL EIZO OR DISTRIBUTORS BE LIABLE FOR ANY INCIDENTAL, INDIRECT, SPECIAL, CONSEQUENTIAL OR OTHER DAMAGE WHATSOEVER (INCLUDING, WITHOUT LIMITATION, DAMAGES FOR LOSS OF PROFIT, BUSINESS INTERRUPTION, LOSS OF BUSINESS INFORMATION, OR ANY OTHER PECUNIARY LOSS) ARISING OUT OF THE USE OR INABILITY TO USE THE PRODUCT OR IN ANY CONNECTION WITH THE PRODUCT, WHETHER BASED ON CONTRACT, TORT, NEGLIGENCE, STRICT LIABILITY OR OTHERWISE, EVEN IF EIZO OR DISTRIBUTORS HAVE BEEN ADVISED OF THE POSSIBILITY OF SUCH DAMAGES.

THIS EXCLUSION ALSO INCLUDES ANY LIABILITY WHICH MAY ARISE OUT OF THIRD PARTY CLAIMS AGAINST THE ORIGINAL PURCHASER. THE ESSENCE OF THIS PROVISION IS TO LIMIT THE POTENTIAL LIABILITY OF EIZO AND DISTRIBUTORS ARISING OUT OF THIS LIMITED WARRANTY AND/OR SALES.



EIZO Corporation

153 Shimokashiwano, Hakusan, Ishikawa 924-8566 Japan

EIZO Europe GmbH

Belgrader Straße 2, 41069 Mönchengladbach, Germany

艺卓显像技术(苏州)有限公司

中国苏州市苏州工业园区展业路8号中新科技工业坊5B

www.eizoglobal.com

Copyright © 2024 EIZO Corporation. All rights reserved.

00N0N459A1
SUM-FDX1004_T

1st Edition – February, 2024