



# Setup Manual

## DuraVision® MDU5501WT

Touch Panel Color LCD Monitor

### Important





Please read this “Setup Manual”, and “User’s Manual” (separate volume) carefully to familiarize yourself with safe and effective usage.

Please retain this manual for future reference.







- 
- For monitor adjustment and settings, refer to the “User’s Manual”.
  - For the latest product information including the “Setup Manual”, refer to our web site :  
[www.eizoglobal.com](http://www.eizoglobal.com)
-

## SAFETY SYMBOLS

This manual and this product use the safety symbols below. They denote critical information. Please read them carefully.

	Failure to abide by the information in a WARNING may result in serious injury and can be life threatening.
	Failure to abide by the information in a CAUTION may result in moderate injury and/or property or product damage.
	Indicates an attention to be required.
	Indicates a prohibited action.

## Symbols on the unit

Symbol	This symbol indicates
	Main Power Switch: Press to turn the monitor's main power off.
	Main Power Switch: Press to turn the monitor's main power on.
	Power button: Press to turn the monitor's power on or off.
	Direct current
	Alternating current
	Alerting electrical hazard
	CAUTION: Refer to "SAFETY SYMBOLS" (page 2).

---

No part of this manual may be reproduced, stored in a retrieval system, or transmitted, in any form or by any means, electronic, mechanical, or otherwise, without the prior written permission of EIZO Corporation. EIZO Corporation is under no obligation to hold any submitted material or information confidential unless prior arrangements are made pursuant to EIZO Corporation's receipt of said information. Although every effort has been made to ensure that this manual provides up-to-date information, please note that EIZO monitor specifications are subject to change without notice.

---

# PRECAUTIONS

## IMPORTANT

- This product is intended for applications such as nautical chart display systems, ship radar displays, and ship engine monitoring.

This product is not developed for applications which would require higher reliability, and safety such as those listed below.

- Safety devices (Disaster prevention system, security control system, etc.)
- Equipment with direct effect on human life (Life support systems, Medical equipment or devices used in the operating room, etc.)
- Nuclear energy control devices (Nuclear energy control systems, security control systems of nuclear facilities, etc.)

- To ensure personal safety and proper maintenance, please read carefully this section and the caution statements on the monitor.

### Location of the Caution Statements

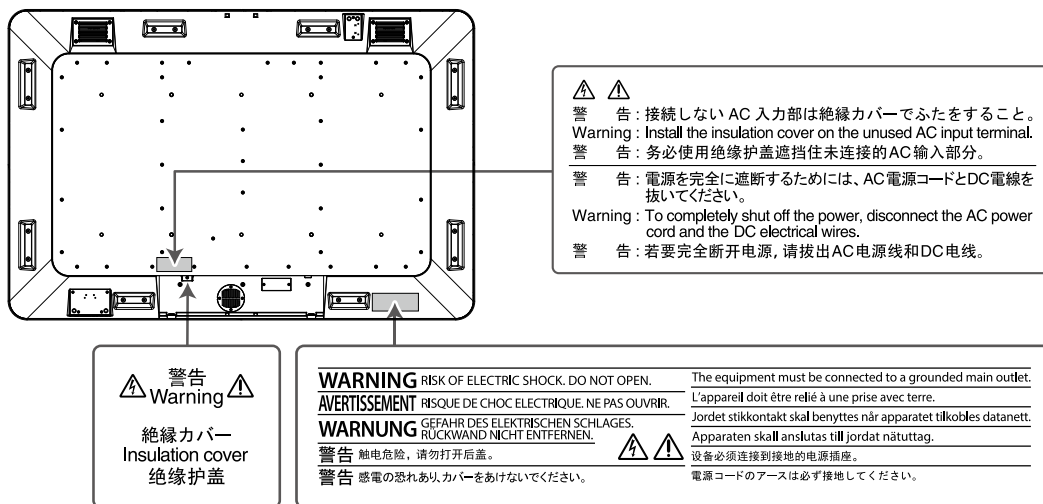

## WARNING

If the unit begins to emit smoke, smells like something is burning, or makes strange noises, disconnect all power connections immediately and contact your local EIZO representative for advice.

Attempting to use a malfunctioning unit may result in fire, electric shock, or equipment damage.

### Do not disassemble or modify the unit.

Opening the cabinet or modifying the unit may result in fire, electric shock, or burn.

The attached stylus includes a battery. When disposing of the stylus, do not disassemble it except for when removing the battery.



### Refer all servicing to qualified service personnel.

Do not attempt to service this product yourself as opening or removing covers may result in fire, electric shock, or equipment damage.

## **WARNING**

---

### **Keep small objects or liquids away from the unit.**

Small objects accidentally falling through the ventilation slots into the cabinet or spillage into the cabinet may result in fire, electric shock, or equipment damage. If an object or liquid falls/spills into the cabinet, block the power supply immediately. Have the unit checked by a qualified service engineer before using it again.



---

### **Use the unit in an appropriate location.**

Not doing so may result in fire, electric shock, or equipment damage.

- Do not place outdoors.
- Do not place in a location where it may be affected by strong vibration or shocks.
- Do not place in a dusty or humid environment.
- Do not place in a location where water is splashed on the screen (bathroom, kitchen, etc.).
- Do not place in a location where the steam comes directly on the screen.
- Do not place near heat generating devices or a humidifier
- Do not place in a location where the product is subject to direct sunlight.
- Do not place in an inflammable gas environment.
- Do not place in environments with corrosive gases (such as sulfur dioxide, hydrogen sulfide, nitrogen dioxide, chlorine, ammonia, and ozone).
- Do not place in environments with dust, components that accelerate corrosion in the atmosphere (such as sodium chloride and sulfur), conductive metals, and so on.



---

### **Install the monitor so that users are unable to touch the power input terminal on the rear of the monitor.**

Touching the power input terminal may result in electric shock.

Apply insulation protection to the power input terminal according to the applicable standards for finished products after enclosure installation.

---

### **Use the unit within the rated voltage range.**

Not doing so may result in fire, electric shock, or equipment damage. Check that the voltage on the monitor input terminal is as follows:

Power supply: AC AC100-240 V, 50 / 60 Hz  
DC DC+24 V

---

### **If using the AC power connector, make sure the power cord meets the following requirements.**

This product does not include a power cord. Please prepare separately a power cord which meets the requirements.

\* The power cord must be compliance with the mandatory standards of the country and region in which this product is to be used.

- For Europe: The power cord set has rated value of at least AC250 V~ 10 A and has cord type H05VV-F, GTCE-3, 0.75 mm<sup>2</sup>.
- For USA: The power cord set has rated value of at least AC125 V~ 10 A and has cord type SVT, 3/18AWG (0.75 mm<sup>2</sup>).
- For Japan: The power cord set has rated value of at least AC125 V~ 7 A and has cord type VCTF, 0.75 mm<sup>2</sup>.
- For China: The power cord set has rated value of at least AC250 V~ 10 A and has cord type “配 60227 IEC53 3×1 平方毫米”

---

### **The equipment must be connected to a grounded main outlet.**

Failure to do so may result in fire or electric shock.



---

### **If using the DC power terminal block, connect it securely.**

Accidental disconnection of the terminal may result in fire, electric shock, or equipment damage.

---

 **WARNING****Use the correct voltage.**

- The unit is designed for use with a specific voltage only. Connection to polarities and voltages other than those specified on the monitor or in this User's Manual may cause fire, electric shock, or equipment damage.
- Do not overload your power circuit, as this may result in fire or electric shock.

**Only supply power after setting up all power connections.**

Connecting the product to a power source with power being supplied may cause electric shock.

**If using the DC power terminal block, do not touch the terminal block while it is electrified.**

Touching the terminal block in this state may result in electric shock.

**To disconnect the power cord, grasp the plug firmly and pull.**

Tugging on the cord may damage and result in fire or electric shock.

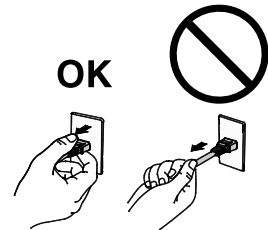
**To remove the DC power terminal block, grasp the terminal block firmly and pull.**

Tugging on the wiring may damage it and may result in fire or electric shock.

**Handle the power cord with care.**

- Do not place the cord underneath the unit or other heavy objects.
- Do not pull on or tie the cord.

If the power cord becomes damaged, stop using it. Use of a damaged cord may result in fire or electric shock.

**Be careful when handling the removed stylus battery.**

- Do not disassemble, heat, wet, or short circuit the battery.
- Follow regional laws and regulations when disposing of the battery.
- See the User's Manual for how to remove the battery.

**Do not touch a damaged LCD panel directly with bare hands.**

The liquid crystal that may leak from the panel is poisonous if it enters the eyes or mouth. If any part of the skin or body comes in direct contact with the panel, please wash thoroughly. If some physical symptoms result, please consult your doctor.

**Periodically check the tightening of screws.**

If screws are loose, the monitor may detach and cause injury or equipment damage.

 **CAUTION**

---

**Handle with care when carrying the unit.**

Disconnect the power cord and cables when moving the unit. Moving the unit with the cord attached is dangerous. It may result in injury.

---

**Unpacking and transporting of this product should be carried out by four or more people.**

As this product is heavy, always ensure that it is unpacked and carried by four or more people. Dropping the unit may result in injury or equipment damage.

---

**Do not get on the monitor, or place any heavy objects on it.**

Doing so may cause a person to fall or the glass to be damaged, resulting in personal injury. In addition, the product may also malfunction.



**Do not block the ventilation slots on the cabinet.**

- Do not place any objects on the ventilation slots.
- Do not install the unit in a closed space.
- Do not use the unit upside down.

Blocking the ventilation slots prevents proper airflow and may result in fire, electric shock, or equipment damage.

---



**Do not touch the plug with wet hands.**

Doing so may result in electrical shock.



**Keep the following items away from the stylus holder.**

- Magnetic recording media such as magnetic cards, prepaid cards and tickets
- Electronic and communication devices such as speakers, CD/DVD players and cell phones

This stylus uses magnets. The magnetic forces may damage their data or hamper the normal operation of such devices.

---



**Periodically clean the area around the plug.**

Dust, water, or oil on the plug may result in fire.

---

**Block the power supply to the unit before cleaning it.**

Cleaning the unit while the power is being supplied may result in electric shock.

---

# CONTENTS

<b>PRECAUTIONS .....</b>	<b>3</b>
<b>CONTENTS .....</b>	<b>7</b>
<b>Chapter 1 Introduction.....</b>	<b>8</b>
<b>1-1. Package Contents.....</b>	<b>8</b>
<b>1-2. EIZO LCD Utility Disk.....</b>	<b>8</b>
● Disk contents.....	8
<b>1-3. Controls and Functions .....</b>	<b>9</b>
● Front / Back .....	9
● Side face .....	10
<b>Chapter 2 Installation / Connection.....</b>	<b>12</b>
<b>2-1. Installation .....</b>	<b>12</b>
● Installation example .....	12
● Installation requirements.....	13
● Checking the strength of the installation location.....	15
● Checking the installation environment .....	15
● Installing a fitting on the monitor main unit ....	15
● Outline Dimensions .....	16
<b>2-2. Connection .....</b>	<b>17</b>
<b>2-3. Displaying the Screen .....</b>	<b>20</b>
<b>2-4. ECDIS setup.....</b>	<b>22</b>
<b>2-5. Turning Power Off .....</b>	<b>22</b>
<b>Chapter 3 Touch Panel Settings .....</b>	<b>23</b>
<b>3-1. Types of Touch Panel Drivers.....</b>	<b>23</b>
<b>3-2. Using Windows Standard Driver.....</b>	<b>23</b>
<b>3-3. Using DMT-DD .....</b>	<b>26</b>
<b>3-4. Enabling or Disabling Touch Panel         Operation .....</b>	<b>26</b>
<b>3-5. How to Use the Stylus (Touch Pen) .....</b>	<b>27</b>
● Turning the power on .....	27
● Charging.....	28
● Checking the stylus.....	28
● Replacing the tip .....	29
● About the stylus holder .....	29
<b>Chapter 4 Troubleshooting.....</b>	<b>31</b>
<b>4-1. No Picture .....</b>	<b>31</b>
<b>4-2. Touch Panel Problems .....</b>	<b>32</b>
<b>Appendix .....</b>	<b>35</b>
<b>Supported Resolutions .....</b>	<b>35</b>
<b>Pin configuration of connectors .....</b>	<b>36</b>
● DC power connector .....	36
● RS232C port (D-Sub 9-pin (female)) .....	36
● RS485 port.....	37
<b>How to replace the cooling fan.....</b>	<b>38</b>
<b>Periodic check of buzzer alarm.....</b>	<b>40</b>

# Chapter 1 Introduction

## 1-1. Package Contents

Check that all the following items are included in the packaging box. If any items are missing, contact your local EIZO representative.

- The monitor
- EIZO LCD Utility Disk (CD-ROM)
- Setup Manual (this manual)
- Stylus (touch pen)
- Tip for stylus (x 2)
- Stylus holder
- Cleaning cloth

## 1-2. EIZO LCD Utility Disk

An "EIZO LCD Utility Disk" (CD-ROM) is provided with this product. The following table shows the disk contents:

### ● Disk contents

The disk includes a touch panel software and user manuals. Refer to the Readme file on the disk for file access procedures.

Contents	
Touch panel software	DMT-DD, Touch Panel Driver (Windows 11 / Windows 10)
	DMT-DD, Touch Panel Driver (Windows 8.1)
	TPOffset*1
User's Manual	Monitor*2
	DMT-DD, Touch Panel Driver
	TPOffset
	Readme

\*1 Software used to adjust the sensitivity of the touch panel. Use this software when touch operations are not registered or if they are only registered after pressing down hard. When installing the monitor for the first time or changing the installation environment, make sure to execute the sensitivity adjustment software "TPOffset".

\*2 Includes outline dimensions.



## 1-3. Controls and Functions



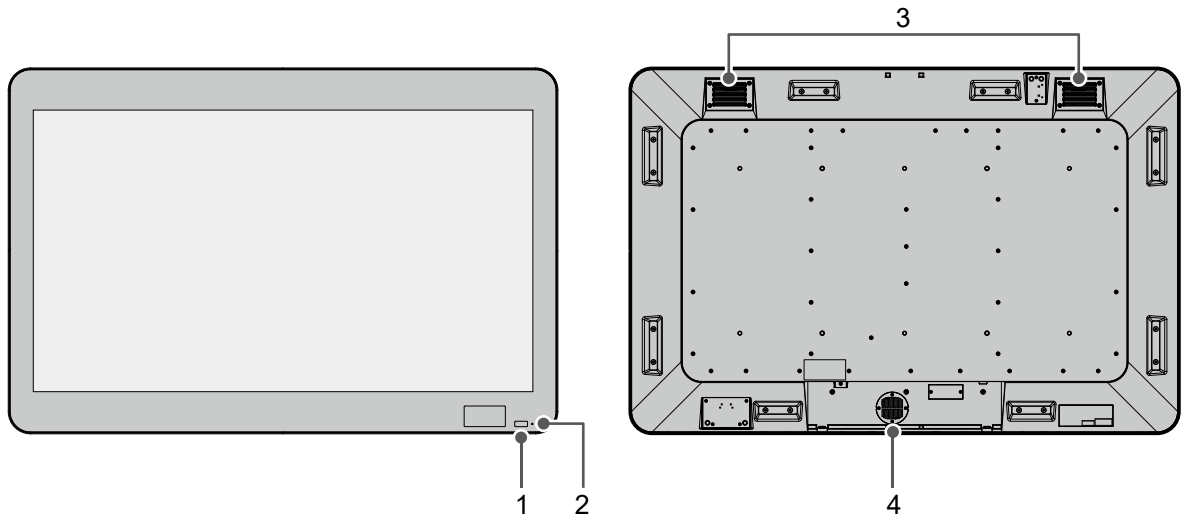



### ● Front / Back

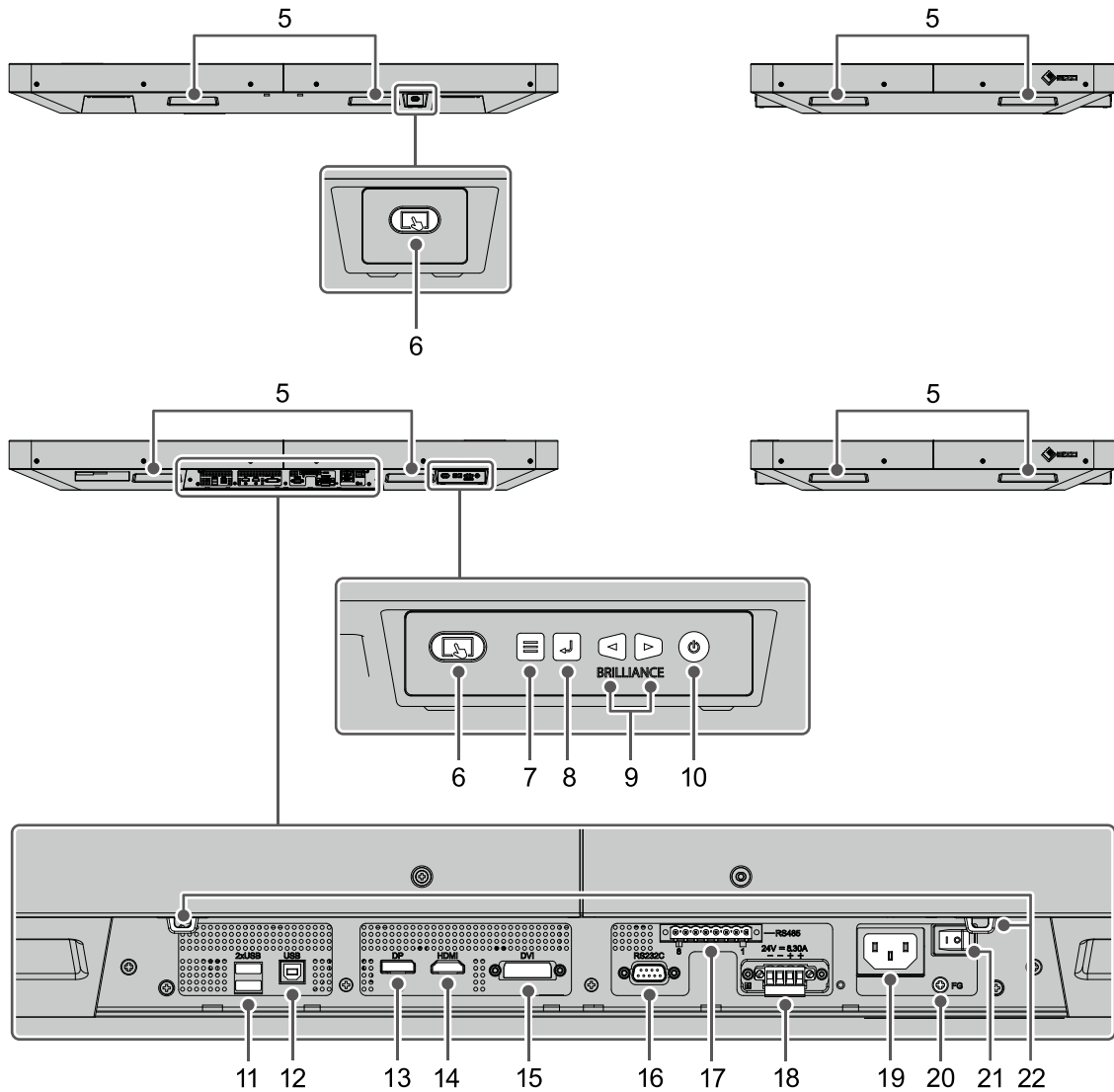

<p><b>1. ECDIS Indicator</b></p>	<p>When the monitor brilliance is set to the ECDIS adjustment value, the letters "ECDIS" light up green.</p> <p><b>Note</b></p> <ul style="list-style-type: none"> <li>• The ECDIS Indicator will not light up in the following situations: <ul style="list-style-type: none"> <li>- When the ECDIS Indicator is set to "Off"</li> <li>- When Color Mode is set to "Custom"</li> <li>- When the monitor brilliance differs from the ECDIS adjustment value.</li> <li>- When the wrong signal is inputted</li> </ul> </li> <li>• While the product can be installed in the range of 0° to 90°, the ECDIS factory shipping adjustment is performed with the monitor in a vertical position.</li> </ul>
<p><b>2. Power lamp</b></p>	<p>Indicates the operation status of the monitor.</p> <p>When green: Normal operation mode  When flickering green: Power saving mode  When turned off: Power off</p>
<p><b>3. Cooling fan</b></p>	<p>Fans to cool the monitor. Operates when the product interior reaches a high temperature.</p>
<p><b>4. Buzzer</b></p>	<p>Can be activated to emit warning beeps by system-side control.</p> <p><b>Note</b></p> <ul style="list-style-type: none"> <li>• For details on system-side control, contact your local EIZO representative.</li> </ul>

## ● Side face



<b>5. Handle</b>	Handles for transportation
<b>6.  button</b>	Enables or disables touch panel operation. The button lights up blue when touch panel operation is enabled.  <b>Note</b> <ul style="list-style-type: none"> <li>• There are two buttons. You can use either one of them according to the installation position of the monitor.</li> <li>• Touch panel calibration (sensitivity adjustment) can be carried out by holding down the button for two seconds with touch panel operation enabled.</li> </ul>
<b>7.  button</b>	Displays the Adjustment menu, or cancels adjustments / settings.
<b>8.  button</b>	Displays the signal name that is currently input. Also confirms an item from the Adjustment menu and saves adjusted values.
<b>9.  buttons</b>	Adjusts the brightness. Also selects Adjustment menu items, and adjusts or configures functions.
<b>10.  button</b>	Turns the power on or off. To turn the power off, hold down  for five seconds or more. The power turns off after the remaining time until it turns off has been displayed.
<b>11. USB downstream port</b>	Connects to a peripheral USB 2.0 device.

<b>12. USB upstream port</b>	Connect a USB cable to this port to: <ul style="list-style-type: none"> <li>• Use the touch panel.</li> <li>• Control the monitor via USB.</li> <li>• Use USB hub function.</li> </ul>
<b>13. DisplayPort connector</b>	Inputs DisplayPort signal of a PC.
<b>14. HDMI connector</b>	Inputs HDMI signal of a PC.
<b>15. DVI (DVI-D) connector</b>	Inputs DVI signal of a PC.
<b>16. RS232C port</b>	D-Sub 9-pin (female) connector Use this connector to control the monitor with RS-232C communication.
<b>17. RS485 port</b>	Use this connector to control the monitor with RS-485 communication.
<b>18. DC power connector</b>	Installs the DC power terminal block. A DC power fuse is installed at factory shipment.
<b>19. AC power connector</b>	Connects the power cord. The insulation cover is attached at factory shipment.
<b>20. Functional earth terminal (FG)</b>	A terminal for grounding (functional earth) designed for safe equipment operation. The tapped hole is M4 (4 mm nominal diameter), 6 mm depth.
<b>21. AC main power switch</b>	Turns the AC main power on or off.   : On, ○ : Off
<b>22. Cable tie holder</b>	For attaching cable ties used to hold the cables.

# Chapter 2 Installation / Connection

## 2-1. Installation

This product can be installed horizontally or vertically.  
(Allowable angle: 0° (horizontal) to 90° (vertical))

### ● Installation example

#### Installation example 1: Horizontal

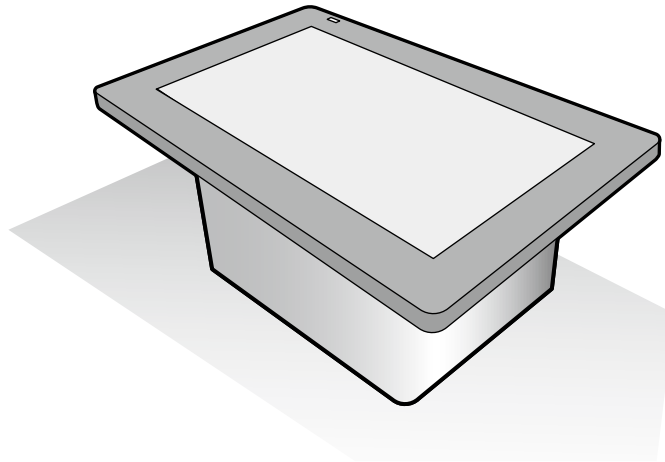

#### Installation example 2: Vertical

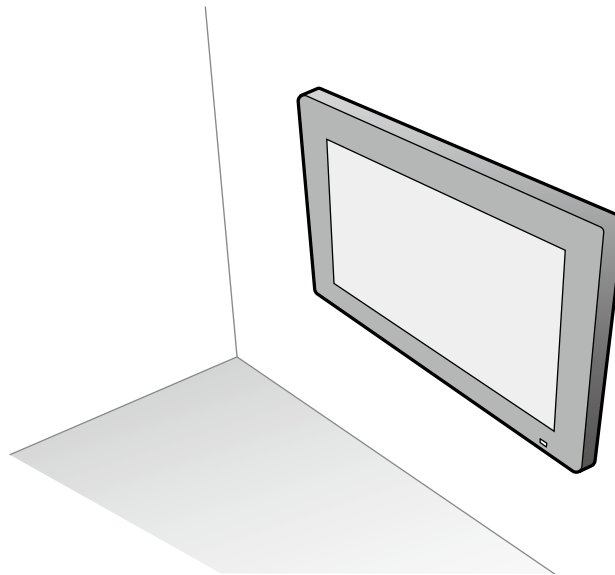

---

#### **Attention**

- When installing the monitor vertically, place it so that the cable connectors are located on the lower side.
- The operation button is located on the side (long side) of the product main unit. Install the product in a place where you can operate the operation button.

---

#### **Note**

- The safety distance between the monitor and compass are as follows.
    - Standard compass: 2.65 m
    - Steering compass: 1.70 m
  - Recommended viewing distance: 1086 mm or more. (\*Based on IEC 62288)
-

## ● Installation requirements

Rear view

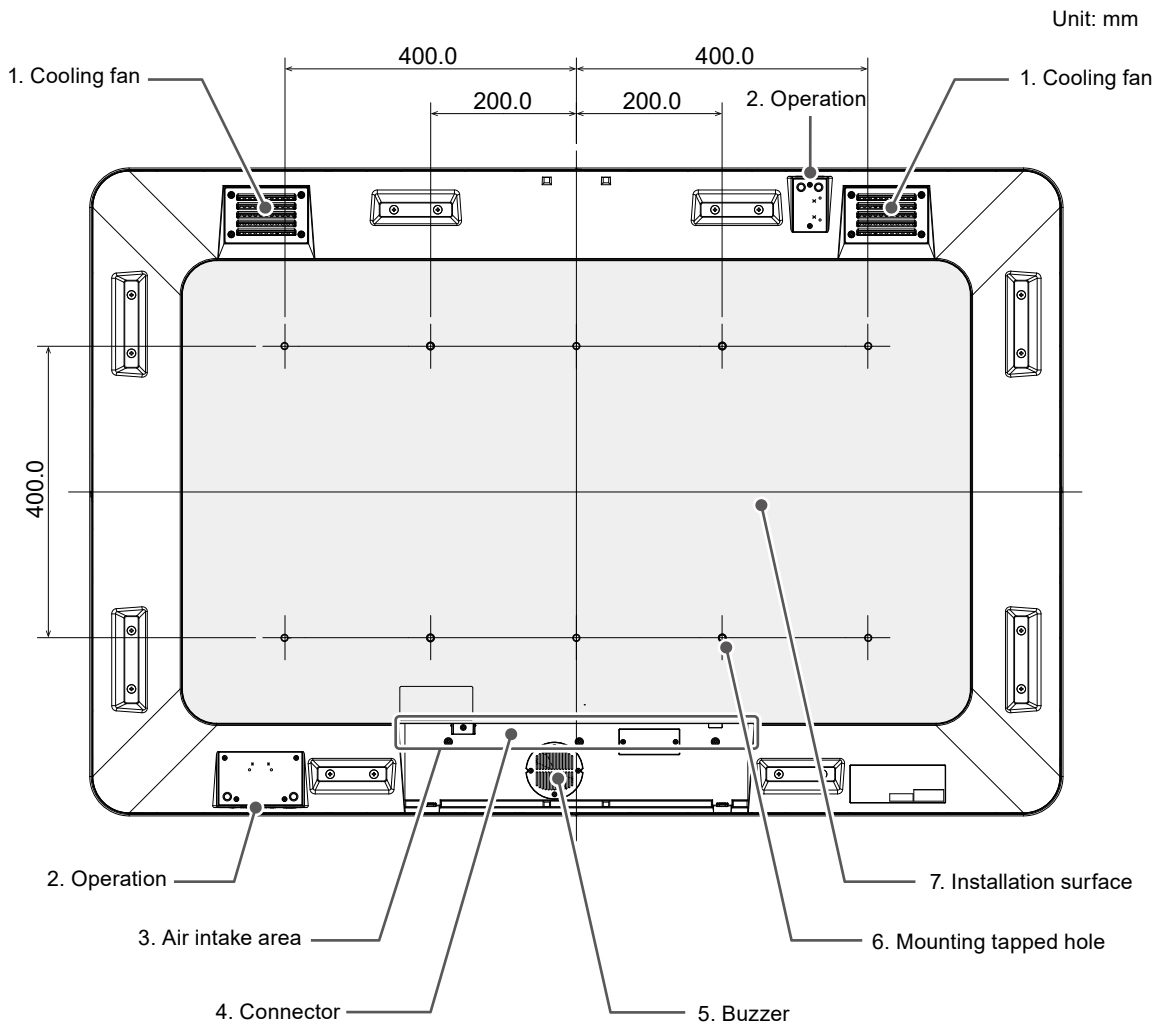

Name	Installation requirements
<b>1. Cooling fan</b>	<ul style="list-style-type: none"> <li>Do not block the area around the cooling fans. Ensure there is sufficient space around the cooling fans so that air can circulate.</li> </ul>
<b>2. Operation</b>	<ul style="list-style-type: none"> <li>Do not block the area around the operation.</li> </ul>
<b>3. Air intake area</b>	<ul style="list-style-type: none"> <li>Do not block the area around the air intake area. Ensure there is sufficient space around the air intake area so that air can circulate.</li> </ul>
<b>4. Connector</b>	<ul style="list-style-type: none"> <li>Do not subject the cable to any excessive load. Note that load on the cable may damage the connector.</li> </ul>
<b>5. Buzzer</b>	<ul style="list-style-type: none"> <li>Do not block the area around the buzzer when using it.</li> </ul>
<b>6. Mounting holes (10 holes)</b>	<ul style="list-style-type: none"> <li>Mounting screws are not provided. Prepare 10 pcs of M8 (8 mm nominal diameter) screws with thread pitch of 1.25 mm, separately.</li> <li>Depth of the tapped hole is 15 mm. Embed the screw 12 mm to 15 mm (inclusive) below the surface.</li> <li>Align the 10 mounting holes in the monitor with those in a table, etc., then secure the monitor using the screws. Be sure to fully tighten the 10 screws (recommended torque: 10 N·m to 12 N·m).</li> </ul>
<b>7. Installation surface</b>	<ul style="list-style-type: none"> <li>The installation surface must have a flatness of within 2 mm.</li> </ul>

## ● Ensuring ventilation

Ensure ventilation by following the explanation of the figures below:

### Air intake area

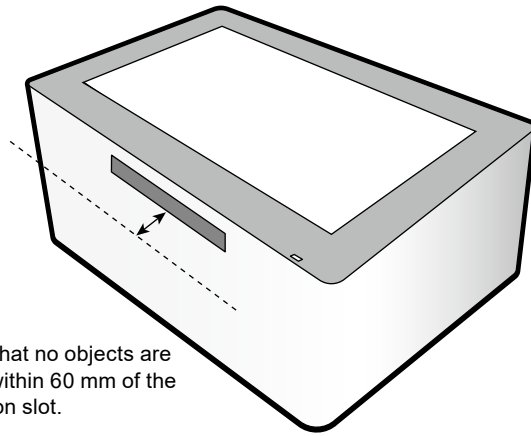

Ensure that no objects are placed within 60 mm of the ventilation slot.

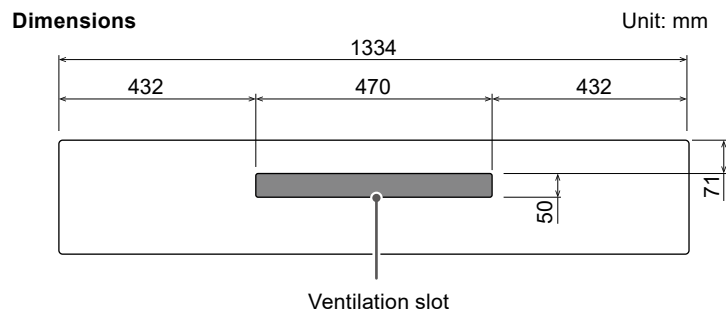

### Air exhaust area (cooling fan)

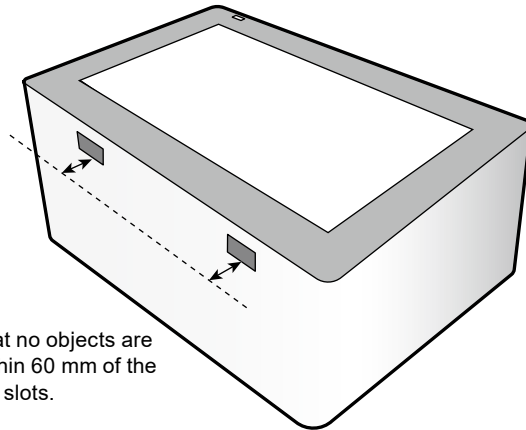

Ensure that no objects are placed within 60 mm of the ventilation slots.

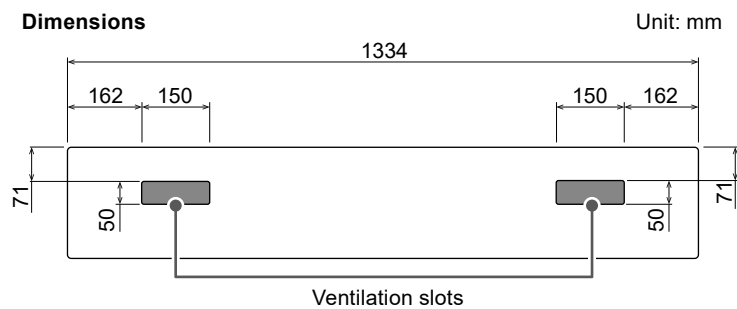

## ● Checking the strength of the installation location

The weight of this product is approximately 71.7 kg. Check the withstand loads of the installation location and fittings used.

## ● Checking the installation environment

- When mounting the monitor on a wall, pay attention to lighting equipment, sprinklers, and sensors on the ceiling.
- To ensure performance and prevent malfunctions of the monitor, do not install it in the following locations:
  - Where the monitor may be subjected to strong vibrations and/or impacts
  - Where dew tends to form as a result of air from an air conditioner or fluctuating temperatures
  - Where water droplets may fall from an air conditioner installed above the monitor
  - Near the source of a magnetic field, heat, steam, or greasy fumes
  - Next to fluorescent lights or devices that produce electrical noise
- The operation button is located on the side of the product main unit. Install the product in a place where you can operate the operation button.

## ● Installing a fitting on the monitor main unit

### Attention

- Mounting fitting is not provided. Please prepare separately.

1. To prevent the surface of the LCD panel from being damaged, lay the monitor with its panel surface facing down on a thick, soft cloth spread on a stable surface.
2. Install the fitting on the monitor.
 

Align the 10 mounting holes in the monitor with those in the fitting, then secure the fitting using the screws (recommended torque: 10 N·m to 12 N·m).

### Installation example

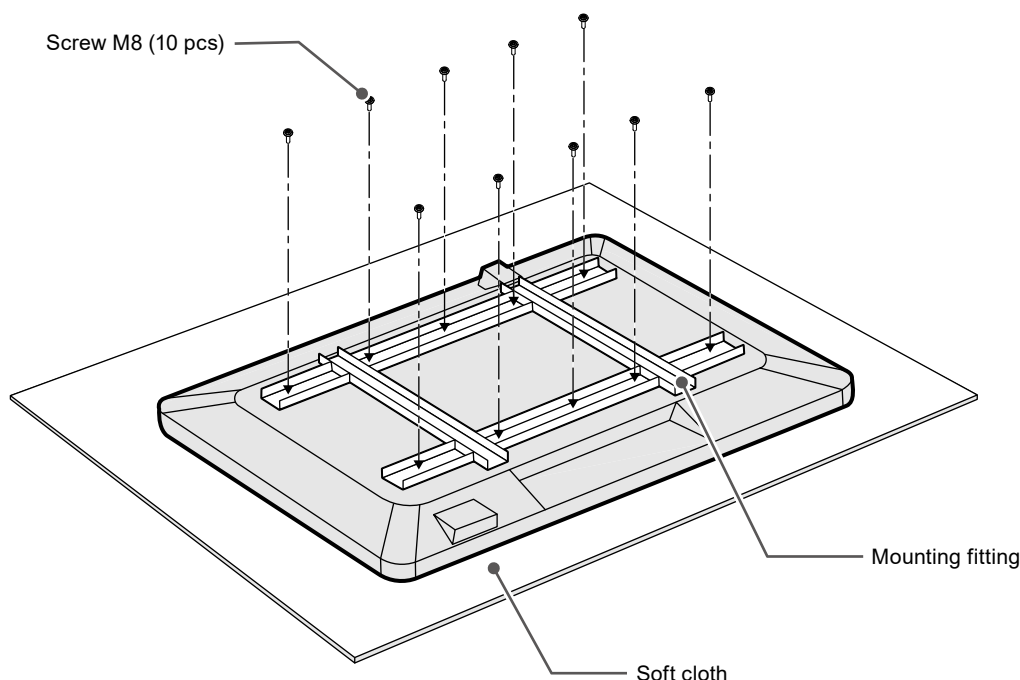

## ● Outline Dimensions

Unit: mm

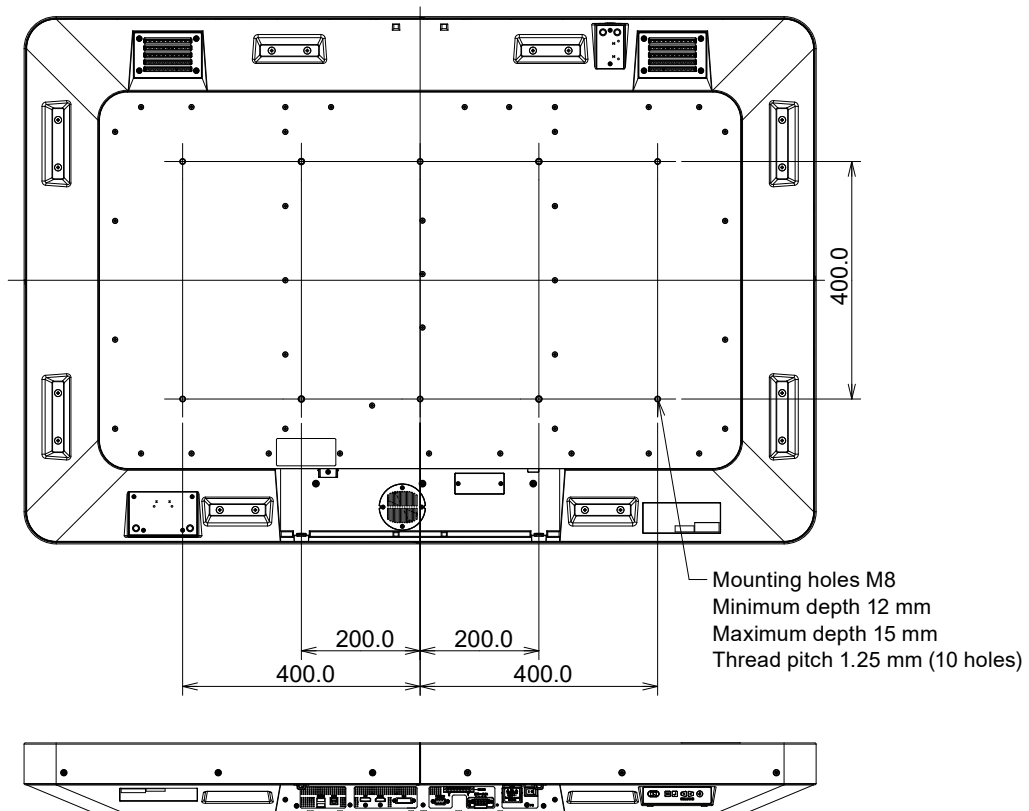
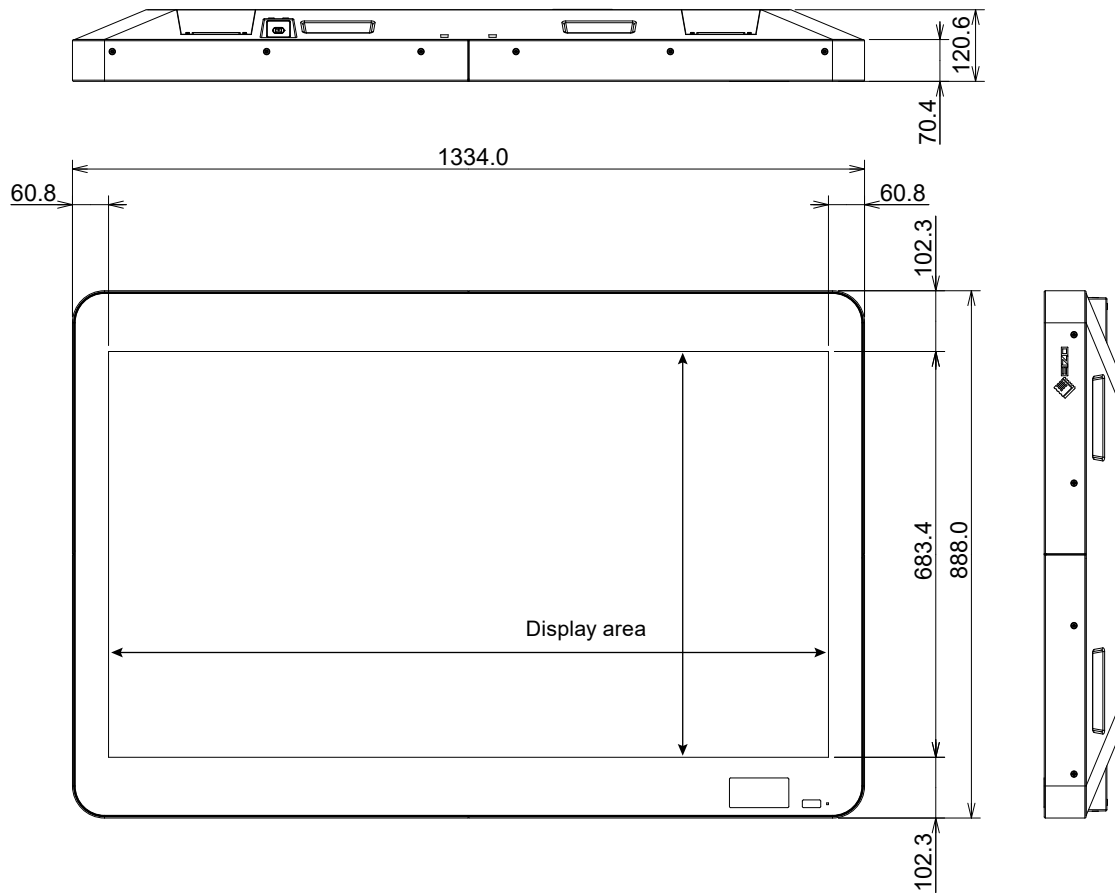



## 2-2. Connection

### Attention

- Confirm the operation and performance of the cables before using them.
- Check the shapes of the connectors, and connect the cables.
- After a connector with a securing screw is plugged in, tighten the screw of the connector to secure the coupling.
- Use signal cables and USB cables shorter than 5 m. The upper cable length limit differs depending on the set resolution and cables used. Select the most appropriate cables according to your usage environment.

### 1. Connect a signal cable.

Prepare and connect a cable appropriate for your computer.

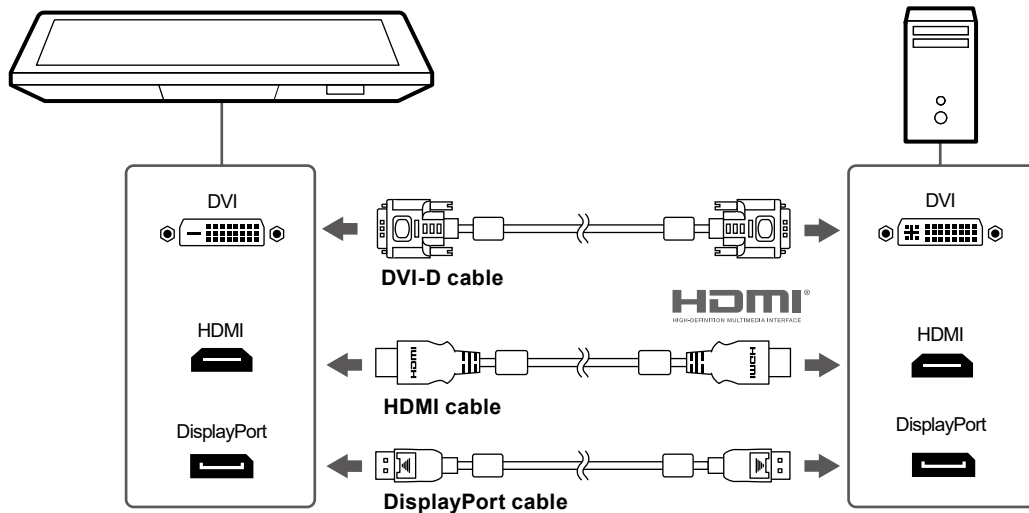

### 2. Connect a USB cable. This is required for controlling the touch panel, or for controlling the monitor from the system.

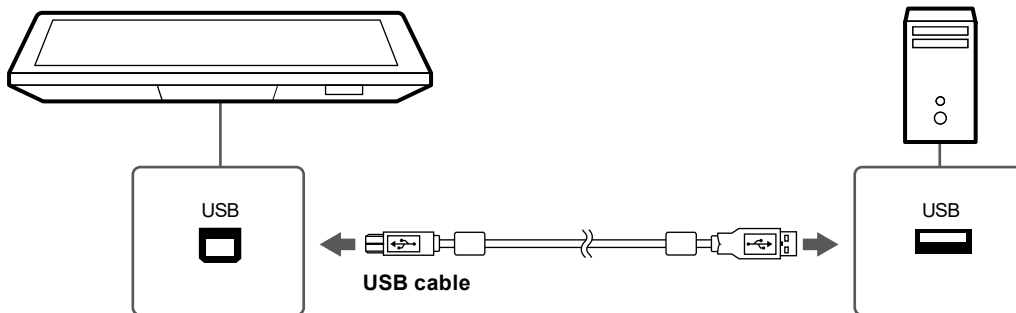

### 3. Connect a communication cable. Prepare and connect a cable required for controlling the monitor.

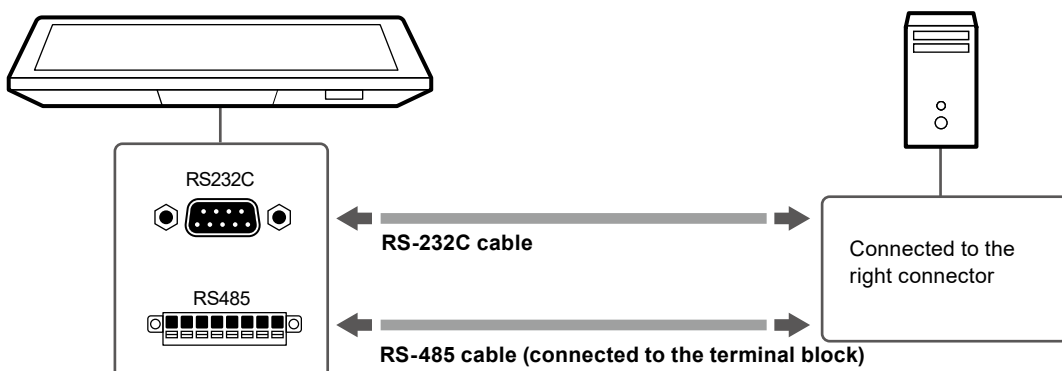

## 4. Connect the monitor to a power supply.

There are two options for connecting the monitor to a power supply. Carry out the connection according to the installation environment and conditions of use.

- Using the DC power terminal block
- Using the AC power connector

### Attention

- Do not supply the monitor with power until it has been properly connected to a power source.

### Note

- When both of the power supplies are connected, AC power is prioritized.

### ● Using the DC power terminal block

#### Attention

- It is strongly recommended to separate the FG and terminal (GND) and connect the FG.

Disconnect the terminal block.

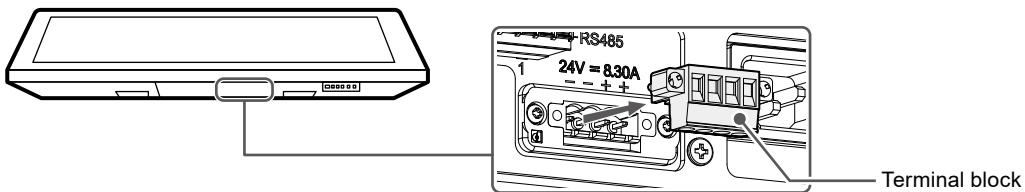

### 3. Connect the electrical wires to the terminal block.

#### Attention

- Use electrical wire of AWG 18 to 12 (0.8 mm<sup>2</sup> to 3 mm<sup>2</sup>).

#### 1. Strip the insulation from the electrical wires (stripping length: 7±0.5 mm).

Add a ferrule to the end of each wire, if required.

Use ferrules manufactured by PHOENIX CONTACT.



#### 2. Insert the electrical wire into the terminal block. Secure it by tightening the clamp screw from the bottom using a flat-head screwdriver with a tip width of 2.5 mm.

The input polarities of the terminal block are shown below.

Pin No.	Input Polarity
1	DC +24 V
2	DC +24 V
3	GND
4	GND

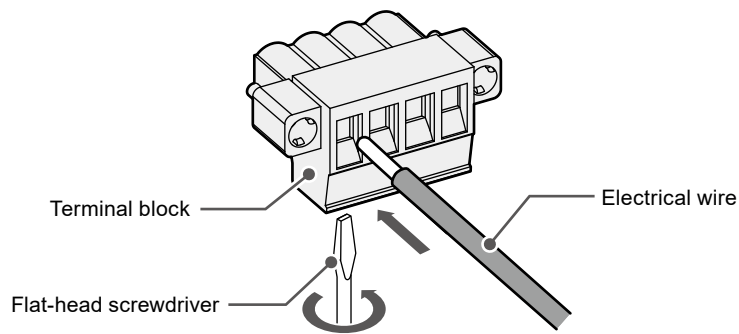

### 3. Install the terminal block.

Install the terminal block to the monitor main unit, and tighten the left and right clamp screws using a flat-head screwdriver with tip width of 2.5 mm (recommended torque: 0.2 N·m to 0.3 N·m).

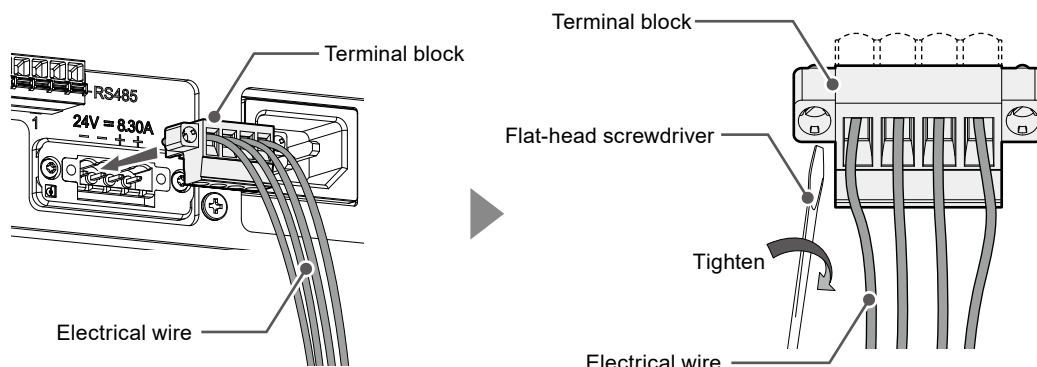

### ● Using the AC power connector

1. Remove the insulation cover from the AC power connector.
2. Connect the power cord to the AC power connector.  
Ensure that the power plug is secured.
3. Connect the power cord to the power outlet.

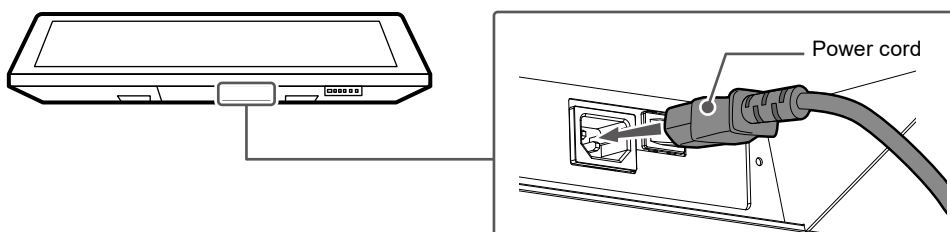

#### Attention

- Do not remove the insulation cover if you do not use the AC power connector.

## 5. Bundle the cables with a cable tie to prevent disconnection.

#### Attention

- Make sure to secure cords and cables (AC power cords, USB cables, HDMI cables) that are not non-slip.
- Cable ties are not provided with this product. Please prepare separately.

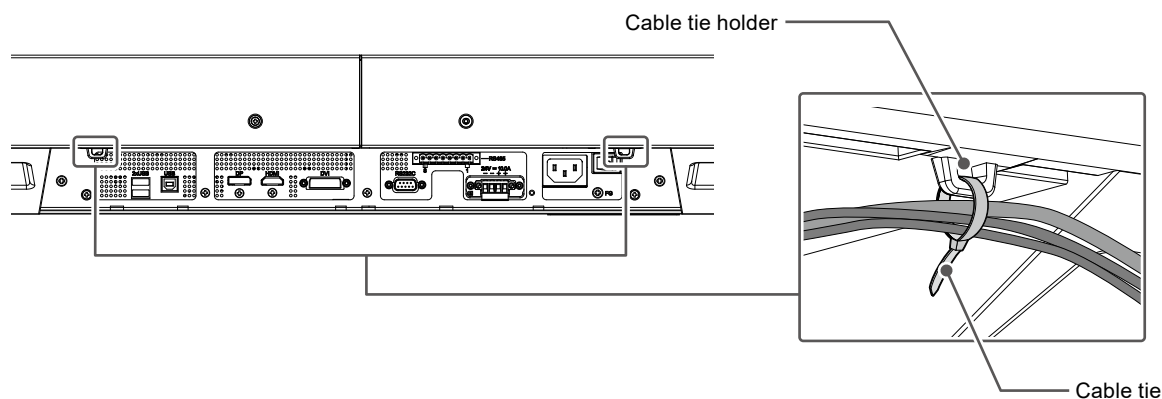

## 2-3. Displaying the Screen

1. When using the AC power supply, make sure the AC main power switch is turned ON. (It is set to ON by factory default.)

 lights up green when the switch is ON.

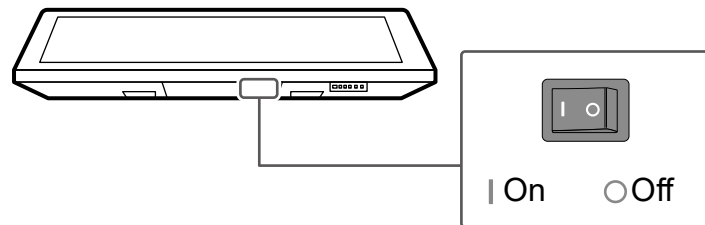

2. Press  to turn on the monitor.

The monitor operation buttons light up green. ( is blue.)

Calibration of the touch panel automatically starts.

Do not touch the touch panel until the message "Don't touch the panel. Calibrating..." disappears from the screen.

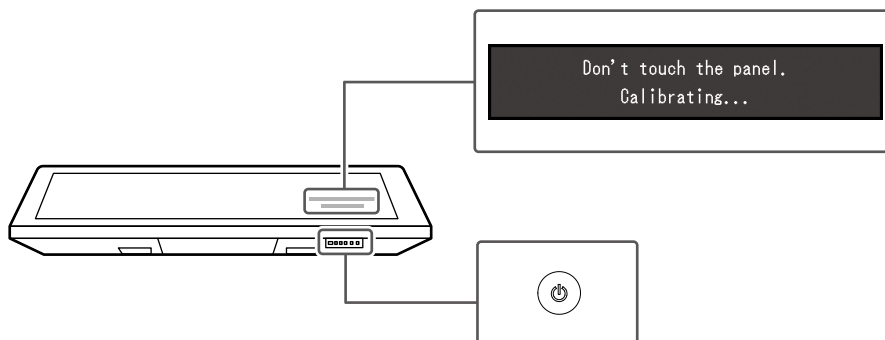

3. Turn on the PC.

The display will turn ON.

## 4. If an image does not appear, switch the input signal.

### Procedure

1. Press .  
The connector name of the currently displayed signal appears at the bottom right of the screen.
2. Press   to switch signals.
3. Press  to apply the change.

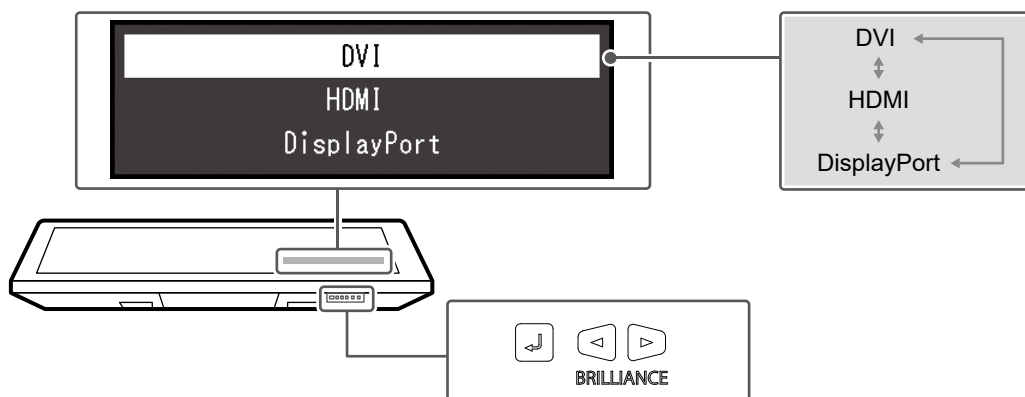

If an image does not appear even after switching input signals, refer to “4-1. No Picture” (page 31).

## 5. Adjust the brightness.

Adjust the brightness of the screen to suit the installation environment and/or personal preference.

### Adjustable Range

0 % to 100 %

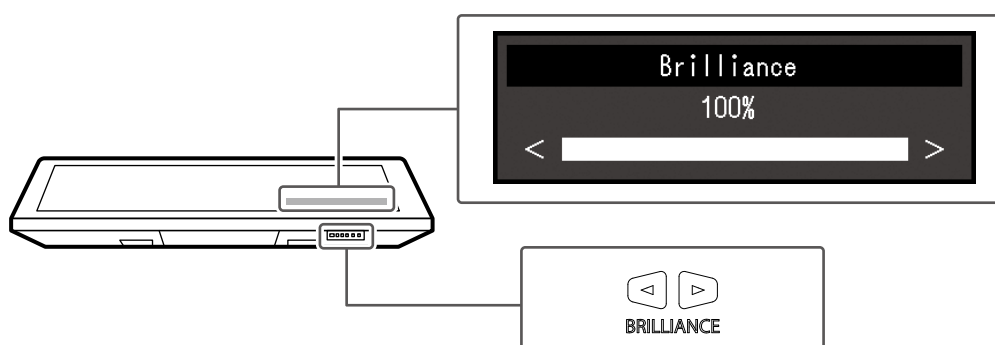

## 2-4. ECDIS setup

---

This monitor can be integrated into ECDIS (Electronic Chart Display and Information System). To integrate, the following information is required:

- ECDIS Color Tables Specifications
- Monitor Control Commands Specifications

For details, contact your local EIZO representative or visit our website ([www.eizoglobal.com](http://www.eizoglobal.com)) to send us an inquiry.

Monitor setting is required to display in compliance with ECDIS standards. For details, refer to the monitor User's Manual (in the CD-ROM).

## 2-5. Turning Power Off

---

### 1. Hold down the button for five seconds or more.

The power turns off after the remaining time until it turns off has been displayed on the screen.

 Control buttons other than go off.

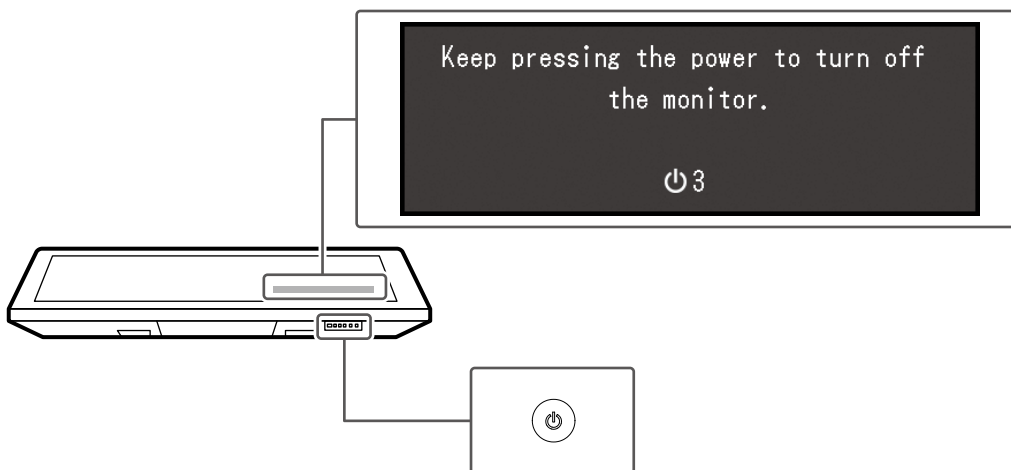

---

#### Attention

- Pull out the AC power cord and DC electrical wire to cut off power completely.
-

# Chapter 3 Touch Panel Settings

## 3-1. Types of Touch Panel Drivers

The following table shows the touch panel drivers that can be used for this monitor. Available functions differ depending on the driver. Use one of the drivers.

√: Supported ×: Not supported

Function	Windows standard driver	Dedicated touch panel driver (DMT-DD) <sup>*1</sup>	
Installing the driver	Not required	Required	
Touch sound output	×	√	
Multiple connections <sup>*2</sup>	√ <sup>*3</sup>	√	
Operation mode	Touch digitizer <sup>*4</sup>	Touch digitizer <sup>*4.5</sup>	Mouse emulation <sup>*5</sup>
Multi-touch operation	√	√	×
PbyP	×	√	√

\*1 Included in the EIZO LCD Utility Disk (CD-ROM)

\*2 √: Can connect two or more monitors to one computer

\*3 Only available in Windows 11 / Windows 10.

\*4 Touch operations may not be recognized on an application designed to use mouse emulation.

\*5 For details on the procedure, refer to the touch panel driver User's Manual (in the CD-ROM).

## 3-2. Using Windows Standard Driver

### Attention

- Installation of DMT-DD is required when using the touch panel with PbyP display. For more information, see "3-3. Using DMT-DD" (page 26).

When using Windows standard driver, set up the driver according to the following procedure. You do not need to install the driver.

### 1. Connecting a USB cable

Make sure the USB cable has been connected between the monitor and PC (see page 17).

### 2. Setting the sensitivity

Execute the application "TPOffset" found in the EIZO LCD Utility Disk (CD-ROM), and adjust the sensitivity of the touch panel. For details, refer to the TPOffset User's Manual (in the CD-ROM).

### Attention

- Do not put your hands or any metal close to the screen because the screen is sensitive to objects of high electrical conductivity.
- When you have changed the installation location and angle of the monitor, be sure to execute "TPOffset".

### 3. Running calibration

---

**Attention**

- If a "User Account Control" dialog box is displayed during operation, proceed according to the displayed instructions.
- 

1. Open the Windows Control Panel.

The method for opening the Control Panel differs depending on the OS.

**Windows 11**

From the Start menu, click "All Apps" - "Windows Tools" - "Control Panel".

**Windows 10**

In the Start Menu, click "Control Panel" under "Windows System".

**Windows 8.1**

1. Click  at the bottom of the "Start" screen.
  2. The "Apps" screen appears.
  3. Click "Control Panel" under "Windows System".
2. Click "Hardware and Sound" - "Tablet PC Settings".

The "Tablet PC Settings" window appears.

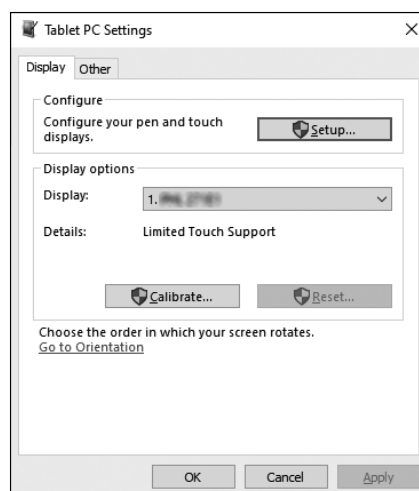

3. Click "Setup" in the "Display" tab.

A touch screen specification screen with a white background is displayed.

---

**Attention**

- If using the monitor in a multiple monitor environment, specify the touch screen according to the message displayed on screen.
- 

4. Touch the screen with your finger.

The touched screen is recognized as a touch screen.

---

**Attention**

- Do not use the stylus (touch pen). The stylus may not be recognized correctly.
- 

5. Press "Enter" on the keyboard.

The "Tablet PC Settings" window reappears.



- Click "Calibrate".

A calibration screen with a white background is displayed.

**Attention**

- If using the monitor in a multiple monitor environment, select the monitor to be used for calibration from the "Display" pulldown menu and then click "Calibrate".

- Touch the calibration target (cross) for a few seconds with your finger and release.

The calibration target appears on the screen 16 times, starting from the top left to top right and then down to the bottom left to bottom right.

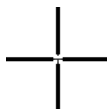

**Note**

- For second or subsequent calibrations, the calibration target appears four times.

- After completing calibration, click "Yes" to save the calibration data.

- Click "OK" to close the window.

## 4. Configuring the operation method

- Open the Windows Control Panel.

The method for opening the Control Panel differs depending on the OS (see page 24).

- Click "Hardware and Sound" - "Pen and Touch".

"Pen and Touch" window appears.

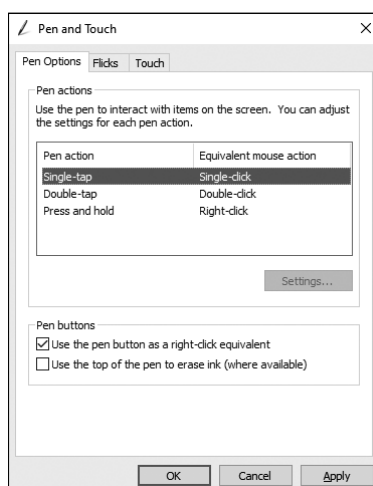

- Configure the touch panel operation settings in the "Pen and Touch" window. For detailed settings, refer to the settings on each tab and Windows Help.

- After completing settings, click "OK" to close the window.

## 3-3. Using DMT-DD

When using the touch panel driver provided by EIZO (DMT-DD), set up the driver according to the following procedure:

### 1. Connecting a USB cable

Make sure the USB cable has been connected between the monitor and PC (see page 17).

### 2. Installing the driver

Install the touch panel driver "DMT-DD" from the EIZO LCD Utility Disk (CD-ROM). Continue the procedure and configure the touch panel settings.

For details, refer to Chapter 1 and 2 of the DMT-DD User's Manual (in the CD-ROM).

### 3. Setting the sensitivity

Execute the application "TPOffset" found in the EIZO LCD Utility Disk (CD-ROM), and adjust the sensitivity of the touch panel. For details, refer to the TPOffset User's Manual (in the CD-ROM).

#### Attention

- When you have changed the installation location and angle of the monitor, be sure to execute "TPOffset".

### 4. Configuring the operation method



Set up the operation method of the touch panel. For details, refer to Chapter 3 and the subsequent chapters of the DMT-DD User's Manual (in the CD-ROM).

## 3-4. Enabling or Disabling Touch Panel Operation

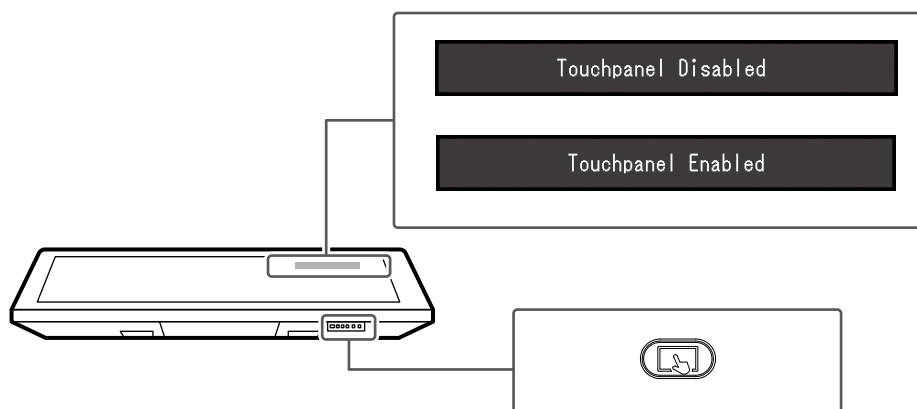
Toggle between enabling and disabling touch panel operation if necessary. (It is enabled by factory default.)



#### Note

- If the touch panel does not respond normally, try performing sensitivity adjustment for the touch panel. Hold down  for two seconds or more to perform sensitivity adjustment. Do not touch the touch panel until the message "Don't touch the panel. Calibrating..." disappears from the screen. For more information, see "4-2. Touch Panel Problems" (page 32).
- When the monitor and computer is not connected with a USB cable,  cannot be used to switch between enable / disable or change sensitivity.

## 3-5. How to Use the Stylus (Touch Pen)

Configure the touch panel settings before using the stylus (see “Chapter 3 Touch Panel Settings” (page 23)).

### ● Turning the power on

1. Press the power button.

The power lamp lights up green once.

To turn the power off, press the power button again. The power lamp lights up red once and the power turns off.

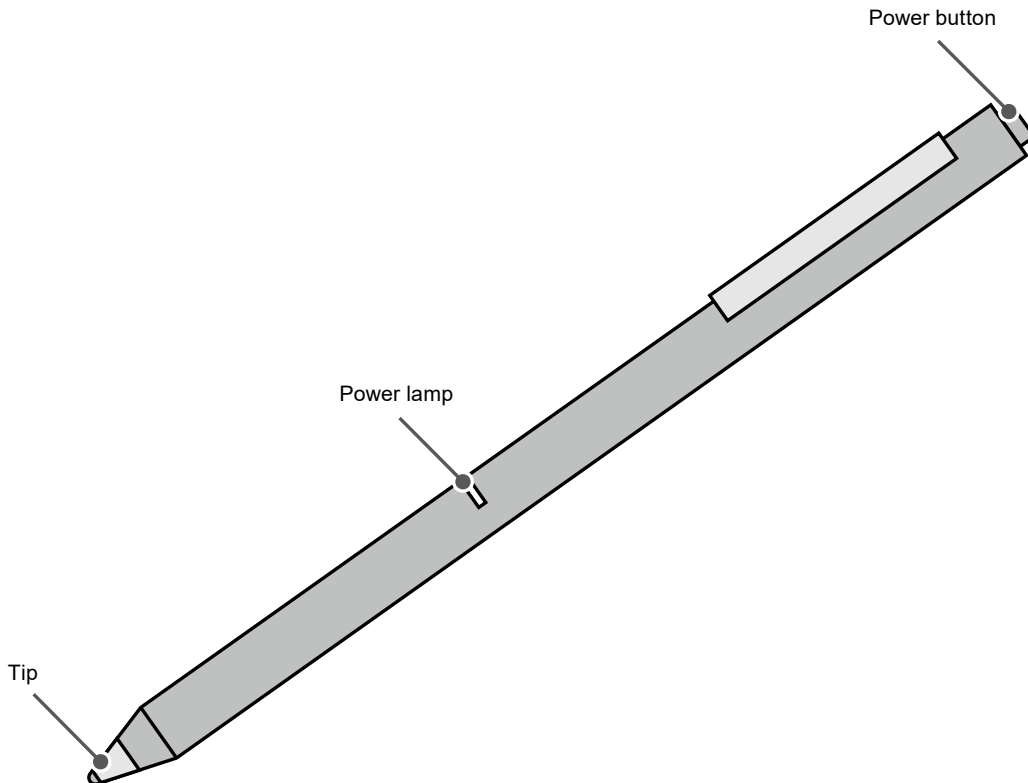

---

**Note**

- To reduce battery consumption, the stylus will automatically turn off 15 minutes after turning on the power. Turn the main power switch on again if you want to continue using the stylus.
-

## ● Charging

The stylus provided with this product is charged via USB. When the battery power is low, the power lamp lights up red when the power is turned on. Recharge using the accompanying USB charger. When charging, the power lamp lights up red. When charging is finished, the light turns to green.

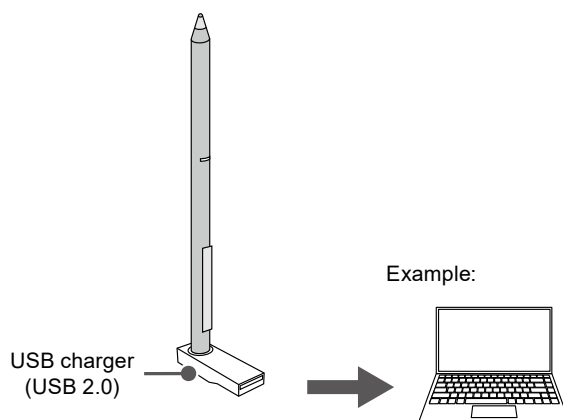

## ● Checking the stylus

1. Launch the Windows Paint application.
2. Hold the stylus vertically against the touch panel, and draw a line from left to right.
3. Make sure the line is visible. If the line is not visible, check whether the power is turned on.

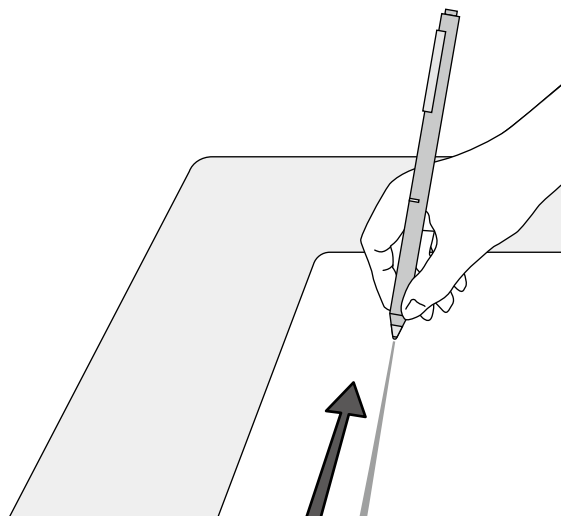

---

### Attention

- Hold the stylus firmly near the pen tip when using it. If you hold the stylus too far from its tip or hold it too lightly, sensitivity may be reduced.
  - The pen tip is fragile. Handle with care. Dropping the stylus may cause damage.
-

## ● Replacing the tip

When the tip is worn away or broken, it must be replaced.

### **Attention**

- Do not use the stylus if the tip is broken or removed. Doing so may damage the monitor surface.

### **Replacement procedure**

1. Turn the tip counter clockwise and remove it.
2. Attach a new tip and turn it clockwise to secure it.

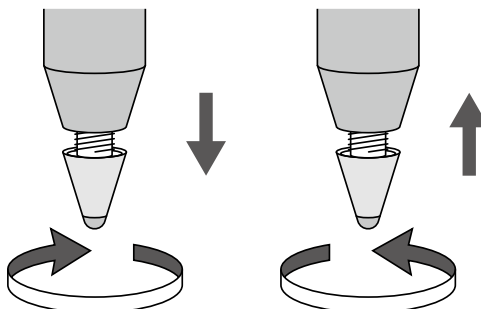

## ● About the stylus holder

You can attach the stylus holder to the monitor. The magnet at the bottom of the holder lets you attach the holder to the positions shown in the figure below.

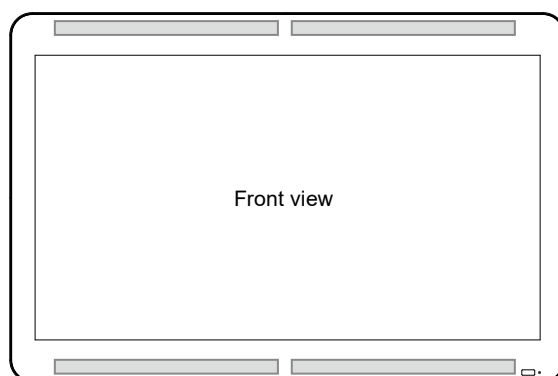
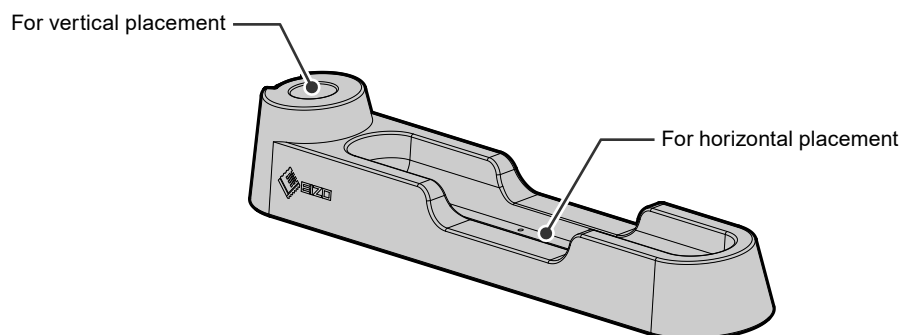

 Positions where the stylus holder can be attached.

---

**Attention**

- When not using the stylus, place it in the stylus holder. If it is placed directly on the touch panel, it will be detected as a foreign object, disabling the touch panel automatically.
- The stylus holder uses a strong magnet. Be careful of the following:
  - Do not bring magnetic storage media and electronic equipment close to the stylus holder. Otherwise, magnetic force may hamper normal operations.
  - Do not drag the stylus holder on the monitor. Doing so may scratch or damage the monitor surface.
  - Do not place the stylus holder on a metallic table or shelf. Doing so may scratch or damage the table or shelf surface.



---

**Note**



- The stylus holder can only be used on a horizontally installed monitor. It cannot be used when the monitor is vertical.
-

# Chapter 4 Troubleshooting



## 4-1. No Picture

Problem	Possible cause and remedy
<p><b>1. No picture</b></p> <ul style="list-style-type: none"> <li>• None of the operation buttons light up.</li> </ul> <hr/> <ul style="list-style-type: none"> <li>• Only the  button lights up green.</li> <li>• All operation buttons light up green or the  button blinks green.</li> </ul>	<ul style="list-style-type: none"> <li>• Check whether the power cord is connected properly.</li> <li>• Turn the main power switch on.</li> <li>• Turn off the main power, and then turn it on again a few minutes later.</li> <li>• If the monitor is used in a low temperature environment, leave the monitor for a while with the power turned on, then turn the power off and on.</li> </ul> <hr/> <ul style="list-style-type: none"> <li>• Press .</li> <li>• Adjust the brightness (brilliance) of the screen.</li> <li>• Move the mouse or press any key on the keyboard.</li> <li>• Check whether the PC is turned on.</li> <li>• Switch the input signal (see “4. If an image does not appear, switch the input signal.” (page 21)).</li> </ul>
<p><b>2. Messages like the ones below appear.</b></p> <ul style="list-style-type: none"> <li>• This message appears when no signal is input. Example:</li> </ul> <div data-bbox="285 1070 657 1207" style="border: 1px solid black; background-color: black; color: white; padding: 10px; text-align: center;"> <p>DVI No Signal</p> </div> <hr/> <ul style="list-style-type: none"> <li>• The message shows that the input signal is out of the frequency specification range. Example:</li> </ul> <div data-bbox="285 1330 657 1467" style="border: 1px solid black; background-color: black; color: white; padding: 10px; text-align: center;"> <p>DVI Signal Error</p> </div>	<p>This message appears when the signal is not input correctly even when the monitor is functioning correctly.</p> <hr/> <ul style="list-style-type: none"> <li>• The message shown left may appear, because some PCs do not output the signal immediately after the power turns on.</li> <li>• Check whether the PC is turned on.</li> <li>• Check whether the signal cable is connected properly.</li> <li>• Switch the input signal (see “4. If an image does not appear, switch the input signal.” (page 21)).</li> </ul> <hr/> <ul style="list-style-type: none"> <li>• Check whether the PC is configured to meet the resolution and vertical scan frequency requirements of the monitor (see “Supported Resolutions” (page 35)).</li> <li>• Reboot the PC.</li> <li>• Select an appropriate display mode using the graphics board’s utility. Refer to the User’s Manual of the graphics board for details.</li> </ul>

## 4-2. Touch Panel Problems

Problem	Possible cause and remedy
<p>1. Touch is not working.</p>	<ul style="list-style-type: none"> <li>• Touch panel operation may be disabled. Press the  button to enable it. The  button lights up blue.</li> <li>• Check that the monitor and PC are connected with a USB cable.</li> <li>• Turn the monitor off and on.</li> <li>• This product automatically disables touch panel operations when moisture or any other objects (including styluses and smartphones) that may cause a malfunction are detected on the touch panel surface. (Water Detection Function) Remove water or objects on the touch panel if the following message is displayed:</li> </ul> <div style="text-align: center; background-color: black; color: white; padding: 5px; margin: 10px 0;"> <p>Water or other substance detected. Touch input not available.</p> </div> <ul style="list-style-type: none"> <li>• Wait a while before resuming operation.</li> <li>• Check that the power cord of the monitor and PC is connected to a grounded main outlet. Failure to ground the equipment may result in a malfunction.</li> <li>• Check that fluorescent lights and other sources of noise are not installed nearby. Malfunction may occur if there are sources of noise installed close by.</li> <li>• Hold down  for two seconds or more to perform touch panel sensitivity adjustment. Do not touch the touch panel until the message "Don't touch the panel. Calibrating..." disappears from the screen.</li> <li>• Perform touch panel sensitivity adjustment using TPOffset.</li> <li>• If two or more PCs are connected to the monitor, only one of them can perform touch operations. Check that the monitor and PC used for touch operations are connected with a USB cable.</li> </ul>



Problem	Possible cause and remedy
<p><b>2. Cursor position is not correct. / Cursor jumps.</b></p>	<ul style="list-style-type: none"> <li>• Connect the monitor to the PC with the cable indicated in the Setup Manual. The touch panel may not work correctly if a conversion adapter is used.</li> <li>• Turn the monitor off and on.</li> <li>• Hold down  for two seconds or more to perform touch panel sensitivity adjustment. Do not touch the touch panel until the message "Don't touch the panel. Calibrating..." disappears from the screen.</li> <li>• Check that the power cord of the monitor and PC is connected to a grounded main outlet. Failure to ground the equipment may result in a malfunction.</li> <li>• Perform touch panel sensitivity adjustment using TPOffset.</li> <li>• Changing the position or angle of the monitor may cause the cursor to jump.</li> <li>• Keep metals away from the touch panel surface as they may lead to incorrect cursor positioning.</li> <li>• If the touch panel is dirty, the touch panel may not operate properly. Clean the touch panel surface. (Refer to the monitor User's Manual in the CD-ROM.)</li> <li>• The spray for preventing static electricity may affect the sensitivity of the touch panel and cursor positioning.</li> <li>• Do not touch the touch panel for five seconds after the PC starts up, after turning on the monitor, or after connecting the cable. Touching the touch panel too soon may cause incorrect cursor positioning or disable touch operations. If this occurs, either refrain from touching the touch panel for approximately two minutes, or turn the monitor off and on again. If the problem persists, calibrate the screen again.</li> <li>• When displaying at a resolution other than the recommended resolution, the touch position and cursor position may shift due to the scaling function of the graphics board. In that case, check the graphics driver settings and change the scaling to the monitor. After changing the settings, perform calibration again.</li> </ul>
<p><b>3. The cursor does not appear at the touched position and instead is displayed at a point-symmetric position with respect to the center of the screen.</b></p>	<ul style="list-style-type: none"> <li>• Calibrate the screen again.</li> </ul>
<p><b>4. Cursor is jittery. / Lines drawn are not straight and smooth.</b></p>	<ul style="list-style-type: none"> <li>• Check that the power cord of the monitor and PC is connected to a grounded main outlet. Failure to ground the equipment may result in a malfunction.</li> <li>• Hold down  for two seconds or more to perform touch panel sensitivity adjustment. Do not touch the touch panel until the message "Don't touch the panel. Calibrating..." disappears from the screen.</li> <li>• Perform touch panel sensitivity adjustment using TPOffset.</li> <li>• Cursor may be jittery under the interference of metal.</li> <li>• Leave space between monitors when multiple monitors are placed close to each other.</li> </ul>

Problem	Possible cause and remedy
<p><b>5. Calibration does not work correctly.</b></p>	<ul style="list-style-type: none"> <li>• Hold down  for two seconds or more to perform touch panel sensitivity adjustment. Do not touch the touch panel until the message "Don't touch the panel. Calibrating..." disappears from the screen.</li> <li>• Perform touch panel sensitivity adjustment using TPOffset.</li> <li>• Readjust the touch panel to the original state (by clicking "Reset" in the "Display" tab of the "Tablet PC Settings" window accessible from the Windows Control Panel) and then calibrate the touch panel again.</li> <li>• When using PbyP display, install DMT-DD and configure necessary settings. For more information, see "3-3. Using DMT-DD" (page 26).</li> </ul>
<p><b>6. No touch sound is heard.</b></p>	<ul style="list-style-type: none"> <li>• If you have set touch sound to be output through the audio output terminal of the PC, connect speakers.</li> <li>• Install DMT-DD and configure necessary settings. For details, refer to the DMT-DD User's Manual (in the CD-ROM).</li> <li>• Touch sound cannot be heard when Windows standard driver is used.</li> </ul>

**Attention**

- For details on TPOffset (software used to adjust the sensitivity of the touch panel), see the TPOffset User's Manual (in the CD-ROM).

# Appendix

## Supported Resolutions

The monitor supports the following resolutions:

√: Supported -: Not supported

Resolution	Vertical scan frequency (Hz)	DisplayPort			HDMI			DVI		
		1 screen	PinP	PbyP	1 screen	PinP	PbyP	1 screen	PinP	PbyP
640 × 480	59.940	√	√	√	√	√	√	√	√	√
640 × 480	60.000	√	√	√	√	√	√	√	√	√
720 × 400	70.087	√	√	√	√	√	√	√	√	√
720 × 480	59.941	√	√	√	√	√	√	√	√	√
720 × 480	59.940	√	√	√	√	√	√	-	-	-
720 × 480	60.000	√	√	√	√	√	√	-	-	-
800 × 600	60.317	√	√	√	√	√	√	√	√	√
1024 × 768	60.004	√	√	√	√	√	√	√	√	√
1280 × 960	60.000	√	√	√	√	√	√	√	√	√
1280 × 1024	60.020	√	√	√	√	√	√	√	√	√
1280 × 720	59.940	√	√	√	√	√	√	√	√	√
1280 × 720	60.000	√	√	√	√	√	√	√	√	√
1600 × 1200	60.000	√	√	√	√	√	√	√	√	√
1680 × 1050	59.883	√	√	√	√	√	√	√	√	√
1680 × 1050	59.954	√	√	√	√	√	√	√	√	√
1920 × 1080	29.970	√	√	√	√	√	√	-	-	-
1920 × 1080	30.000	√	√	√	√	√	√	-	-	-
1920 × 1080	59.940	√	√	√	√	√	√	√	√	√
1920 × 1080	59.963	√	√	√	√	√	√	-	-	-
1920 × 1080	60.000	√	√	√	√	√	√	√	√	√
1920 × 2160	59.988	-	-	√	-	-	√	-	-	-
2560 × 1440	59.951	√	-	-	-	-	-	-	-	-
3840 × 2160 <sup>*1</sup>	29.970	√	-	-	√	-	-	-	-	-
3840 × 2160 <sup>*1</sup>	29.981	√	-	-	-	-	-	-	-	-
3840 × 2160 <sup>*1</sup>	30.000	√	-	-	√	-	-	-	-	-
3840 × 2160 <sup>*1</sup>	59.940	√	-	-	√	-	-	-	-	-
3840 × 2160 <sup>*1</sup>	59.997	√	-	-	-	-	-	-	-	-
3840 × 2160 <sup>*1</sup>	60.000	√	-	-	√	-	-	-	-	-

\*1 Recommended resolution

### Note

- Only supports progressive scan method.

# Pin configuration of connectors

## ● DC power connector

Connector

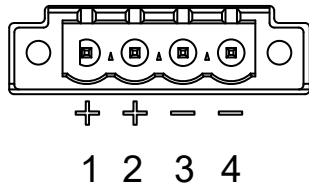

Manufacturer	Monitor Connector Model	Terminal Block Model
PHOENIX CONTACT	IC 2.5/4-STGF-5.08	MSTB 2.5/4-STF-5.08

Pin configuration

Pin No.	Signal
1	DC +24 V
2	DC +24 V
3	GND
4	GND

## ● RS232C port (D-Sub 9-pin (female))

Connector

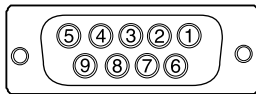

Pin configuration

Pin No.	Signal	Pin No.	Signal
1	DCD <sup>*1</sup>	6	DSR <sup>*1</sup>
2	TXD	7	RTS <sup>*2</sup>
3	RXD	8	CTS <sup>*2</sup>
4	DTR <sup>*1</sup>	9	RI <sup>*1</sup>
5	GND		

\*1 NC

\*2 Connected

## ● RS485 port

Connector

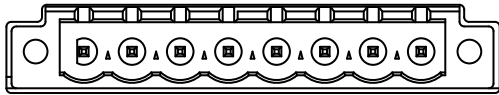

1 2 3 4 5 6 7 8

Manufacturer	Monitor Connector Model	Terminal Block Model
PHOENIX CONTACT	MSTB 2.5/8-GF-5.08	FKCN 2.5/8-STF-5.08

Pin configuration

Pin No.	Signal	Pin No.	Signal
1	TX_485_P	5	RX_485_P
2	TX_485_N	6	RX_485_N
3	TX_COM	7	RX_COM
4	TX_SHIELD	8	RX_SHIELD

# How to replace the cooling fan

## Attention

- Be sure to follow the procedure when replacing the fan. Note that EIZO Corporation assumes no responsibility for any damage caused due to incorrect handling of this product.

## Note

- Please contact your local EIZO representative for replacement parts.

## 1. Disconnect the AC power cord and DC power terminal block.

## 2. Remove the fan cover and fan holder.

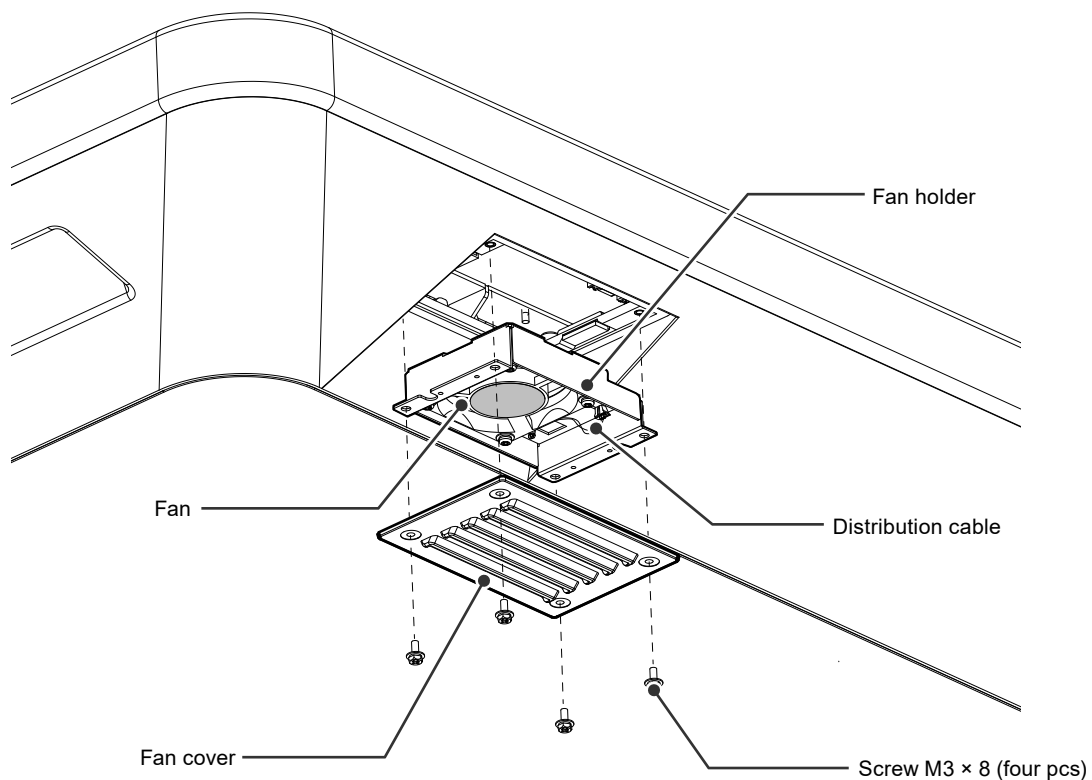

1. Remove the screws (four pcs) that secure the cover.  
Use a box-end wrench with 3 mm nominal diameter (with offset) to remove the screws.
2. Remove the cover.
3. Disconnect the distribution cable connected to the monitor.
4. Remove the holder.  
The holder is temporarily attached to the monitor using a face fastener.

## Attention

- Hold the connector when removing the distribution cable. Pulling on the distribution cable may damage the connector.

### 3. Remove the fan from the fan holder.

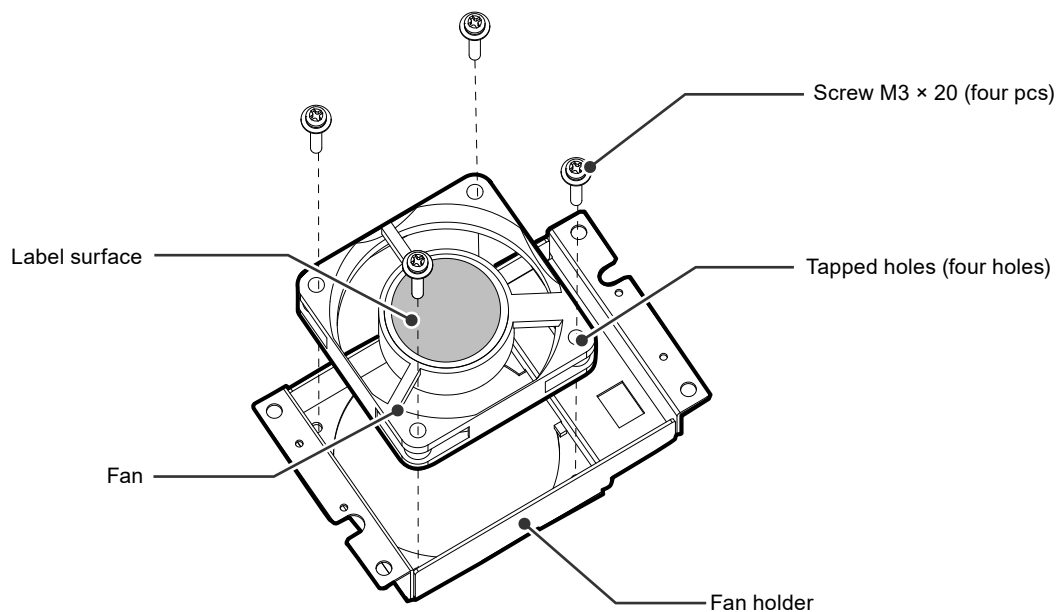

1. Remove the screws (four pcs) that secure the fan.  
Use a Phillips screwdriver to remove the screws.
2. Remove the fan.

### 4. Install a new fan in the fan holder.

**Attention**

- Handle the fan with care. Dropping or subjecting the fan to physical shock may damage it.
- Pay attention to the orientation of the fan when installing it.

1. Attach the fan to the holder using the screws removed in step 3 (page 39) (recommended torque:  $0.78 \pm 0.2 \text{ N}\cdot\text{m}$ ). Install the fan so that its label surface is oriented outwards.

## 5. Install the fan holder and fan cover.

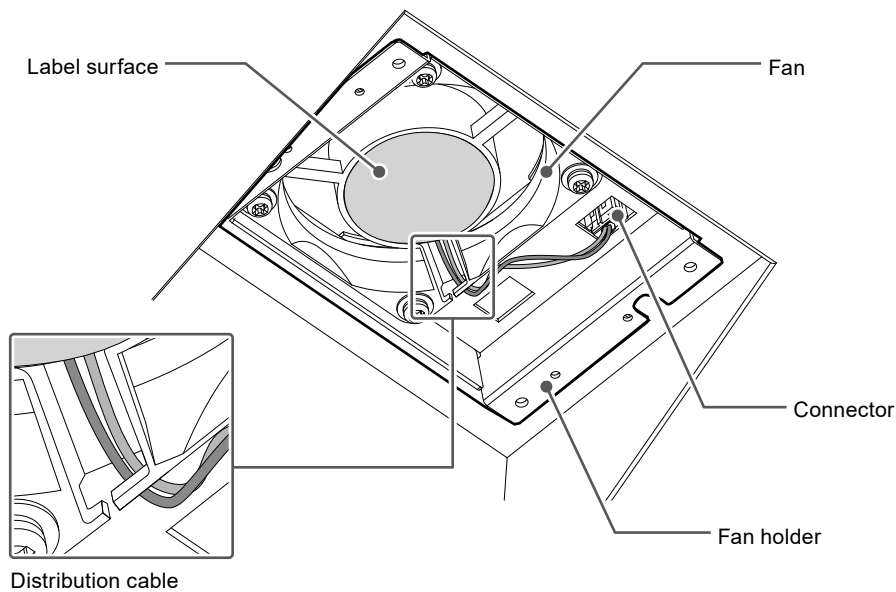

1. Install the holder on the monitor.
2. Connect the distribution cable to the monitor. Ensure the connector is connected to the monitor.
3. Route the distribution cable through the gap of the fan.
4. Attach the cover to the monitor using the screws removed in step 2 (page 38).

---

### Note

- After replacing the fan, perform the following procedure to check the operation:
  1. Confirm that the fan is rotating.
  2. Check that the message "WARNING: Fan not working" is not displayed on the screen.

**WARNING: Fan not working**

---

## Periodic check of buzzer alarm

---

- The buzzer installed in this monitor can be activated to emit warning beeps by system-side control.
- Check periodically to ensure that the warning beeps of the buzzer work. Use system-side control to check the buzzer.

---

### Note

- For details on system-side control, contact your local EIZO representative.
-





## **EIZO**株式会社

〒 924-8566 石川県白山市下柏野町 153 番地

## **EIZO** Corporation

153 Shimokashiwano, Hakusan, Ishikawa 924-8566 Japan

[www.eizo.co.jp](http://www.eizo.co.jp)  
[www.eizoglobal.com](http://www.eizoglobal.com)

Copyright © 2021 - 2022 EIZO Corporation. All rights reserved

## **EIZO** Europe GmbH

Belgrader Straße 2, 41069 Mönchengladbach, Germany

## 艺卓显像技术(苏州)有限公司

中国苏州市苏州工业园区展业路 8 号中新科技工业坊 5B

00N0N199B1  
SUM-MDU5501WT-AL

2nd Edition - August, 2022 Printed in Japan.